

IMPORTANT INFORMATION.

THE BEST COVERAGE IN AMERICA. Every 2009 Chevy passenger car, light-duty truck, SUV and crossover comes with a 100,000-mile/5-year (whichever comes first) transferable Powertrain Limited Warranty. Plus, you get 100,000 miles/5 years (whichever comes first) of 24/7 Roadside Assistance. Courtesy Transportation and much more. See dealer for details. Visit chevy.com/mediumduty/kodiak/warranty for Kodiak warranty information.

NEW VEHICLE LIMITED WARRANTY. GM vehicles registered in the U.S.A. are covered for 3 years/36,000 miles (whichever comes first). The complete vehicle is covered, including tires, towing to your nearest Chevrolet dealership and cosmetic corrosion resulting from defects. Repairs will be made to correct any vehicle defect, and most warranty repairs will be made at no charge. In addition, rust-through corrosion will be covered for 6 years/100,000 miles (whichever comes first). Powertrain components will be covered for 100,000 miles/5 years (whichever comes first). See dealer for details.

SILVERADO HYBRID WARRANTY. In addition to the transferable Chevy 36,000-mile/3-year (whichever comes first) New Vehicle Limited Warranty and the 100,000-mile/5-year (whichever comes first) Powertrain Limited Warranty, GM will also warrant certain hybrid components on Silverado Hybrid models for 100,000 miles/8 years (whichever comes first). No deductibles are associated with the Silverado Hybrid warranty, which is transferable to any subsequent persons assuming ownership of the vehicle during the 100,000-mile/8-year warranty period. See your Chevy dealer for details.

ENGINES. Chevrolet products are equipped with engines produced by GM Powertrain or other suppliers to GM worldwide. The engines in Chevrolet products may also be used in other GM makes and models.

WE'VE GOT YOUR BACK.

At Chevrolet, giving you a completely satisfying ownership experience is our top priority. That's why if you ever need assistance, feel free to contact us at these web sites or phone numbers.

CHEVY.COM. Offers shopping tools such as Build and Price, Find a Vehicle, Request Info., Email Sign-Up, Compare Vehicles, Financial Tools ... and much more.

24-HOUR ROADSIDE ASSISTANCE (1-800-CHEV-USA). Chevrolet Roadside Assistance provides you with the following services for 100,000 miles or 5 years (whichever comes first): Emergency Towing (to closest Chevy dealer from a legal roadway), Lockout Service (keys locked inside vehicle), Flat Tire Changes (spare installed), Fuel Delivery (\$5 worth of fuel delivered on the road) and Jump Starts (at home or on the road). For specific terms and conditions, please contact your Chevrolet Roadside Assistance advisor at 1-800-243-8872. Some services may incur costs.

COURTESY TRANSPORTATION. Ask your Chevrolet dealer for Courtesy Transportation if you leave your vehicle for extended repairs under the New Vehicle Limited Warranty or Powertrain Limited Warranty. Ask if you qualify for expense reimbursement and/or vehicle rental. Services vary by dealer.

ASSEMBLY. Chevrolet vehicles and their components are assembled or produced by different operating units of General Motors, its subsidiaries or suppliers to GM worldwide. We sometimes find it necessary to produce Chevrolet vehicles with different or differently sourced components than originally scheduled. Since some options may be unavailable when your vehicle is assembled, we suggest you verify that your vehicle includes the equipment you ordered and that, if there were changes, they are acceptable to you.

AN IMPORTANT NOTE ABOUT ALTERATIONS AND WARRANTIES. Installations or alterations to the original GM-equipped vehicle (or chassis) are not covered by the General Motors New Vehicle Limited Warranty. The special body company, assembler, equipment installer or upfitter is solely responsible for warranties on the body or equipment and any alterations (or any effect of the alterations) to any of the parts, components, systems or assemblies installed by GM. General Motors is not responsible for the safety or quality of design features, materials or workmanship of any alterations by such suppliers.

ONSTAR. OnStar services require vehicle electrical system (including battery), wireless service and GPS satellite signals to be available and operating for features to function properly. OnStar acts as a link to existing emergency service providers. Subscription Service Agreement required. Call 1-888-4ONSTAR (1-888-466-7827) or visit onstar.com for OnStar's Terms and Conditions, Privacy Policy, and details and system limitations. Additional information can be found in the OnStar Owner's Guide.

A NOTE ABOUT CHILD SAFETY. Always use safety belts and the correct child restraint for your child's age and size. Even in vehicles equipped with the Passenger Sensing System, children are safer when properly secured in a rear seat in the appropriate infant, child or booster seat. Never place a rear-facing infant restraint in the front seat of any vehicle equipped with an active air bag. Be sure every occupant is properly restrained. See the Owner's Manual and child safety seat instructions for more information.

CHEVROLET CUSTOMER ASSISTANCE CENTER (1-800-222-1020). Talk directly to customer relationship managers who can handle any inquiries related to vehicle operation, warranty coverages or product or service concerns you may have. Please refer to your Owner's Manual for Customer Assistance information.

CHEVY.COM/SAFETY. Chevrolet is committed to keeping you and your family safe — from the start of your journey to your destination. That's why every Chevrolet is designed with a comprehensive list of safety and security features to help give you peace of mind.

CHEVROLET OWNER CENTER (CHEVY.COM/MYGM LINK). Register your vehicle with the Chevrolet Owner Center and receive benefits such as online access to your vehicle Owner's Manual, maintenance schedule reminders, service history tracking, warranty and service information, safety information, special offers and privileges, and news and events.

09CHECOMCAT01

IMPORTANT WORDS ABOUT THIS CATALOG. We have tried to make this catalog comprehensive and factual. We reserve the right, however, to make changes at any time, without notice, in prices, colors, materials, equipment, specifications, models and availability. Specifications, dimensions, measurements, ratings and other numbers in this catalog and other printed materials provided at the dealership or affixed to vehicles are approximates based upon design and engineering drawings, prototypes and laboratory tests. Your vehicle may differ due to variations in manufacture and equipment. Since some information may have been updated since the time of printing, please check with your Chevrolet dealer for complete details. Chevrolet reserves the right to lengthen or shorten the model year for any product for any reason or to start and end model years at different times. Certain vehicle features may lose their usefulness over time due to obsolescence from technological changes. Unless otherwise noted, all claims based on GM segmentation and latest available competitive information. Excludes other GM vehicles.

TRAILERING AND OFF-ROAD INFORMATION. Please go to chevy.com and carefully review an Owner's Manual for important safety information about trailering or off-road driving in your vehicle.

MARKETING AND INCENTIVES (CHEVY.COM/SPECIALOFFERS). Call 1-800-950-CHEV (1-800-950-2438) or visit chevy.com/specialoffers for new product, current incentive and marketing program information.

GM CARD MEMBERS SERVICES.COM. Did you know about the family of reward credit cards that can help you get a great deal on a new GM car, light-duty truck, SUV or crossover? With a GM reward card, you accrue earnings on every credit card purchase to use toward the purchase or lease of an eligible, new GM vehicle. With three cards to choose from, you're sure to find one that suits you best.

GM, the GM Logo, Chevrolet, the Chevrolet Logo and the slogans, emblems, vehicle model names, vehicle body designs and other marks appearing in this catalog are the trademarks and/or service marks of General Motors Corporation, its subsidiaries, affiliates or licensors. The Bluetooth word mark is a registered trademark owned by Bluetooth SIG, Inc. and any use of such mark by Chevrolet is under license. Go to gm.com/bluetooth to find out which Bluetooth phones are compatible with the vehicle. Bose is a registered trademark of the Bose Corp. OnStar and Safe & Sound are registered service marks of OnStar Corp. ©2008 General Motors Corporation. All rights reserved.

Litho in USA.

July 2008

Please recycle where available ♻

09



CHEVY COMMERCIAL



AN AMERICAN REVOLUTION 



chevy.com/commercial 



CHEVROLET COMMERCIAL VEHICLES.

The backbone of every successful construction project is a solid commercial vehicle. | Chevy builds each vehicle with the power, strength and capability to get even the toughest work done. Choose from a wide range of hardworking commercial vehicles,

including pickups, vans, Kodiak C4500, Silverado HD and Express 4500. | To give you confidence that Chevy's Commercial Vehicles are up for almost anything, every 2009 Chevy car and light-duty truck is backed by the best coverage in America: a 100,000

mile/5-year¹ transferable Powertrain Limited Warranty, plus Roadside Assistance and Courtesy Transportation. | Chevy Trucks – still the most dependable, longest-lasting trucks on the road.²

¹ Whichever comes first. See dealer for details. ² Dependability based on longevity: 1981–July 2007 full-line light-duty truck company registrations. Excludes other GM divisions.

NOTE: The Express Cutaway Van on this page, as well as many of the vehicles found throughout this catalog, have been altered or modified with equipment from independent suppliers. Chevrolet is not responsible for the safety or quality of design features, materials or workmanship of any alterations by such a supplier. See back cover for more information about alterations and warranties.

THE VORTEC 2.9L I-4 AND VORTEC 3.7L I-5 ENGINES available in Colorado offer a broad torque curve with the majority of power coming between 2400 and 5700 rpm, providing ample torque at both low rpm and high rpm. The result: a truck that responds with what you need, when you need it.



A NEW HYDRA-MATIC SIX-SPEED AUTOMATIC TRANSMISSION is now available on select Silverado 1500 models. It features a GM-exclusive² Tap-Up/Tap-Down driver shift control (feature on the gear shift) that allows the driver to manually select upshifts and downshifts.

THE AVAILABLE DURAMAX 6.6L TURBO-DIESEL V8 offers 365 hp and 660 lb.-ft. of torque in Silverado HD models. Mate it with the Allison 1000 Series six-speed automatic transmission, and you have the most powerful heavy-duty pickup on the planet.³ Kodiak vehicles can also be equipped with the available Duramax 6.6L Turbo-Diesel offering 300 hp and 520 lb.-ft. of torque.



CHEVY COMMERCIAL POWERTRAINS.

Chevy Commercial vehicles offer a variety of engines to take on almost any task. | Choices range from the **VORTEC 2.9L I-4** in Colorado to the **DURAMAX 6.6L TURBO-DIESEL** available in Silverado, Express and Kodiak. | **ACTIVE FUEL MANAGEMENT**, available with the Vortec 5.3L V8 and Vortec 6.0L V8, smoothly shifts the engine from eight cylinders to four and back. | Available in select vehicles, the **VORTEC 5.3L FLEXFUEL AND THE 6.2L FLEXFUEL V8 ENGINES** operate on either gasoline or E85¹ – a blend of 85% ethanol and 15% gasoline – or a combination of both fuels. | Kodiak comes standard with the **325-HP VORTEC 8.1L BIG BLOCK V8**. | The Duramax 6.6L Turbo-Diesel V8 engine meets the Environmental Protection Agency's clean air requirements – making it the **CLEANEST DIESEL EVER OFFERED BY CHEVY.**

1 Go to chevy.com/biofuels to determine whether E85 fuel is available near you. 2 Based on 2008 GM Large Pickup segment. 3 Based on 3/4- and 1-ton vehicles in the 2008 GM Large Pickup segment. Excludes other GM vehicles.

Vortec 5.3L V8 with Active Fuel Management



COMMERCIAL TRUCK MODEL SELECTOR

Begin here to choose the Chevy Commercial vehicle for your business needs. Ask your Chevy dealer about financing options, Chevy Accessories and special offers just for commercial buyers.



GM BUSINESS CHOICE offers eligible commercial customers the choice of one of several upfits or other value-added offers with the purchase or lease of a new, eligible GM vehicle. For offer details, visit gmbusinesschoice.com.

CHEVY.COM provides several shopping and finance tools to help you find the right vehicle for the job. Also, visit chevy.com for special offers and to find a local Chevy dealer or a Business Central dealer near you that specializes in commercial vehicles.



BUSINESS CENTRAL DEALERS are dedicated to the needs of commercial customers. A specially trained sales staff can help you select from a full lineup of work-ready commercial vehicles – with many in inventory. They can also assist in outfitting your vehicle with specialized equipment from aftermarket companies. Find a Business Central dealer at chevybusinesscentral.com.



Colorado Regular Cab



Colorado Extended Cab



Colorado Crew Cab



Colorado Chassis Cab

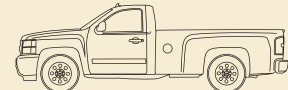

Silverado Regular Cab

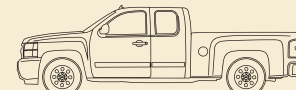

Silverado Extended Cab

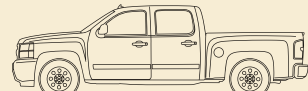

Silverado Crew Cab



Silverado Regular Cab Chassis Cab

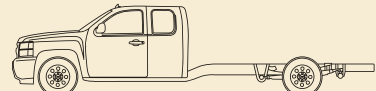

Silverado Extended Cab Chassis Cab

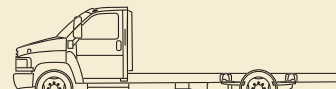

Kodiak Regular Cab Chassis Cab

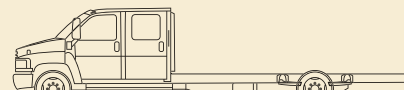

Kodiak Crew Cab Chassis Cab

CHEVY COMMERCIAL TRUCK MODEL	SERIES	CARGO BOX LENGTH (FT.)	WHEELBASE (WB) (IN.)	CAB-TO-AXLE LENGTH (IN.)	MAXIMUM PAYLOAD ¹ (LBS.) 2WD/4x4	STANDARD ENGINE	STANDARD HP @ RPM/TORQUE (LB.-FT.) @ RPM	OPTIONAL ENGINE
Colorado Regular Cab	—	6	111.3	33.9	1547/1535	Vortec 2.9L	185 @ 5600/190 @ 2800	Vortec 3.7L I-5
Colorado Extended Cab	—	6	126.0	34.2	1532/1523	Vortec 2.9L I-4	185 @ 5600/190 @ 2800	Vortec 3.7L I-5
Colorado Crew Cab	—	5	126.0	22.6	1316/1338	Vortec 2.9L I-4	185 @ 5600/190 @ 2800	Vortec 3.7L I-5
Colorado Chassis Cab	—	—	126.0	49.0	2142/1938	Vortec 3.7L I-5	242 @ 5600/242 @ 4600	Vortec 2.9L I-4 ²
Silverado Regular Cab	1500	6.5	119.0	41.9	1947/1722	Vortec 4.3L V6	195 @ 4600/260 @ 2800	Vortec 4.8L V8, Vortec 5.3L V8
	1500	8	133.0	55.9	1806/1854	Vortec 4.3L V6	195 @ 4600/260 @ 2800	Vortec 4.8L V8, Vortec 5.3L V8
	2500HD	8	133.0	55.9	3892/3646	Vortec 6.0L V8	360 @ 5400/380 @ 4200 ³	Duramax Diesel 6.6L V8
	3500HD SRW ⁴	8	133.0	55.9	4608/3654	Vortec 6.0L V8	360 @ 5600/380 @ 4200 ³	Duramax Diesel 6.6L V8
Silverado Extended Cab	3500 DRW ⁵	8	133.0	55.9	—/5307	Vortec 6.0L V8	322 @ 4400/380 @ 4200 ³	Duramax Diesel 6.6L V8
	1500	5.8	133.9	32.5	1606/1574	Vortec 4.3L V6 (2WD) Vortec 4.8L V8 (4x4)	195 @ 4600/260 @ 2800 295 @ 5600/305 @ 4600	Vortec 4.8L V8 (2WD only) Vortec 5.3L V8
	1500	6.5	143.5	41.9	1895/1855	Vortec 4.3L V6 (2WD) Vortec 4.8L V8 (4x4)	195 @ 4600/260 @ 2800 295 @ 5600/305 @ 4600	Vortec 4.8L V8 (2WD only) Vortec 5.3L V8
	1500	8	157.5	55.9	1736/1638	Vortec 5.3L V8	315 @ 5200/338 @ 4400	—
Silverado Crew Cab	2500HD	6.5	143.5	41.9	3604/3353	Vortec 6.0L V8	360 @ 5400/380 @ 4200	Duramax Diesel 6.6L V8
	2500HD	8	157.5	55.9	3456/3194	Vortec 6.0L V8	360 @ 5400/380 @ 4200 ³	Duramax Diesel 6.6L V8
	3500 SRW ⁴	8	157.5	55.9	4128/3880	Vortec 6.0L V8	360 @ 5400/380 @ 4200 ³	Duramax Diesel 6.6L V8
	3500 DRW ⁵	8	157.5	55.9	5127/4863	Vortec 6.0L V8	322 @ 4400/380 @ 4200 ³	Duramax Diesel 6.6L V8
	1500	5.8	143.5	32.5	1965/1921	Vortec 4.8L V8	295 @ 5600/305 @ 4600	Vortec 5.3L V8
Silverado Regular Cab Chassis Cab	2500HD	6.5	153.0	41.9	3458/3217	Vortec 6.0L V8	360 @ 5400/380 @ 4200	Duramax Diesel 6.6L V8
	2500HD	8	167.0	55.9	3301/3031	Vortec 6.0L V8	360 @ 5400/380 @ 4200 ³	Duramax Diesel 6.6L V8
	3500HD SRW ⁴	8	167.0	55.9	3621/3464	Vortec 6.0L V8	360 @ 5400/380 @ 4200 ³	Duramax Diesel 6.6L V8
	3500HD DRW ⁵	8	167.0	55.9	4979/4706	Vortec 6.0L V8	322 @ 4400/380 @ 4200 ³	Duramax Diesel 6.6L V8
Silverado Extended Cab Chassis Cab	3500HD	—	137.0, 161.5	60.4, 84.9	5655/6001 (137.0 WB) 5569/5954 (161.5 WB)	Vortec 6.0L V8	312 @ 4400/373 @ 4400	Duramax Diesel 6.6L V8
Silverado Regular Cab Chassis Cab	3500HD	—	161.5	60.4	5151/5475	Vortec 6.0L V8	312 @ 4400/373 @ 4400	Duramax Diesel 6.6L V8
Kodiak Regular Cab Chassis Cab	C4500	—	128, 152, 176, 188 (2WD) 152, 176, 188 (4x4)	60, 84, 108, 120 (2WD) 84, 108, 120 (4x4)	9021/10,452	Vortec 8.1L MD V8	325 @ 4000/450 @ 2800	Duramax Diesel 6.6L V8
Kodiak Crew Cab Chassis Cab	C4500	—	169, 194, 217, 229	60, 84, 108, 120	8229/9224	Vortec 8.1L MD V8	325 @ 4000/450 @ 2800	Duramax Diesel 6.6L V8
Kodiak Cutaway Chassis Cab	C4500	—	166, 184	100, 118	8345/9840	Vortec 8.1L MD V8	325 @ 4000/450 @ 2800	Duramax Diesel 6.6L V8

¹ Maximum payload capacity includes weight of driver, passengers, optional equipment and cargo. Cargo and load capacity limited by weight and distribution. ² Available only with Mid-Box Package. ³ 312 hp @ 4400 rpm and 373 lb.-ft. @ 4200 for box delete and incomplete vehicles. ⁴ Single rear wheel axle. ⁵ Dual rear-wheel axle.



SILVERADO 1500.

When all is said and done, it's all about the bottom line. Chevy lives by that same philosophy and proves it with 2008 Silverado models, which offer **BEST PROJECTED RESALE VALUE** of any new full-size pickup¹ two years running and 2008 Silverado half-ton having the **LOWEST COST OF OWNERSHIP** of any full-size pickup.² | The available Vortec 5.3L V8 engine offers **BETTER FUEL ECONOMY THAN ANY COMPETITOR**.³ | Choose from three cab configurations – Regular, Extended and Crew. | Four trim levels are available, including Work Truck (WT). | Available Hydra-Matic six-speed automatic transmission. | Opt for an Extended Cab model, and you'll get to experience **REAR DOORS THAT OPEN A FULL 170 DEGREES** – more than any other full-size truck.⁴ | Standard Vortec power under the hood. | The available Vortec 6.2L Flexfuel⁵ V8 engine offers **BEST-IN-CLASS 403 HP**.⁴ | Standard equipment includes a Tire Pressure Monitoring System, Driver Information Center (DIC) and OnStar⁶ with a one-year Safe & Sound Plan. | Silverado 1500 earned five-star frontal and side-impact crash test ratings.⁷ | Available features include the new rearview camera system, integrated trailer brake control and Bluetooth[®] wireless technology for select compatible phones.⁸

1 Based on *Automotive Lease Guide's* 2007 and 2008 Residual Value Awards. Excludes other GM vehicles. 2009 competitive data not available at time of printing. 2 Based on *Vincentric's* 2008 Model Analysis. 3 Based on 2008 GM Large Pickup segment and Silverado 2WD with EPA estimated MPG 14 city/20 hwy. Excludes other GM vehicles. 2009 competitive data not available at time of printing. 4 Based on 2008 GM Large Pickup segment. Excludes other GM vehicles. 5 Go to chevy.com/biofuels to see if there is an E85 fuel station near you. 6 Call 1-888-4ONSTAR (1-888-466-7827), visit onstar.com and see back cover for details and system limitations. 7 Side-impact crash test rating is for models tested with and without optional head-curtain side-impact air bags (SABs). Government star ratings are part of the National Highway Traffic Safety Administration's (NHTSA's) New Car Assessment Program (www.safercar.gov). 8 The Bluetooth word mark is a registered trademark owned by Bluetooth SIG, Inc. and any use of such mark by Chevrolet is under license. Go to gm.com/bluetooth to find out which Bluetooth phones are compatible with the vehicle.

SILVERADO 1500 SELECT SPECIFICATIONS S = STANDARD O = OPTIONAL – = NOT AVAILABLE

ENGINE AVAILABILITY	HP @ RPM	TORQUE (LB.-FT.) @ RPM	REG. CAB	EXT. CAB	CREW CAB
Vortec 4.3L V6	195 @ 4600	260 @ 2800	S ¹	S ¹	–
Vortec 4.8L V8	295 @ 5600	305 @ 4600	S ²	S ³	S ⁴
Vortec 5.3L V8	315 @ 5200	338 @ 4400	O	S ⁵	S ⁶
Vortec 5.3L FlexFuel V8 ⁷	315 @ 5200	338 @ 4400	O	O	O
Vortec 6.0L V8	367 @ 5600	375 @ 4300	–	O	O
Vortec 6.2L FlexFuel V8 ⁷	403 @ 5700	417 @ 4300	–	–	O ⁶

TRANSMISSION/TRANSFER CASE AVAILABILITY	REG. CAB	EXT. CAB	CREW CAB
Hydra-Matic four-speed OD automatic with Tow/Haul mode	S	S	S
Hydra-Matic six-speed automatic with Tow/Haul mode	–	O ⁸	O ⁹
Transfer case: two-speed, floor-mounted (4x4 only)	S	S	S
Transfer case: active, Autotrac with electronic shift (4x4 only)	O	O	O

CHASSIS FEATURES	REG. CAB	EXT. CAB	CREW CAB
Alternator: – 145-amp	S	S	S
– 160-amp (requires Snow Plow Prep Package)	O	–	–
Brakes: four-wheel ABS with Dynamic Rear Proportioning	S	S	S
– front rotor diameter and thickness (in.)	13.0 x 1.2	13.0 x 1.2	13.0 x 1.2
– rear drum diameter and width (in.)	11.6 x 2.4	11.6 x 2.4	11.6 x 2.4
Steering: power rack-and-pinion	S	S	S

1 Work Truck models only. 1500 Regular Cab Standard Box, 1500 Regular Cab Long Box, 1500 Extended Cab Short Box 2WD and 1500 Extended Cab Standard Box 2WD models only. 2 Standard in LT models. 3 Standard in 2WD Short and Standard Box and in all 4x4 short and standard box LT models. 4 Standard in WT, LS and LT models. 5 Standard in LTZ models. Not available in 1500 Extended Cab Long Box models. 6 LTZ models only. 7 E85 fuel is 85% ethanol, 15% gasoline. Go to chevy.com/biofuels to see if there is an E85 fuel station near you. 8 Included and only available with Vortec 6.0L V8 engine. 9 Included and only available with Vortec 5.3L V8, Vortec 6.0L V8 and Vortec 6.2L FlexFuel V8 engines.



HEAD-CURTAIN SIDE-IMPACT AIR BAGS¹ – available in 1500 models – help reduce the risk of injuries to all outboard occupants in certain side impacts. Deployed upon sensing a rollover, side impact or second-stage frontal impact, these air bags cover the first and second outboard rows of Crew Cab and Extended Cab models or the driver and outboard passenger of Regular Cab models.

1 Air bag inflation can cause serious injury or death to anyone too close to the air bag when it deploys. Be sure every occupant is properly restrained.

SILVERADO 2500HD & 3500HD.

Combine the Silverado HD with the available Duramax Diesel V8 and the Allison 1000 Series six-speed automatic transmission offering 365 horsepower and 660 lb.-ft. of torque, and you have the **MOST POWERFUL HEAVY-DUTY PICKUP ON THE PLANET.**¹ | Standard Hydra-Matic six-speed automatic transmission comes standard with the Vortec 6.0L V8 engine. | Each transmission features **TAP-UP/TAP-DOWN DRIVER SHIFT CONTROL**, auto grade-braking and Tow/Haul mode. | With 2WD and 4x4 models available, three different cab configurations and both single and dual rear wheel offerings, you have **21 CAB/BOX/DRIVE/REAR-WHEEL COMBINATIONS** to choose from. | 2500HD and 3500HD can be equipped with the GM segment-exclusive² automatic locking rear differential. | With integrated Bluetooth[®] wireless technology for select compatible phones³ on LTZ models, you can answer and end calls without touching your mobile phone – because now most Bluetooth-compatible cell phones can be paired to the vehicle. And as an incoming call is answered, the vehicle's audio system is conveniently and automatically muted.

¹ Based on 3/4- and 1-ton vehicles in the 2008 GM Large Pickup segment. Excludes other GM vehicles. ² Based on 2008 GM Large Pickup segment. ³ The Bluetooth word mark is a registered trademark owned by Bluetooth SIG, Inc. and any use of such mark by Chevrolet is under license. Go to gm.com/bluetooth to find out which Bluetooth phones are compatible with the vehicle.

SILVERADO 2500HD/3500HD SELECT SPECIFICATIONS S = STANDARD O = OPTIONAL – = NOT AVAILABLE

ENGINE AVAILABILITY	HP @ RPM	TORQUE (LB.-FT.) @ RPM	REG. CAB	EXT. CAB	CREW CAB
Vortec 6.0L V8 (SRW)	360 @ 5400 ¹	380 @ 4200 ¹	S	S	S
Vortec 6.0L V8 (DRW) ²	322 @ 4400 ¹	380 @ 4200 ¹	S	S	S
Duramax Diesel 6.6L V8 ³	365 @ 3200	660 @ 1600	O	O	O
TRANSMISSION/TRANSFER CASE AVAILABILITY					
Hydra-Matic six-speed automatic overdrive with Tap-Up/Tap-Down driver shift control, auto grade-braking and Tow/Haul mode ⁴			S	S	S
Allison 1000 Series six-speed automatic overdrive with Tap-Up/Tap-Down driver shift control, auto grade-braking and Tow/Haul mode ⁵			O	O	O
Transfer case: two-speed, floor-mounted (4x4 only)			S ⁶	S ⁶	S ⁶
Transfer case: electronic-shift, instrument panel-mounted (4x4 only)			O	O	O
CHASSIS FEATURES					
Alternator: – 125-amp			S	S	S
– dual 125-amp			O ⁵	O ⁵	O ⁵
– 160-amp			O ⁴	O ⁴	O ⁴
Suspension, front: independent with torsion bars			S	S	S
Suspension, rear: hypoid drive axle (two-stage multileaf springs)			S	S	S

SRW – Single rear wheel. DRW – Dual rear wheel.

¹ 312 hp @ 4400 rpm and 373 lb.-ft. of torque @ 4200 for box delete and incomplete vehicles. ² 3500HD models only. ³ Requires available Allison 1000 Series six-speed automatic transmission. Includes dual, heavy-duty, 730 cold-cranking-amp batteries and engine block heater. ⁴ Requires Vortec 6.0L V8 engine. ⁵ Requires available Duramax Diesel 6.6L V8 Turbo engine. ⁶ Work Truck models only.



AN INTEGRATED TRAILER BRAKE CONTROLLER with instrument panel-mounted control is available on Silverado 1500, 2500HD and 3500HD models. Integrated with the ABS, the controller provides immediate and measured brake force signaling to the electric-controlled trailer brake system. Since it's fully integrated with the vehicle's ABS and electric system, there is no requirement for external and/or aftermarket brake control systems.



Silverado 3500HD Big Dooley Crew Cab Long Box LTZ 4x4 in Black. Shown with available features.



SILVERADO 3500HD CHASSIS CAB.

Silverado Chassis Cab is a great foundation for upfitting by an independent supplier.¹ | Two engines are available to power the Chassis Cab models – the standard Vortec 6.0L V8 engine and available Duramax Diesel 6.6L V8 engine that offers **BEST-IN-CLASS² HD HORSEPOWER** and overall torque. | Transmission availability depends on the engine selected. The six-speed heavy-duty OD automatic transmission comes standard with the Vortec 6.0L V8 and the **ALLISON 1000 SERIES SIX-SPEED AUTOMATIC TRANSMISSION** is mated to the Duramax Diesel. | Each transmission features the Tow/Haul mode, and the Allison transmission comes with Tap-Up/Tap-Down driver shift controls and auto grade-braking, and provides **POWER TAKEOFF (PTO) CAPABILITY³** | HD vehicles offer GVWRs⁴ up to 11,400 lbs. (2WD) and 12,000 lbs. (4x4). | Each Chassis Cab comes standard with four-wheel ventilated disc brakes with ABS and Dynamic Rear Proportioning. | Extended Cab models offer seating for up to six.

¹ See back cover for more information about alterations and warranties. ² Based on 3/4- and 1-ton vehicles in the 2008 GM Large Pickup segment. Excludes other GM vehicles. ³ Some optional equipment is required for PTO installation. ⁴ Gross Vehicle Weight Rating (GVWR). When properly equipped; includes weight of vehicle, driver, passengers, cargo and optional equipment.

SILVERADO CHASSIS CAB SELECT SPECIFICATIONS S = STANDARD O = OPTIONAL - = NOT AVAILABLE

ENGINE AVAILABILITY	HP @ RPM	TORQUE (LB.-FT.) @ RPM	3500HD
Vortec 6.0L V8	312 @ 4400	373 @ 4400	S
Duramax Diesel 6.6L V8 ¹	365 @ 3200	660 @ 1600	O
TRANSMISSION/TRANSFER CASE AVAILABILITY			
Six-speed heavy-duty OD automatic with Tow/Haul mode			S
Allison six-speed automatic with electronic engine grade braking and Tow/Haul mode (available with Duramax V8 only)			O
Transfer case: two-speed, floor-mounted (WT trim level and 4x4 only)			S
Transfer case: electronic-shift, instrument panel-mounted (4x4 only)			O
CHASSIS FEATURES			
Alternator: 125-amp (160-amp with available Snow Plow Prep Package)			S
Brakes: four-wheel ABS with Dynamic Rear Proportioning			S
– front rotor diameter and thickness (in.)			12.8 x 1.5
– rear rotor diameter and thickness (in.)			12.8 x 1.2
Differential: automatic locking rear			O ²
Steering: integral power, recirculating ball			S
Suspension, front: independent torsion bar			
– 2WD Gross Axle Weight Rating range (lbs.)			4500–4800
– 4x4 Gross Axle Weight Rating range (lbs.)			4800
Suspension, rear: hypoid drive axle (with two-stage main/auxiliary multileaf springs)			S
– 2WD Gross Axle Weight Rating (lbs.)			9000
– 4x4 Gross Axle Weight Rating (lbs.)			8600

¹ Not available with 2WD Regular Cab Long Box with Single Rear Wheel. Includes heavy-duty dual, 730 cold-cranking-amp batteries and engine block heater. ² Only available with LT trim.



POWER TAKEOFF (PTO) capability allows HD Chassis Cab models equipped with the GM-exclusive¹ available Allison six-speed automatic transmission to power auxiliary equipment such as a dump body or hydraulic motors for generators or tools.

¹ Based on 2008 GM Large Pickup segment.



After years of building the most dependable, longest-lasting trucks on the road,¹ we're now the first manufacturer to bring you a production two-mode hybrid full-size pickup.

CHEVY SILVERADO HYBRID.

No current technology defines Silverado's commitment to alternative fuels better than the **SILVERADO TWO-MODE HYBRID** (scheduled to begin production late 2008 with limited availability) – **AMERICA'S FIRST TWO-MODE HYBRID FULL-SIZE PICKUP.** | Silverado Two-Mode Hybrid will provide the dependability, power and performance you demand in a Chevy Truck. Plus, it's engineered to feature cutting-edge technology to help you through the rigors of your everyday life while being conscious of the environment. | In Mode 1, at low speeds and with light loads, the truck can operate three ways – electric power, engine power or a combination of the two. When the truck operates on electric power, you receive all the benefits of a full hybrid system. | Mode 2, used primarily at highway speeds, provides electric assist, in addition to four-cylinder or full eight-cylinder engine power when conditions demand it. | Drivers will experience the benefit of excellent efficiency² while also having access to the Vortec 6.0L V8 with 332 horsepower and 367 lb.-ft. of torque. | In either mode, it's a truck that works in the real world when being driven by real people, and it's one of the many ways Chevy is working to produce a variety of fuel solutions.

¹ Dependability based on longevity: 1981–July 2007 full-line light-duty truck company registrations. Excludes other GM divisions. ² EPA estimated MPG 21 city/22 highway 2WD and 20 city/20 highway on 4x4 models.



Silverado 1500 Crew Cab Hybrid 4x4 in Silver Birch Metallic.

KODIAK C4500 CHASSIS CABS.

Chevy Kodiak is designed to give commercial customers the medium-duty strength to help get the largest jobs done. | The C4500 comes standard with the **325-HP VORTEC 8.1L MD BIG BLOCK V8 ENGINE**. Opt for the Duramax 6.6L Turbo-Diesel engine, and you'll have up to 330 hp and 620 lb.-ft. of torque. | No matter which engine you select, it will be mated to an Allison six-speed 1000 Series transmission or an available Allison 2350 Series transmission that allows up to a 30,000-lb. GCWR!¹ | Available Allison 1000 and 2350 Rugged Duty Series (RDS) transmissions include provisions for Power Takeoff (PTO).² Ask your dealer for details. | Kodiak is available in Regular Cab or Crew Cab, in both 2WD or 4WD models. | A 2WD Commercial Cutaway and Motorhome Cutaway Chassis are also available. | The 4WD models come standard with a limited slip rear differential.

¹Gross Combination Weight Rating. ²Some optional equipment is required for PTO installation by an independent supplier. The provisions for PTO include an instrument panel switch, an electrical interface and an internal PTO gear in the transmission. NOTE: The Kodiak Chassis illustrated includes a pickup body installation from the independent supplier. Chevrolet is not responsible for the safety or quality of design features, materials or workmanship of any alterations by such a supplier. See back cover for more information about alterations and warranties.

KODIAK SELECT SPECIFICATIONS S = STANDARD O = OPTIONAL - = NOT AVAILABLE

ENGINE AVAILABILITY	HP @ RPM	TORQUE (LB.-FT.) @ RPM	REG. CAB	CREW CAB
Vortec 8.1L MD V8	325 @ 4000	450 @ 2800	S	S
Duramax Diesel 6.6L V8	330 @ 3000	620 @ 1600	O	O
Duramax Diesel 6.6L V8	300 @ 3000	520 @ 1600	O	O
TRANSMISSION/TRANSFER CASE AVAILABILITY				
Allison 1000 Series six-speed automatic			S	S
Allison 2350 Rugged Duty Series (RDS) six-speed automatic			O	O
Transfer case: two-speed, electronic-shift, instrument panel-mounted (4x4 only)			S	S
CHASSIS FEATURES				
Alternator: 150-amp			S	S
Battery: 600-cca ¹ (dual 750-cca batteries with Duramax Diesel engine)			S	S
Brakes, hydraulic: four-wheel ventilated disc			S	S
Mirrors: folding, cowl-mounted, 7-in. x 12-in. rearview, with an additional 7-in. x 6-in. convex mirror			S	S
Power Takeoff (PTO) capability			O ²	O ²
Steering: variable-ratio power, recirculating ball			S	S

¹Cold-cranking amps. ²Some optional equipment is required for PTO installation by an independent supplier. The provisions for PTO include an instrument panel switch, an electrical interface and an internal PTO gear in the transmission.

THE KODIAK CREW CAB PICKUP offers seating for six and provides plenty of strength for towing fifth-wheel or ball-hitch trailers. The Kodiak C4500's flat frame rails allow for many types of upfits in addition to the pickup conversion. Visit chevy.com for more information. Some equipment shown is from an independent supplier. See back cover for more information about alterations and warranties.



Kodiak Chassis Cab in Dark Blue Metallic with equipment from an independent supplier. See back cover for more information about alterations and warranties.



COLORADO PICKUPS AND CHASSIS CAB.

Chevy Colorado comes from the family of the most dependable, longest-lasting trucks on the road¹ – so you know they will be there until the job is done. | Colorado offers **THREE CAB CONFIGURATIONS** – Crew, Extended and Regular. | **THREE ENGINE CHOICES:** Vortec 2.9L I-4, Vortec 3.7L I-5 and the 300-hp Vortec 5.3L V8. | Choose between Pickup and Chassis Cab models. | Standard StabiliTrak Electronic Stability Control System (includes Traction Control). | And the bedliner is now standard on every model. | Colorado features an innovative tailgate that can be removed and placed in two different open positions.

¹ Dependability based on longevity: 1981-July 2007 full-line light-duty truck company registrations. Excludes other GM divisions.

THE VORTEC 5.3L V8 ENGINE joins the lineup of Vortec engines available for the Chevy Colorado. It delivers 300 horsepower and 320 lb.-ft. of torque and is available in Extended and Crew Cab models only.

COLORADO SELECT SPECIFICATIONS S = STANDARD O = OPTIONAL – = NOT AVAILABLE

ENGINE AVAILABILITY	HP @ RPM	TORQUE (LB.-FT.) @ RPM	REGULAR CAB	CHASSIS CAB	EXTENDED CAB	CREW CAB
Vortec 2.9L I-4	185 @ 5600	190 @ 2800	S	O ¹	S	S
Vortec 3.7L I-5	242 @ 5600	242 @ 4600	O	S	O	O
Vortec 5.3L V8	300 @ 5200	320 @ 4000	–	–	O	O
TRANSMISSION/TRANSFER CASE AVAILABILITY						
Five-speed heavy-duty OD manual			S	S	S	S
Hydra-Matic four-speed OD automatic			O	O	O	O
Transfer case: Insta-Trac, instrument panel-mounted (4x4 only)			S	–	S	S
Traction Control system (2WD only)			O	O	O	O
CHASSIS FEATURES						
Alternator: 125-amp			S	S	S	S
Differential: automatic locking rear			O	O	O	O
Steering: power rack-and-pinion			S	S	S	S
Suspension: independent front with coil springs on 2WD and torsion bars on 4x4:			S	S	S	S
– axle capacity (2WD/4x4, lbs.)			2633/2850	2850/2850	2633/2850	2633/2850
– spring capacity (2WD/4x4, lbs.)			2633/2850	2850/2850	2633/2850	2633/2850

¹ Available only with Mid-Box Package from an independent supplier. See back cover for more information about alterations and warranties.



COLORADO REGULAR CAB in Summit White.



COLORADO CHASSIS CAB in Summit White shown with an aluminum flat bed and other available equipment from an independent supplier.



COLORADO CHASSIS CAB in Summit White shown with the available Mid-Box Package and other available equipment from an independent supplier.

COMMERCIAL VAN MODEL SELECTOR.

Begin here to choose the 2009 HHR Panel or full-size Express Commercial Van model that's right for your business needs. Then visit a Chevy dealer to shop and learn more about financing options, Chevy Accessories and special offers just for commercial customers.



GM BUSINESS CHOICE offers eligible commercial customers the choice of one of several upfits or other value-added offers with the purchase or lease of a new, eligible GM vehicle. For offer details, visit gmbusinesschoice.com.

CHEVY.COM provides several shopping and finance tools to help you find the right vehicle for the job. Also, visit chevy.com for special offers and to find a local Chevy dealer or a Business Central dealer near you that specializes in commercial vehicles.



BUSINESS CENTRAL DEALERS are dedicated to the needs of commercial customers. A specially trained sales staff can help you select from a full lineup of work-ready commercial vehicles – with many in inventory. They can also assist in outfitting your vehicle with specialized equipment from aftermarket companies. Find a Business Central dealer at chevybusinesscentral.com.



HHR Panel

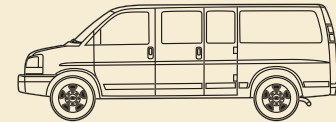

Express Cargo Van

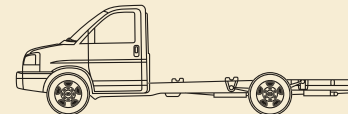

Express Commercial Cutaway

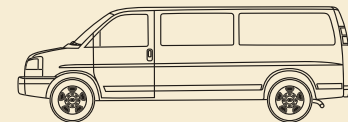

Express Passenger Van

CHEVY COMMERCIAL VAN MODELS	TRIM/SERIES	DRIVE	WHEELBASE (WB)(IN.)	STANDARD ENGINES	STANDARD HP @ RPM/TORQUE (LB.-FT.) @ RPM	OPTIONAL ENGINES	MAXIMUM PAYLOAD (LBS.) ¹	CARGO SPACE (CU. FT.) ²	STANDARD SEATING	OPTIONAL SEATING
HHR Panel	LS/1LT	FWD	103.6	2.2L 4-cyl.	155 @ 6100/150 @ 4800	2.2L FlexFuel 4-cyl.	1174	62.7	2	-
	2LT	FWD	103.6	2.4L 4-cyl.	172 @ 5800/167 @ 4500	2.4L FlexFuel 4-cyl.	1174	62.7	2	-
Express Work Van	1500 Regular	RWD	135	Vortec 4.3L V6	195 @ 4600/260 @ 2800	Vortec 5.3L V8	2306	225.1	2	1
	1500 AWD Regular	AWD	135	Vortec 5.3L V8	301 @ 5200/325 @ 4500	Vortec FlexFuel 5.3L V8	2121	225.1	2	1
	2500HD Regular	RWD	135	Vortec 4.8L V8	279 @ 5200/294 @ 4500	Vortec 6.0L V8 Duramax Diesel 6.6L V8	3262	225.1	2	1
	2500HD Extended	RWD	155	Vortec 4.8L V8	279 @ 5200/294 @ 4500	Vortec 6.0L V8 Duramax Diesel 6.6L V8	3053	261.6	2	1
	3500 Regular	RWD	135	Vortec 4.8L V8	279 @ 5200/294 @ 4500	Vortec 6.0L V8 Duramax Diesel 6.6L V8	4147	225.1	2	1
3500 Extended	RWD	155	Vortec 4.8L V8	279 @ 5200/294 @ 4500	Vortec 6.0L V8 Duramax Diesel 6.6L V8	3958	261.6	2	1	
Express Commercial Cutaway	3500	RWD	139	Vortec 4.8L V8 ³	279 @ 5200/294 @ 4500	Vortec 6.0L V8 Duramax Diesel 6.6L V8	5072	—	2	1
	3500	RWD	139	Vortec 4.8L V8 ⁴	258 @ 4600/294 @ 4500	Vortec 6.0L V8 Duramax Diesel 6.6L V8	5072	—	2	1
	3500	RWD	159/177	Vortec 6.0L V8	323 @ 4600/373 @ 4400	Duramax Diesel 6.6L V8	5152/7105	—	2	1
	4500	RWD	159	Vortec 6.0L V8	323 @ 4600/373 @ 4400	Duramax Diesel 6.6L V8	9050	—	2	1
Express Passenger Van	1500 Regular	RWD	135	Vortec 5.3L V8	301 @ 5200/325 @ 4500	Vortec FlexFuel 5.3L V8	1905	204.0 ⁵	8	—
	1500 AWD Regular	AWD	135	Vortec 5.3L V8	301 @ 5200/325 @ 4500	Vortec FlexFuel 5.3L V8	1707	204.0 ⁵	8	—
	2500	RWD	135	Vortec 6.0L V8	323 @ 4600/373 @ 4400	—	2708	204.0 ⁵	12	8
	3500 Regular	RWD	135	Vortec 6.0L V8	323 @ 4600/373 @ 4400	—	3591	204.0 ⁵	12	8
	3500 Extended	RWD	155	Vortec 6.0L V8	323 @ 4600/373 @ 4400	—	3270	236.3 ⁵	12	15

¹ Maximum payload capacity includes weight of driver, passengers, optional equipment and cargo. Higher payloads (where available) require optional equipment. ² Cargo and load capacity limited by weight and distribution. ³ Vehicles less than 10,000 pounds. ⁴ Vehicles greater than 10,000 pounds. ⁵ With all rear passenger seats removed.

EXPRESS 1500, 2500 AND 3500 WORK VANS.

Express Work Van offers an **UNMATCHED SELECTION OF ENGINES¹** ranging from the gasoline-powered Vortec 4.3L V6 to the Duramax 6.6L Turbo-Diesel V8 engine – the **MOST POWERFUL DIESEL IN ITS CLASS¹** | Also available to power the Express is the Vortec 5.3L FlexFuel V8.² | The Work Vans come standard with numerous features, including power steering, four-wheel antilock disc brakes, Oil-Life Monitor and Tow/Haul mode. | The Driver Information Center (DIC) provides maintenance reminders along with many other functions. | Available features include locking rear differential, **ALL-WHEEL-DRIVE (AWD)** on 1500 models – a GM exclusive¹ – and head-curtain side-impact air bags.³

¹ Based on 2008 GM Large Van segment and latest available competitive information. Excludes other GM vehicles. ² E85 is 85% ethanol, 15% gasoline. Go to chevy.com/biofuels to see if there is an E85 fuel station near you. ³ Always use safety belts and the correct child restraint for your child's age and size. Even in vehicles equipped with the Passenger Sensing System, children are safer when properly secured in a rear seat in the appropriate infant, child or booster seat. Never place a rear-facing infant restraint in the front seat of any vehicle equipped with an active air bag. See the Owner's Manual and child safety seat instructions for more safety information.

CHEVY EXPRESS WORK VAN SELECT SPECIFICATIONS S = STANDARD O = OPTIONAL -- = NOT AVAILABLE

ENGINE AVAILABILITY	HP @ RPM	TORQUE (LB.-FT.) @ RPM	1500	1500 AWD	2500HD	2500HD EXT	3500	3500 EXT
Vortec 4.3L V6	195 @ 4600	260 @ 2800	S	--	--	--	--	--
Vortec 4.8L V8	279 @ 5200	294 @ 4500	--	--	S	S	S	S
Vortec 5.3L V8	301 @ 5200	325 @ 4500	O	S	--	--	--	--
Vortec 5.3L FlexFuel V8	301 @ 5200	325 @ 4500	O	O	--	--	--	--
Vortec 6.0L V8	323 @ 4600	373 @ 4400	--	--	O	O	O	O
Duramax Diesel 6.6L V8	250 @ 3200	460 @ 1600	--	--	O	O	O	O
TRANSMISSION AVAILABILITY								
Hydra-Matic four-speed OD automatic with Tow/Haul mode			S	S	--	--	--	--
Hydra-Matic heavy-duty four-speed OD automatic with Tow/Haul mode			--	--	S	S	S	S
CHASSIS FEATURES								
Alternator: -- 125-amp			S ¹	S	--	--	--	--
-- 145-amp			S ²	--	--	--	--	--
-- 105-amp			--	--	S	S	S	S
Battery: -- 600-cca ³			S	S	S	S	S	S
-- high-capacity 770-cca ³			O	O	O ⁴	O ⁴	O ⁴	O ⁴
Brakes: -- power hydraulic four-wheel ventilated disc			S	S	S	S	S	S
-- four-wheel antilock brake system (ABS) with Dynamic Rear Proportioning			S	S	S	S	S	S
-- front rotor diameter and thickness (in.)			12.0 x 1.1	12.0 x 1.1	12.8 x 1.5	12.8 x 1.5	12.8 x 1.5	12.8 x 1.5
-- rear rotor diameter and thickness (in.)			13.0 x 1.2	13.0 x 1.2	13.0 x 1.1	13.0 x 1.1	13.0 x 1.1	13.0 x 1.1
Differential: automatic locking rear			O	O	O	O	O	O
Suspension, front: -- independent (coil springs on RWD models and torsion bars on available AWD models)			S	S	S	S	S	S
-- axle/torsion bar capacity (lbs.)			3600	3600	4100	4300	4300	4300
Suspension, rear: -- hypoid drive axle with two-stage leaf springs			S	S	S	S	S	S
-- axle capacity (lbs.)			4000	4000	5360	5360	6084	6084

¹ Standard with Vortec 5.3L V8 engine. ² Standard with Vortec 4.3L V6 engine. ³ Cold-cranking amps. ⁴ Duramax Diesel standard with dual 770-cca batteries.



AVAILABLE ACCESS PACKAGES offer easy interior access to tools and cargo. Each includes three exterior, remote-release, side-access panels accessed by Remote Keyless Entry. Not available with 60/40 driver-side doors.



Chevy Express 1500 AWD Work Van in Summit White. Shown with available features.

EXPRESS PASSENGER VAN.

Available in 8-, 12- AND 15-PASSENGER SEATING configurations, Express Passenger Van offers room for a family, small choir or even an entire basketball team. | It is available in 1500, 1500 All-Wheel-Drive (AWD), 2500, 3500 and 3500 Extended Wheelbase models. | The Passenger Van comes with standard safety features that include head-curtain side-impact air bags,¹ a Tire Pressure Monitoring System, **ENHANCED TECHNOLOGY GLASS (ETG),²** StabiliTrak Electronic Stability Control System and an antilock brake system with Dynamic Rear Proportioning. | The available All-Wheel-Drive (AWD) on 1500 models is a GM exclusive.³ | The engine lineup includes the Vortec 5.3L V8 (standard in 1500 and 1500 AWD), the available Vortec 5.3L FlexFuel V8,⁴ and the Vortec 6.0L V8 (standard in 2500, 3500 and 3500 Extended Wheelbase models).

¹ Always use safety belts and the correct child restraint for your child's age and size. Even in vehicles equipped with the Passenger Sensing System, children are safer when properly secured in a rear seat in the appropriate infant, child or booster seat. Never place a rear-facing infant restraint in the front seat of any vehicle equipped with an active air bag. See the Owner's Manual and child safety seat instructions for more safety information. Located in rows one through three. ² Standard in 12- and 15-passenger models only. ETG is part of the overall occupant protection system on passenger vans. ETG may help to keep passengers sitting next to these windows from being ejected through the glass in some, but not in all, crashes. Even with this glass, seat belts must be worn at all times. For passenger vans, use only ETG glass approved for your vehicle for replacement when damaged. ³ Based on 2008 GM Large Van segment and latest available competitive information. Excludes other GM vehicles. ⁴ Available in 1500 models only. E85 is 85% ethanol, 15% gasoline. Go to chevy.com/biofuels to determine whether E85 fuel is available near you.

CHEVY EXPRESS PASSENGER VAN SELECT SPECIFICATIONS S = STANDARD O = OPTIONAL -- = NOT AVAILABLE

ENGINE AVAILABILITY	HP @ RPM	TORQUE (LB.-FT.) @ RPM	1500	1500 AWD	2500	3500	3500 EXT
Vortec 5.3L V8	301 @ 5200	325 @ 4500	S	S	--	--	--
Vortec 5.3L FlexFuel V8	301 @ 5200	325 @ 4500	O	O	--	--	--
Vortec 6.0L V8	323 @ 4600	373 @ 4400	--	--	S	S	S
TRANSMISSION AVAILABILITY							
Hydra-Matic four-speed OD automatic with Tow/Haul mode			S	S	--	--	--
Hydra-Matic heavy-duty four-speed OD automatic with Tow/Haul mode			--	--	S	S	S
CHASSIS FEATURES							
All-Wheel-Drive (AWD)			--	S	--	--	--
Alternator: -- 145-amp			S	S	--	--	--
-- 105-amp			--	--	S	S	S
Brakes: -- power hydraulic four-wheel ventilated disc			S	S	S	S	S
-- four-wheel antilock brake system (ABS) with Dynamic Rear Proportioning			S	S	S	S	S
-- front rotor diameter and thickness (in.)			12.0 x 1.1	12.0 x 1.1	12.8 x 1.5	12.8 x 1.5	12.8 x 1.5
-- rear rotor diameter and thickness (in.)			13.0 x 1.2	13.0 x 1.2	13.0 x 1.1	13.0 x 1.1	13.0 x 1.1
Oil-Life Monitor			S	S	S	S	S
StabiliTrak Electronic Stability Control System			S	S	S	S	S
Steering: power			S	S	S	S	S
Suspension, front: -- independent (coil springs on rear-wheel-drive models and torsion bars on available AWD models)			S	S	S	S	S
-- axle/torsion bar capacity (lbs.)			3700	3600	4100	4300	4300
Suspension, rear: -- hypoid drive axle with multileaf springs			S	S	S	S	S
-- axle capacity (lbs.)			4000	4000	5360	6084	6084
-- spring capacity (lbs.)			4000	4000	5360	6084	6084

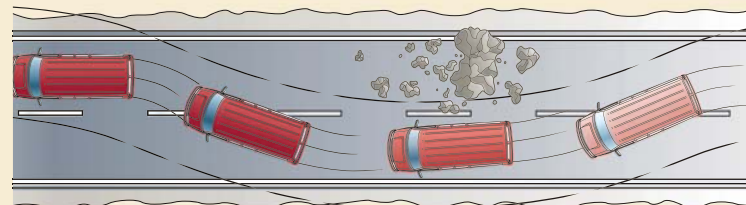

THE STABILITRAK ELECTRONIC STABILITY CONTROL SYSTEM helps improve stability, particularly on slick surfaces and during emergency maneuvers. Visit chevy.com/express/safety for more information on how StabiliTrak works.



Chevy Express 3500 Extended Wheelbase Passenger Van in Silver Birch Metallic (extra-cost color). Shown with available features.

CHEVY EXPRESS 4500 CUTAWAY.

Joining the Express lineup in 2009 is the Express 4500. | This Heavy-Duty Commercial Cutaway model offers best-in-class payload^{1,2} of 9,050 lbs. | 14,200 lbs. standard GVWR.³ | Two engines are available: the gasoline-powered Vortec 6.0L V8 that offers best-in-class horsepower¹ and the Duramax 6.6L Turbo-Diesel V8 that offers best-in-class horsepower and torque.¹ | The powerful diesel comes with a 57-gallon rear fuel tank and transmission fluid cooler. | The body structure has been enhanced by a 10 percent increase on select components, such as sheet metal thickness. | The chassis, frame and rear axle have all seen enhancements made to accommodate vocational upfits across a range of applications, including ambulance, shuttle, school bus and recreational vehicles.

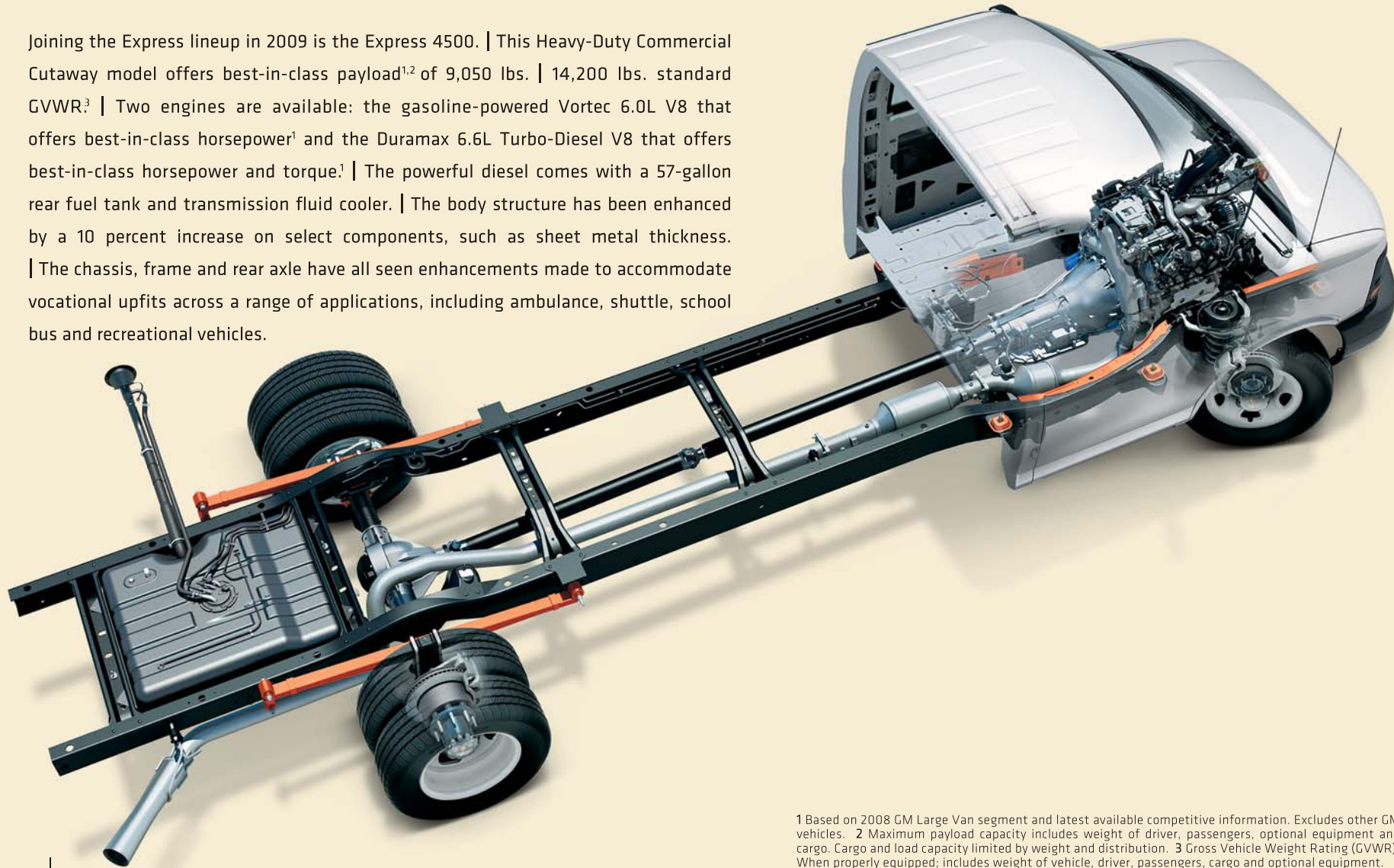

¹ Based on 2008 GM Large Van segment and latest available competitive information. Excludes other GM vehicles. ² Maximum payload capacity includes weight of driver, passengers, optional equipment and cargo. Cargo and load capacity limited by weight and distribution. ³ Gross Vehicle Weight Rating (GVWR). When properly equipped; includes weight of vehicle, driver, passengers, cargo and optional equipment.

CHEVY EXPRESS CUTAWAY.

Express Cutaway models offer you the option to create a vehicle that fits your exact needs. | The Express 3500 Commercial Cutaway is available in three wheelbases: **139-INCH, 159-INCH AND 177-INCH.** The Express 4500 Cutaway comes standard with a **159-INCH WHEELBASE.** | Each Cutaway model comes standard with Vortec V8 power and a Hydra-Matic HD four-speed automatic OD transmission. | The available **DURAMAX DIESEL IS THE MOST POWERFUL DIESEL IN ITS CLASS!** | The two axle ratios, available for both models, are 3.73 and 4.10. | Other standard equipment includes Oil-Life Monitor, four-wheel antilock brake system with Dynamic Rear Proportioning, power steering and air conditioning. | The van's strong, full-length, ladder-type frame is designed to work with the numerous upfits available from independent suppliers.

¹ Based on 2008 GM segmentation and latest available competitive information. Excludes other GM vehicles.

CHEVY EXPRESS COMMERCIAL CUTAWAY SELECT SPECIFICATIONS S = STANDARD O = OPTIONAL - = NOT AVAILABLE

ENGINE AVAILABILITY	HP @ RPM	TORQUE (LB.-FT.) @ RPM	139-IN. WHEELBASE (3500)	159-IN. WHEELBASE (3500)	177-IN. WHEELBASE (3500)	159-IN. WHEELBASE (4500)
Vortec 4.8L V8 ¹	279 @ 5200	294 @ 4500	S	-	-	-
Vortec 4.8L V8 ²	258 @ 4600	294 @ 4500	S	-	-	-
Vortec 6.0L V8	323 @ 4600	373 @ 4400	O	S	S	S
Duramax Diesel 6.6L V8	250 @ 3200	460 @ 1600	O ³	O	O	O ⁴
TRANSMISSION AVAILABILITY						
Hydra-Matic heavy-duty four-speed OD automatic with Tow/Haul mode			S	S	S	S
CHASSIS FEATURES						
Alternator: 145-amp			S	S	S	S
Battery: - 600-cca ⁵ - high-capacity, 770-cca ⁵			S O ⁶	S O ⁶	S O ⁶	S O ⁶
Brakes: - power hydraulic four-wheel ventilated disc - four-wheel antilock brake system (ABS) with Dynamic Rear Proportioning - front rotor diameter and thickness (in.) - rear rotor diameter and thickness (in.)			S S 12.8 x 1.5 12.8 x 1.8	S S 12.8 x 1.5 13.58 x 1.6	S S 12.8 x 1.5 13.58 x 1.6	S S 12.8 x 1.5 13.58 x 1.6
Differential: automatic locking rear			O	O	O	O
Oil-Life Monitor			S	S	S	S
Stabilizer bar: 35mm tubular front			S	S	S	S
Steering: power			S	S	S	S
Suspension, front: - independent with stabilizer bar and coil springs - axle capacity (lbs.)			S 4100/4600	S 4100/4600	S -/4600	S 4600
Suspension, rear: - hypoid drive axle with leaf springs - axle capacity (standard/optional GVWR, lbs.)			S 6084/8600	S 7500/8600	S 8600	S 9600

¹ On vehicles weighing less than 10,000 pounds. ² On vehicles weighing more than 10,000 pounds. ³ For 1WT trim levels. Includes 3.73 rear axle ratio, heavy-duty four-speed automatic transmission, external transmission oil cooler, dual 770-cca batteries and engine cooler. ⁴ For 2WT trim levels. Includes 4.10 rear axle ratio, heavy-duty four-speed automatic transmission, external transmission oil cooler and engine cooler. Included with Ambulance Package. ⁵ Cold-cranking amps. ⁶ Duramax Diesel comes with standard dual 770-cca batteries.

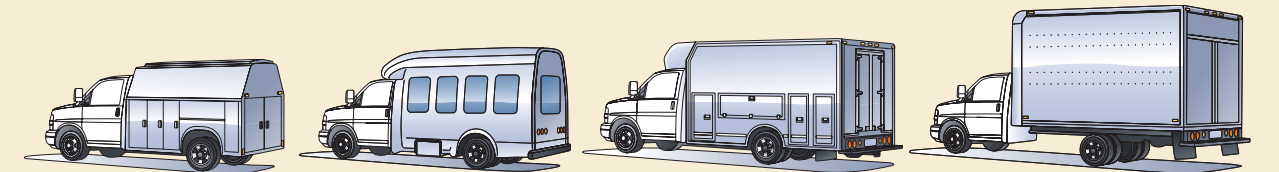

COMMERCIAL CUTAWAY CHASSIS APPLICATIONS offer a choice of three wheelbases, wide B-pillars and a full-length, ladder-type frame. Express Commercial Cutaway is a solid choice for accepting a variety of upfit bodies from an independent supplier. See back cover for more information about alterations and warranties.

BALL-HITCH TRAILERING

SILVERADO 1500 BALL HITCH TRAILERING

Weight-carrying hitch limit: 5,000-lb. trailer with 600-lb. tongue weight. Z85 Handling/Trailer Suspension or Z71 Off-Road Suspension (4x4 only) and a weight-distributing hitch with sway control required over 5,000-lb. trailer weight. Please read the Trailering Basics on page 33 before towing a trailer with any Chevy Truck.

VORTEC 4.3L V6	BOX LENGTH (FT.)	MAX. TRAILER WEIGHT¹ (LBS.)	REQUIRED AXLE RATIO	GCWR² (LBS.)
1500 2WD Regular Cab	6' 6"/8'	4800/4700	3.23	9500
1500 2WD Extended Cab	5' 8"/6' 6"	4400/4400	3.23	9500
1500 4x4 Regular Cab	6' 6"/8'	5100/4900	3.73	10,000
VORTEC 4.8L V8				
1500 2WD Regular Cab	6' 6"/8' 6' 6"/8"	5200/5100 7200/7100	3.23 3.73	10,000 12,000
1500 2WD Extended Cab	5' 8"/6' 6" 5' 8"/6' 6"	5800/4700 6800/6700	3.23/3.42 3.73	10,000/11,000 12,000
1500 2WD Crew Cab	5' 8" 5' 8"	4700 6700	3.23 3.73	10,000 12,000
1500 4x4 Regular Cab	6' 6"/8'	6000/5800	3.42	11,000
1500 4x4 Extended Cab	5' 8"/6' 6"	5500/5500	3.42	11,000
1500 4x4 Crew Cab	5' 8"	5400	3.42	11,000
VORTEC 5.3L V8				
1500 2WD Regular Cab	6' 6"/8' 6' 6"/8'	7200/7000 8200/8000	3.42 3.73	12,000 13,000
1500 2WD Regular Cab w/ 6-speed auto. trans. ^{3,4}	6' 6" 8'	9200 10,000	3.42 3.42	13,000 15,000
1500 2WD Extended Cab	5' 8" 5' 8" 6' 6" 6' 6"/8'	6800 7800 6700 7700/7600	3.42 3.73 3.42 3.73	12,000 13,000 12,000 13,000
1500 2WD Extended Cab w/ 6-speed auto. trans. ^{3,4}	6' 6"/8'	9700/9500	3.42	15,000
1500 2WD Crew Cab	5' 8" 5' 8"	6100 9600 ³	3.42 3.42	11,500 15,000
1500 4x4 Regular Cab	6' 6"/8' 6' 6"/8'	7900/7900 8900/8900	3.73 4.10	13,000 13,000
1500 4x4 Regular Cab w/ 6-speed auto. trans. ^{3,4}	6' 6" 8'	8900 9800	3.42 3.42	14,000 15,000
1500 4x4 Extended Cab	5' 8" 5' 8" 6' 6"/8' 6' 6"	7500 8500 7500/7600 8500	3.73 4.10 3.73 4.10	13,000 14,000 13,000 14,000
1500 4x4 Extended Cab w/ 6-speed auto. trans. ^{3,4}	6' 6"/8'	9400/9200	3.42	15,000
1500 4x4 Crew Cab	5' 8" 5' 8"	6000 9500 ³	3.42 3.42	11,500 15,000
VORTEC 6.0L V8				
1500 4x4 Extended Cab ³	5' 8"	9400	3.42	15,000
1500 2WD Extended Cab ³	6' 6"	9700	3.42	15,000

VORTEC 6.0L V8 (CONTINUED)	BOX LENGTH (FT.)	MAX. TRAILER WEIGHT¹ (LBS.)	REQUIRED AXLE RATIO	GCWR² (LBS.)
1500 2WD Extended Cab – MAX Trailering Pack	6' 6"	10,700	3.73	16,000
1500 4x4 Extended Cab ³	6' 6"	9400	3.42	15,000
1500 4x4 Extended Cab – MAX Trailering Pack	6' 6"	10,400	3.73	16,000
1500 2WD Crew Cab ³	5' 8"	9600	3.42	15,000
1500 2WD Crew Cab – MAX Trailering Pack	5' 8"	10,600	3.73	16,000
1500 4x4 Crew Cab ³	5' 8"	9300	3.42	15,000
1500 4x4 Crew Cab – MAX Trailering Pack	5' 8"	10,400	3.73	16,000
VORTEC 6.2L V8				
1500 Crew Cab 2WD – MAX Trailering Pack	5' 8"	10,600	3.73	16,000
1500 Crew Cab 2WD ³	5' 8"	9600	3.42	15,000
1500 Crew Cab 4x4 – MAX Trailering Pack	5' 8"	10,400	3.73	16,000
1500 Crew Cab 4x4 ³	5' 8"	9300	3.42	15,000

SILVERADO 2500HD AND 3500HD BALL HITCH TRAILERING

Weight-carrying hitch limit: 7,500-lb. trailer with 1,000-lb. tongue weight. Weight-distributing hitch with sway control required over 7,500-lb. trailer weight. Please read the Trailering Basics on page 33 before towing a trailer with any Chevy Truck.

VORTEC 6.0L V8	BOX LENGTH (FT.)	MAX. TRAILER WEIGHT¹ (LBS.)	REQUIRED AXLE RATIO	GCWR² (LBS.)
2500HD Regular Cab 2WD	8'	10,500 13,000	3.73 4.10	16,000 18,500
2500HD Regular Cab 4x4	8'	10,200 12,700	3.73 4.10	16,000 18,500
2500HD Extended Cab 2WD	6' 6"/8'	10,200/10,000 12,700/12,500	3.73 4.10	16,000 18,500
2500HD Extended Cab 4x4	6' 6"/8'	9900/9800 12,400/12,300	3.73 4.10	16,000 18,500
2500HD Crew Cab 2WD	6' 6"/8'	10,000/9900 12,500/12,400	3.73 4.10	16,000 18,500
2500HD Crew Cab 4x4	6' 6"/8'	9800/9600 12,300/12,100	3.73 4.10	16,000 18,500
3500HD SRW Regular Cab 4x4	8'	10,000 12,500	3.73 4.10	16,000 18,500
3500HD SRW Extended Cab 2WD	8'	9900 12,400	3.73 4.10	16,000 18,500
3500HD SRW Extended Cab 4x4	8'	9600 12,100	3.73 4.10	16,000 18,500
3500HD SRW Crew Cab 2WD	8'	9700 12,200	3.73 4.10	16,000 18,500
3500HD SRW Crew Cab 4x4	8'	9400 11,900	3.73 4.10	16,000 18,500
3500HD DRW Regular Cab 4x4	8'	9700 12,200	3.73 4.10	16,000 18,500
3500HD DRW Extended Cab 2WD	8'	9500 12,000	3.73 4.10	16,000 18,500
3500HD DRW Extended Cab 4x4	8'	9200 11,700	3.73 4.10	16,000 18,500

VORTEC 6.0L V8 (CONTINUED)	BOX LENGTH (FT.)	MAX. TRAILER WEIGHT¹ (LBS.)	REQUIRED AXLE RATIO	GCWR² (LBS.)
3500HD DRW Crew Cab 2WD	8'	9300 11,800	3.73 4.10	16,000 18,500
3500HD DRW Crew Cab 4x4	8'	9100 11,600	3.73 4.10	16,000 18,500
DURAMAX DIESEL 6.6L V8 TURBO				
2500HD Regular Cab 2WD	8'	13,000	3.73	22,000
2500HD Regular Cab 4x4	8'	13,000	3.73	22,000
2500HD Extended Cab 2WD	6' 6"/8'	13,000/13,000	3.73	22,000
2500HD Extended Cab 4x4	6' 6"/8'	13,000/13,000	3.73	22,000
2500HD Crew Cab 2WD	6' 6"/8'	13,000/13,000	3.73	22,000
2500HD Crew Cab 4x4	6' 6"/8'	13,000/13,000	3.73	22,000
3500HD SRW Regular Cab 4x4	8'	13,000	3.73	22,000
3500HD SRW Extended Cab 2WD	8'	13,000	3.73	22,000
3500HD SRW Extended Cab 4x4	8'	13,000	3.73	22,000
3500HD SRW Crew Cab 2WD	8'	13,000	3.73	22,000
3500HD SRW Crew Cab 4x4	8'	13,000	3.73	22,000
3500HD DRW Regular Cab 4x4	8'	13,000	3.73	23,500
3500HD DRW Extended Cab 2WD	8'	13,000	3.73	23,500
3500HD DRW Extended Cab 4x4	8'	13,000	3.73	23,500
3500HD DRW Crew Cab 2WD	8'	13,000	3.73	23,500
3500HD DRW Crew Cab 4x4	8'	13,000	3.73	23,500

SRW – Single rear wheel. DRW – Dual rear wheel. ¹ Maximum trailer weight ratings are calculated assuming a base vehicle, except for any option(s) necessary to achieve the rating, plus driver. The weight of other optional equipment, passengers and cargo will reduce the maximum trailer weight your vehicle can tow. See your Chevy dealer for additional details. ² Gross Combination Weight Rating. ³ With Heavy Duty Cooling Package. ⁴ Interim availability. NOTE: Trailer tongue weight should be 10 to 15 percent of total loaded trailer weight (up to 1,500 lbs. on 2500HD and 3500HD models). Trailer kingpin weight should be 15 to 25 percent of total loaded trailer weight (up to 3,000 lbs. on 2500HD and up to 3,500 lbs. on 3500HD models). [■] Addition of trailer tongue weight/trailer kingpin weight cannot cause vehicle weights to exceed Rear Gross Axle Weight Rating (RGAWR) or Gross Vehicle Weight Rating (GVWR). These ratings can be found on the certification label located on the driver door or doorframe.

CHEVY EXPRESS WORK VAN BALL-HITCH TRAILERING

Weight-carrying hitch limit: 4,000-lb. trailer with 400-lb. tongue weight. A weight-distributing hitch and sway control are required over 4,000-lb. trailer weight. Please read the Trailering Basics on page 33 before towing with any Chevy Truck.

VORTEC 4.3L V6	MAX. TRAILER WEIGHT¹ (LBS.)	REQUIRED AXLE RATIO	GCWR² (LBS.)
1500 Work Van RWD	4300	3.42	9500
VORTEC 4.8L V8			
2500HD Work Van	6300/7300	3.73/4.10	12,000/13,000
2500HD EXT Work Van	6100/7100	3.73/4.10	12,000/13,000
VORTEC 4.8L V8			
3500 Super Heavy Work Van	6200/7200	3.73/4.10	12,000/13,000
3500 EXT Super Heavy Work Van	6000/7000	3.73/4.10	12,000/13,000
VORTEC 5.3L V8			
1500 Work Van RWD	5900/5900	3.42/3.73	12,000
1500 Work Van AWD	6500/6500	3.42/3.73	12,000

VORTEC 6.0L V8	MAX. TRAILER WEIGHT¹ (LBS.)	REQUIRED AXLE RATIO	GCWR² (LBS.)
2500HD Work Van	8300/10,000	3.73/4.10	14,000/16,000
2500HD EXT Work Van	8100/10,000	3.73/4.10	14,000/16,000
3500 Super Heavy Work Van	8200/10,000	3.73/4.10	14,000/16,000
3500 EXT Super Heavy Work Van	8000/10,000	3.73/4.10	14,000/16,000
DURAMAX DIESEL 6.6L V8 (AUTOMATIC)			
2500HD Work Van	10,000	3.73	18,500
2500HD EXT Work Van	10,000	3.73	18,500
3500 Super Heavy Work Van	10,000	3.73	18,500
3500 EXT Super Heavy Work Van	10,000	3.73	18,500

CHEVY EXPRESS PASSENGER VAN BALL-HITCH TRAILERING

Weight-carrying hitch limit: 4,000-lb. trailer with 400-lb. tongue weight. A weight-distributing hitch and sway control are not required. Please read the Trailering Basics on page 33 before towing with any Chevy Truck.

VORTEC 5.3L V8 (GAS & FLEXFUEL) (AUTOMATIC)	MAX. TRAILER WEIGHT¹ (LBS.)	REQUIRED AXLE RATIO	GCWR² (LBS.)
1500 Passenger Van RWD	6300	3.73	12,000
1500 Passenger Van AWD	6100	3.73	12,000
VORTEC 6.0L V8 (AUTOMATIC)			
2500 Passenger Van	7800	3.73	14,000
3500 Passenger Van	7700	3.73	14,000
3500 EXT Passenger Van	7400	3.73	14,000

COLORADO BALL-HITCH TRAILERING

Weight-carrying hitch limit: 4,000-lb. trailer with 500-lb. tongue weight. A weight-distributing hitch and sway control are not required. Please read the Trailering Basics on page 33 before towing with any Chevy Truck.

VORTEC 2.9L I-4 (AUTOMATIC)	BOX LENGTH (FT.)	MAX. TRAILER WEIGHT¹ (LBS.)	REQUIRED AXLE RATIO	GCWR² (LBS.)
Regular Cab (2WD/4x4)	6'	3400/3100	3.73	7000
Extended Cab (2WD/4x4)	6'	3200/2900	3.73	7000
Crew Cab (2WD/4x4)	5'	3000/-	3.73	7000
VORTEC 2.9L I-4 (MANUAL)				
Regular Cab (2WD/4x4)	6'	2400/2100	3.73	6000
Extended Cab (2WD/4x4)	6'	2200/1900	3.73	6000
Crew Cab (2WD/4x4)	5'	2100/-	3.73	6000
VORTEC 3.7L I-5 (AUTOMATIC)				
Regular Cab (2WD/4x4)	6'	4000/4000	3.73	9000
Extended Cab (2WD/4x4)	6'	5500/5500	3.73	9500
Crew Cab (2WD/4x4)	5'	5500/5500	3.73	9800
VORTEC 5.3L V8 (AUTOMATIC)				
Extended Cab (2WD/4x4)	6'	6000/6000	3.73	10,400
Crew Cab (2WD/4x4)	5'	6000/6000	3.73	10,400

¹ Maximum trailer weight ratings are calculated assuming a base vehicle, except for any option(s) necessary to achieve the rating, plus driver. The weight of other optional equipment, passengers and cargo will reduce the maximum trailer weight your vehicle can tow. See your Chevy dealer for additional details. ² Gross Combination Weight Rating. **NOTE:** Trailer tongue weight should be 10 to 15 percent of total loaded trailer weight (up to 350 lbs.). [■] Addition of trailer tongue weight cannot cause vehicle weights to exceed Rear Gross Axle Weight Rating (RGAWR) or Gross Vehicle Weight Rating (GVWR). These ratings can be found on the certification label located on the driver door or doorframe.

FIFTH-WHEEL TRAILERING

SILVERADO 1500 FIFTH-WHEEL TRAILERING

Fifth-wheel trailering with a Silverado 1500 requires Z85 Handling/Trailering Suspension or Z71 Off-Road Package. Please read the Trailering Basics on page 33 before towing a trailer with any Chevy Truck.

VORTEC 4.8L V8	BOX LENGTH (FT.)	MAX. TRAILER WEIGHT ¹ (LBS.)	REQUIRED AXLE RATIO	GCWR ² (LBS.)
1500 2WD Regular Cab	6' 6"/8'	7200/7100	3.73	12,000
1500 2WD Extended Cab	6' 6"	6700	3.73	12,000
VORTEC 5.3L V8				
1500 2WD Regular Cab	6' 6"/8' 6' 6"/8'	7200/7000 8200/8000	3.42 3.73	12,000 13,000
1500 2WD Regular Cab w/ 6-speed auto. trans ^{3,4}	6' 6" 8'	9200 8700	3.42 3.42	13,000 15,000
1500 2WD Extended Cab	6' 6" 6' 6"/8'	6700 7700/7500	3.42 3.73	12,000 13,000
1500 2WD Extended Cab w/ 6-speed auto. trans ^{3,4}	6' 6"/8'	9100/8700	3.42	15,000
1500 4x4 Regular Cab	6' 6"/8' 6' 6"/8'	7900/7800 8300/8800	3.73 4.10	13,000 13,000
1500 4x4 Regular Cab w/ 6-speed auto. trans ^{3,4}	6' 6" 8'	8100 9500	3.42 3.42	14,000 15,000
1500 4x4 Extended Cab	6' 6"/8'	7500/7600	3.73	13,000
1500 4x4 Extended Cab w/ 6-speed auto. trans ^{3,4}	6' 6"/8'	8900/7700	3.42	15,000

VORTEC 6.0L V8

1500 2WD Extended Cab w/HD Cooling Package	6' 6"	8700	3.42	15,000
1500 2WD Extended Cab – MAX Trailering Pack	6' 6"	10,000	3.73	16,000
1500 4x4 Extended Cab w/HD Cooling Package	6' 6"	8400	3.42	12,000
1500 4x4 Extended Cab – MAX Trailering Pack	6' 6"	9700	3.73	16,000

SILVERADO 2500HD AND 3500HD FIFTH-WHEEL TRAILERING

Please read the Trailering Basics on page 33 before towing a trailer with any Chevy Truck.

VORTEC 6.0L V8	BOX LENGTH (FT.)	MAX. TRAILER WEIGHT ¹ (LBS.)	REQUIRED AXLE RATIO	GCWR ² (LBS.)
2500HD Regular Cab 2WD	8' 8'	10,500 13,000	3.73 4.10	16,000 18,500
2500HD Regular Cab 4x4	8' 8'	10,200 12,700	3.73 4.10	16,000 18,500
2500HD Extended Cab 2WD	6' 6"/8' 6' 6"/8'	10,200/10,000 12,700/12,500	3.73 4.10	16,000 18,500
2500HD Extended Cab 4x4	6' 6"/8' 6' 6"/8'	9900/9800 12,400/12,300	3.73 4.10	16,000 18,500
2500HD Crew Cab 2WD	6' 6"/8' 6' 6"/8'	10,000/9900 12,500/12,400	3.73 4.10	16,000 18,500
2500HD Crew Cab 4x4	6' 6"/8' 6' 6"/8'	9800/9600 12,300/12,100	3.73 4.10	16,000 18,500

VORTEC 6.0L V8 (CONTINUED)

	BOX LENGTH (FT.)	MAX. TRAILER WEIGHT ¹ (LBS.)	REQUIRED AXLE RATIO	GCWR ² (LBS.)
3500HD SRW Regular Cab 4x4	8' 8'	10,000 12,500	3.73 4.10	16,000 18,500
3500HD SRW Extended Cab 2WD	8' 8'	9900 12,400	3.73 4.10	16,000 18,500
3500HD SRW Extended Cab 4x4	8' 8'	9600 12,100	3.73 4.10	16,000 18,500
3500HD SRW Crew Cab 2WD	8' 8'	9700 12,200	3.73 4.10	16,000 18,500
3500HD SRW Crew Cab 4x4	8' 8'	9400 11,900	3.73 4.10	16,000 18,500
3500HD DRW Regular Cab 4x4	8' 8'	9700 12,200	3.73 4.10	16,000 18,500
3500HD DRW Extended Cab 2WD	8' 8'	9500 12,000	3.73 4.10	16,000 18,500
3500HD DRW Extended Cab 4x4	8' 8'	9200 11,700	3.73 4.10	16,000 18,500
3500HD DRW Crew Cab 2WD	8' 8'	9300 11,800	3.73 4.10	16,000 18,500
3500HD DRW Crew Cab 4x4	8' 8'	9100 11,600	3.73 4.10	16,000 18,500

DURAMAX DIESEL 6.6L V8 TURBO

2500HD Regular Cab 2WD	8'	15,800	3.73	22,000
2500HD Regular Cab 4x4	8'	15,500	3.73	22,000
2500HD Extended Cab 2WD	6' 6"/8'	15,500/15,300	3.73	22,000
2500HD Extended Cab 4x4	6' 6"/8'	14,500/13,800	3.73	22,000
2500HD Crew Cab 2WD	6' 6"/8'	15,300/14,500	3.73	22,000
2500HD Crew Cab 4x4	6' 6"/8'	13,900/12,700	3.73	22,000
3500HD SRW Regular Cab 4x4	8'	15,400	3.73	22,000
3500HD SRW Extended Cab 2WD	8'	15,400	3.73	22,000
3500HD SRW Extended Cab 4x4	8'	14,900	3.73	22,000
3500HD SRW Crew Cab 2WD	8'	15,000	3.73	22,000
3500HD SRW Crew Cab 4x4	8'	14,800	3.73	22,000
3500HD DRW Regular Cab 4x4	8'	16,500	3.73	23,500
3500HD DRW Extended Cab 2WD	8'	16,300	3.73	23,500
3500HD DRW Extended Cab 4x4	8'	16,100	3.73	23,500
3500HD DRW Crew Cab 2WD	8'	16,200	3.73	23,500
3500HD DRW Crew Cab 4x4	8'	15,900	3.73	23,500

SRW – Single rear wheel. DRW – Dual rear wheel. ¹ Maximum trailer weight ratings are calculated assuming a base vehicle, except for any option(s) necessary to achieve the rating, plus driver. The weight of other optional equipment, passengers and cargo will reduce the maximum trailer weight your vehicle can tow. See your Chevy dealer for additional details. ² Gross Combination Weight Rating. ³ With Heavy Duty Cooling Package. ⁴ Interim availability. NOTE: Trailer tongue weight should be 10 to 15 percent of total loaded trailer weight (up to 1,500 lbs. on 2500HD and 3500HD models). Trailer kingpin weight should be 15 to 25 percent of total loaded trailer weight (up to 3,000 lbs. on 2500HD and up to 3,500 lbs. on 3500HD models). [■] Addition of trailer tongue weight/trailer kingpin weight cannot cause vehicle weights to exceed Rear Gross Axle Weight Rating (RGAWR) or Gross Vehicle Weight Rating (GVWR). These ratings can be found on the certification label located on the driver door or doorframe. [■] Fifth-wheel hitch is available as a dealer-installed accessory on select models. See the Trailering Basics on page 33 for more trailering information.

CHASSIS CAB TRAILERING

COLORADO GROSS COMBINATION WEIGHT RATINGS

Please read the Trailering Basics at right before towing with any Chevy Truck.

VORTEC 2.9L I-4 (AUTOMATIC)	AXLE RATIO	GCWR ¹ (LBS.)
Regular Cab Chassis Cab (2WD and 4x4)	3.73	7000/6000
VORTEC 3.7L I-5 (AUTOMATIC)		
Regular Cab Chassis Cab	3.73	8500

SILVERADO GROSS COMBINATION WEIGHT RATINGS

Please read the Trailering Basics at right before towing with any Chevy Truck.

VORTEC 6.0L V8 (AUTOMATIC)	AXLE RATIO	GCWR ¹ (LBS.)
3500HD Regular Cab Short Wheelbase Chassis Cab (2WD and 4x4)	3.73 4.10	14,000 16,000
3500HD Regular Cab Long Wheelbase Chassis Cab (2WD and 4x4)	3.73 4.10	14,000 16,000
3500HD Extended Cab Chassis Cab (2WD and 4x4)	3.73 4.10	14,000 16,000
DURAMAX DIESEL 6.6L V8 (AUTOMATIC)		
3500HD Regular Cab Short Wheelbase Chassis Cab (2WD and 4x4)	3.73	23,500
3500HD Regular Cab Long Wheelbase Chassis Cab (2WD and 4x4)	3.73	23,500
3500HD Extended Cab Chassis Cab (2WD and 4x4)	3.73	23,500

KODIAK GROSS COMBINATION WEIGHT RATINGS

Please read the Trailering Basics at right before towing with any Chevy Truck.

VORTEC 8.1L MD V8 (AUTOMATIC)	AXLE RATIO RANGE ²	GCWR ¹ (LBS.)
2WD Regular Cab Chassis Cab	4.63–5.13	24,000–30,000
4x4 Regular Cab Chassis Cab	5.13	26,000
2WD Crew Cab Chassis Cab	4.63–5.13	24,000–30,000
4x4 Crew Cab Chassis Cab	5.13	26,000
2WD Chassis Cab Cutaway – Motorhome/Commercial	4.63–5.13	24,000–30,000

DURAMAX DIESEL 6.6L V8 (AUTOMATIC)

2WD Regular Cab Chassis Cab	4.30–4.88	24,000–30,000
4x4 Regular Cab Chassis Cab	5.13	26,000
2WD Crew Cab Chassis Cab	4.30–4.88	24,000–30,000
4x4 Crew Cab Chassis Cab	5.13	26,000
2WD Chassis Cab Cutaway – Motorhome/Commercial	4.30–4.88	24,000–30,000

¹ Gross Combination Weight Rating. ² Axle ratio availability limited by selected GCWR.

TRAILERING BASICS.

NOTE: Towing a trailer involves all major vehicle systems of your Chevy Truck. Easy and safe trailering requires a properly equipped vehicle, additional trailering equipment and an appropriate trailer. It also requires loading both the vehicle and trailer properly, using safe driving techniques, meeting regional legal requirements, and following break-in and maintenance schedules. The vehicle owner is responsible for obtaining the proper equipment (hitch ball, hitch type of the proper size, type and capacity) required to safely tow both the trailer and the load that will be towed. For more information, consult your Owner's Manual or speak to a trailering expert at your Chevrolet dealership. These charts will assist in determining how to best equip your Chevy Truck for trailering. To help you understand the charts, consider these trailering factors:

RGAWR AND GVWR: Addition of trailer hitch weight cannot cause vehicle weights to exceed Rear Gross Axle Weight Rating (RGAWR) or Gross Vehicle Weight Rating (GVWR). These ratings can be found on the certification label located on the driver door or doorframe.

GCWR: The Gross Combination Weight Rating is the total allowable weight of the completely loaded vehicle and trailer.

MAXIMUM TRAILER RATING: This rating is determined by subtracting the tow vehicle's weight (curb weight) from the GCWR. When a base vehicle (curb) weight is used, additional passenger, equipment and cargo weight reduces this rating.

NOTE: The safety steps described here are by no means the only precautions to be taken when trailering. See the Owner's Manual for your Chevy Silverado for additional guidelines and trailering tips.

TRAILERING CAUTION: If you don't use the correct equipment and drive properly, you can lose control of your vehicle when you pull a trailer. If the trailer is too heavy, your vehicle brakes may be less effective. You and your passengers could be seriously injured. Pull a trailer only after you have taken the following steps.

TRAILER BRAKES: If your trailer weighs more than 2,000 lbs. loaded, then it must have its own adequate brakes. Be sure to read and follow the instructions for the trailer brake controller so that it is installed, adjusted and maintained properly. [■] Don't tap into your vehicle's brake system if the trailer's brake system will use more than 0.02 cu. in. of fluid from your vehicle's master cylinder. If it does, neither braking system will work well. [■] The trailer brake parts must be able to take 3,000 psi of pressure. If everything checks out thus far, have a qualified individual make the brake fluid tap at the master cylinder port that sends fluid to the rear brakes. Use only double-walled steel brake tubing.

HITCHES: It's important to have the correct hitch equipment. [■] If you'll be towing a trailer that, when loaded, will weigh more than 5,000 lbs.!, be sure to use a frame-mounted, weight-distributing hitch and sway control of the proper size. [■] If you have to make any holes in the body of your vehicle to install a trailer hitch, be sure to seal the holes if you ever remove the hitch. If they're not sealed, dirt, water and deadly carbon monoxide from the exhaust can get into your vehicle.

FIFTH-WHEEL TRAILERING: Silverado pickups can be equipped with a fifth-wheel or gooseneck trailer hitch. [■] Follow the manufacturer's directions for installation, but note that the hitch must be attached to the truck frame. Do not use the pickup bed for additional support. For proper kingpin tongue load distribution and control of the trailer, the hitch must be mounted so the kingpin load is placed ahead of the rear axle centerline. [■] Fifth-wheel trailer kingpin loads are higher than conventional trailer tongue loads, so pay careful attention to the truck's payload capacity and rear axle weight ratings. [■] Your Chevy dealer can help you calculate the maximum allowable payload and GVWR required for your fifth-wheel trailering application. The weight of any additional equipment and all passengers other than the driver must be subtracted from the payload weight to determine the maximum kingpin load available.

¹ Maximum trailer rating may be less depending on powertrain combinations.

COMMERCIAL VEHICLE DIMENSIONS.

SILVERADO

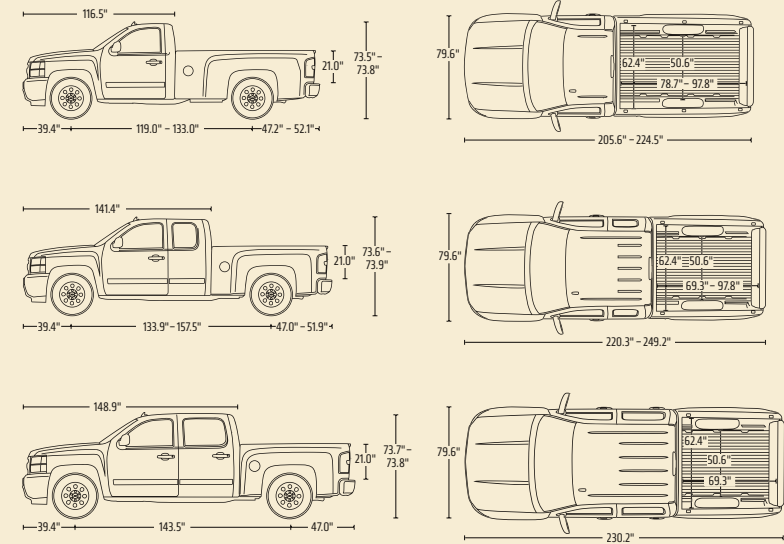

SILVERADO HD

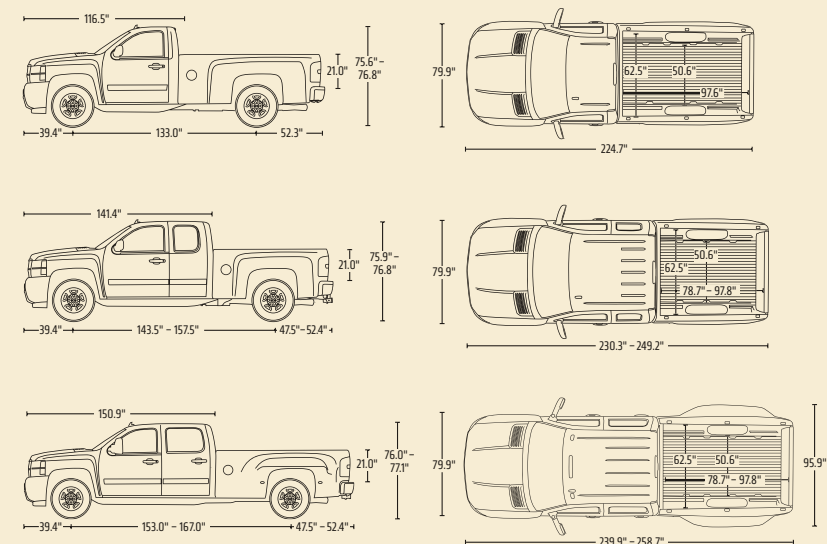

COLORADO

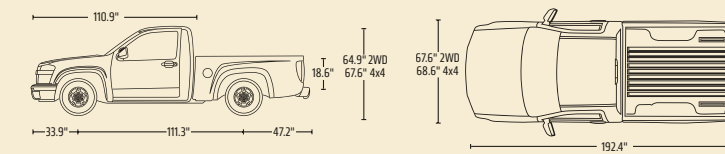

COLORADO CHASSIS CAB

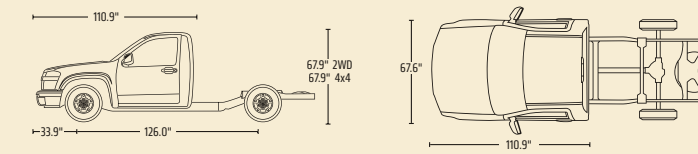

HHR

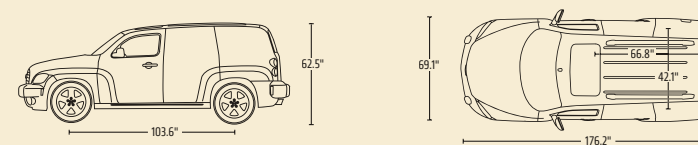

EXPRESS CARGO 135.0" Wheelbase/155.0" Wheelbase

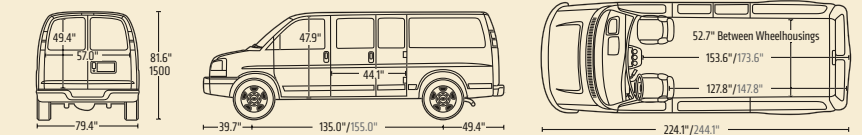

EXPRESS CHASSIS 139.0" Wheelbase/159.0" Wheelbase

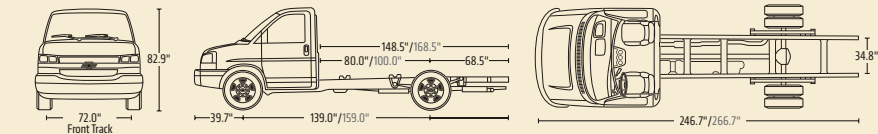

EXPRESS PASSENGER 135.0" Wheelbase/155.0" Wheelbase

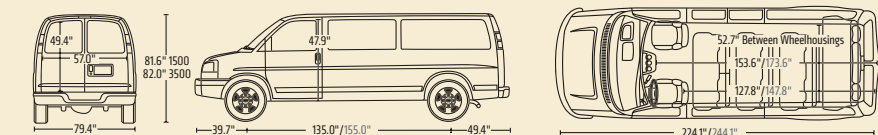

SILVERADO 3500HD CHASSIS CAB

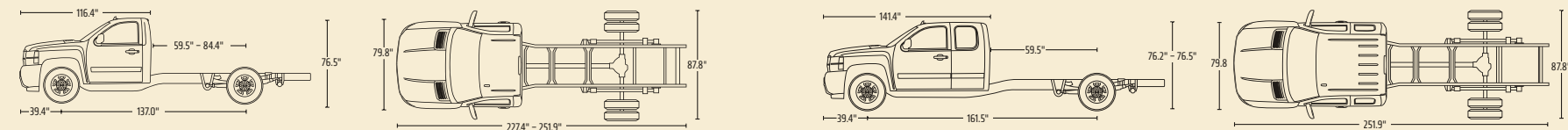

KODIAK

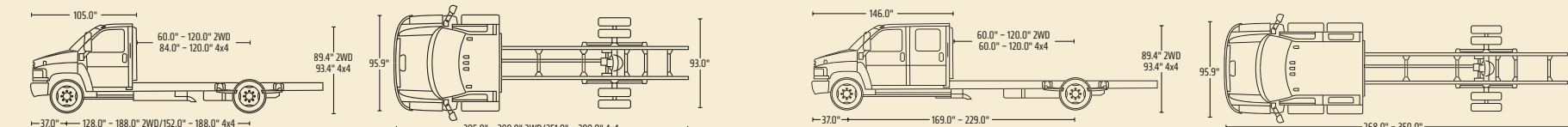

NOTE: For a complete list of all Commercial Vehicle dimensions and specifications, go to chevy.com.