

2018 IMPREZA



Impreza. More than a car, it's a Subaru.

 **SUBARU**
Confidence in Motion

“The improvements that have been made to this car are truly **outstanding**, cementing the Impreza as a real rival to the segment’s best.”

—AutoGuide.com, December 2016



It's your world. **Claim it.**

Ready to go all out, the 2018 Impreza is built to last, protect and get you where you want to go. The Impreza sedan and 5-door boast bold designs, advanced safety features and a drive that's fully connected, thanks to the SUBARU STARLINK™ Multimedia system with standard Apple CarPlay™ and Android™ Auto integration. Plus, with standard Subaru Symmetrical All-Wheel Drive and up to 38 highway MPG¹, you're free to go nearly anywhere you want. Impreza. More than a car, it's a Subaru.

1 EPA-estimated fuel economy for 2018 Impreza 2.0i sedan models with Lineartronic® CVT at 38 highway MPG. Excludes Sport models. Actual mileage may vary.

Impreza 2.0i Limited 5-door in Crimson Red Pearl and 2.0i Sport sedan in Magnetite Gray Metallic with optional equipment.



The Subaru Impreza was named 2017 **Best Resale Value** in its class by Kelley Blue Book's KBB.com.¹



© 2018 Impreza



Long-lasting

As the longest-lasting vehicle in its class,² the Impreza was built to inspire your trust. You can count on the Subaru Global Platform with an increased use of high-strength steel for better crash protection. You also have the famously reliable SUBARU BOXER[®] engine with standard Subaru Symmetrical All-Wheel Drive.



Safety-focused

The 2018 Impreza is available with the latest in safety tech. EyeSight[®] Driver Assist Technology,^{3,4} Blind-Spot Detection and Rear Cross-Traffic Alert^{3,5} are available to help you spot and avoid danger. There are also LED Steering Responsive Headlights (SRH) that turn with the steering wheel to help you see around corners.³ Finally, there's High Beam Assist that automatically dims and activates the high beams as needed, providing maximum visibility at all times.³



Fuel-efficient

Responsive power and exceptional fuel economy give you extra fun without added cost in the 2018 Impreza. It achieves up to 38 highway MPG⁶ with standard Subaru Symmetrical All-Wheel Drive, thanks to its reliable 152-hp SUBARU BOXER[®] engine with direct injection. Plus, it can go more than 450 miles on a full tank, making it that much easier to roam as you please.⁷



Well-connected

Take your favorite content almost anywhere you go. Impreza features the latest STARLINK[™] Multimedia system with standard Apple CarPlay[™] and Android[™] Auto integration.^{8,9} For added safety and help when you may need it most, STARLINK[™] Safety and Security includes Automatic Collision Notification, Stolen Vehicle Recovery and more.^{3,9}

¹ Vehicle's projected resale value is specific to the 2017 model year. For more information, visit www.kbb.com. Kelley Blue Book is a registered trademark of Kelley Blue Book Co., Inc. ² Based on the average of vehicles in operation vs. new registrations for each model year using IHS Markit data as of October 2016 for MY2007–2016. ³ Availability varies by trim level. See your retailer. ⁴ EyeSight is a driver assist technology, which may not operate optimally under all driving conditions. The driver is always responsible for safe and attentive driving. System effectiveness depends on many factors such as vehicle maintenance, weather and road conditions. See Owner's Manual for complete details on system operations and limitations. ⁵ Blind-Spot Detection, Lane Change Assist and Rear Cross-Traffic Alert are systems designed to assist the driver by monitoring the rear and side areas of the vehicle during a lane change or reversing and are not a substitute for safe and attentive driving. ⁶ EPA-estimated fuel economy for 2018 Impreza 2.0i sedan models with Lineartronic[®] CVT at 38 highway MPG. Excludes Sport models. Actual mileage may vary. ⁷ Driving range based on a 13.2-gallon fuel tank capacity and EPA-estimated highway fuel economy for 2018 Subaru Impreza models equipped with Lineartronic[®] CVT. Actual driving range may vary. ⁸ Compatible smartphone and applications required. For applications to operate, latest version of each application is required. Data provided by smartphone is displayed on the audio system screen. Some state laws prohibit the operation of handheld electronic devices while operating a vehicle. Smartphone apps should only be launched when vehicle is safely parked. Your wireless carrier's rates may apply. ⁹ Activation and required subscription sold separately. Includes 1-year Safety Plus trial subscription. See your retailer for details.

Impreza 2.0i Limited sedan in Ice Silver Metallic with optional equipment.



Hi-Tech Cabin

Come on in and play. The 2018 Impreza features the latest STARLINK™ Multimedia system with standard Apple CarPlay,¹ Android™ Auto and Pandora® integration.¹ Wireless pairing and hands-free smartphone operation allow for safe and easy access to news, music, podcasts, and more through available STARLINK™ apps like iHeartRadio® and Stitcher,² and SiriusXM® All Access Radio.^{2,3} It can also read and display your incoming texts, allowing you to keep your eyes on the road.^{3,4} Plus, a voice-activated navigation system powered by TomTom® is available with a large 8-inch touchscreen.³

You can hear every note of your favorite tunes with the available 8-speaker 432-watt-equivalent Harman Kardon® premium audio system.³ There's also Keyless Access with Push-Button Start³ that not only makes getting on your way a breeze, it even smartly prevents you from locking your keys in your car.

1 Compatible smartphone and applications required. For applications to operate, latest version of each application is required. Data provided by smartphone is displayed on the audio system screen. Some state laws prohibit the operation of handheld electronic devices while operating a vehicle. Smartphone apps should only be launched when vehicle is safely parked. Your wireless carrier's rates may apply. 2 Activation and required monthly subscription sold separately. Includes 4-month trial subscription. See your retailer. 3 Availability varies by trim level. See your retailer. 4 STARLINK can read incoming texts out loud when the vehicle is traveling at speeds over 5 miles per hour, and can display incoming texts on screen when the vehicle is traveling at speeds lower than 5 miles per hour.

No other car in its class has more passenger volume than the Subaru Impreza.¹

—IHS Markit

Room to push limits.

Invite possibilities, not excuses, in the spacious 2018 Impreza. Enjoy up to 99.8² cubic feet of passenger space in the sedan and up to 100.9² cubic feet in the 5-door. Both body styles include large cargo areas, and the 5-door provides a wide rear gate opening for added convenience. Plus, you can adjust the 60/40-split flat-folding rear seatbacks in an instant to accommodate longer items and a rear passenger on the same trip. Designed for comfort, the Impreza also includes available features like a 6-way power driver's seat and heated front seats. Its leather-trimmed steering wheel, shift knob and seats help make the cabin extra welcoming, and you can count on just the right temperature, thanks to available automatic climate control.³

¹ Based on passenger volume information from OEM websites, Edmunds.com, and the EPA for 2016 model vehicles within the Non-Luxury Traditional Compact segment only among non-hybrid vehicles. Segment definition supplied by IHS Markit. ² Without available power moonroof. ³ Availability varies by trim level. See your retailer.



A 2017 IIHS Top Safety Pick+ with EyeSight® and Steering Responsive Headlights.

An extra set of eyes **every time you drive.**

Pre-Collision Braking

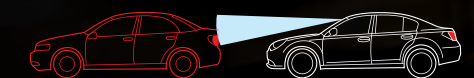

A driver ahead unexpectedly hits the brakes or cuts you off. EyeSight®¹ warns you, applies the brakes and, at lower speeds, can even help you stop your Subaru.

Adaptive Cruise Control



Traffic doesn't always flow smoothly, so EyeSight® doesn't only keep a set speed. The system looks ahead and helps automatically adjust to keep your distance, even in stop-and-go highway traffic.

Pre-Collision Throttle Management



If you put the car in Drive instead of Reverse and EyeSight® sees an object in your path, it cuts power to help you avoid accelerating into it.

Lane Departure and Sway Warning with Lane Keep Assist

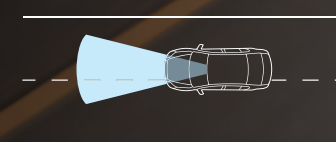

You accidentally drift to the edge of your lane and begin to cross into another. EyeSight® watches for lane markers and chimes to warn you before you leave your lane, and it can even help steer you back into your proper course, thanks to Lane Keep Assist.



© 2018 Impreza

¹ EyeSight is a driver assist technology, which may not operate optimally under all driving conditions. The driver is always responsible for safe and attentive driving. System effectiveness depends on many factors such as vehicle maintenance, weather and road conditions. See Owner's Manual for complete details on system operation and limitations.

Thinking ahead. **Even before you do.**

Enhanced Safety

Ready for what may come, the 2018 Impreza offers extra awareness with a standard Rear-Vision Camera, reliable protection with a rigid Ring-shaped Reinforcement Frame, and the reassurance of seven standard airbags.¹ Available safety features include Reverse Automatic Braking^{2,3} as well as LED Steering Responsive Headlights that turn with the steering wheel to help you see around corners more easily.³ Plus, High Beam Assist can automatically dim and activate the high beams as needed, providing maximum visibility at all times.³

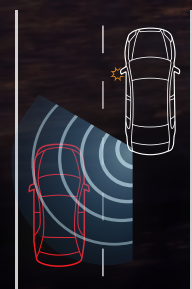

Blind-Spot Detection

Using radar sensors, the Blind-Spot Detection system warns you with a visual indicator in your side mirror if it senses a vehicle in your blind spot. Another feature of this system, Lane Change Assist, alerts you with a flashing indicator in your side mirror if it senses a vehicle approaching at a higher speed in a neighboring lane and you signal for a lane change.^{3,4}

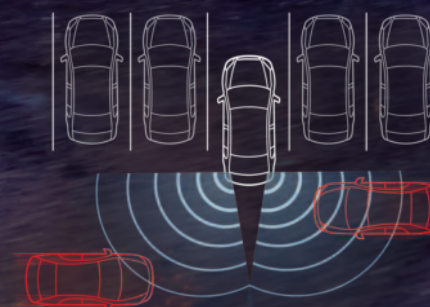

Rear Cross-Traffic Alert

Rear Cross-Traffic Alert uses radar sensors to help warn you of traffic approaching from the side as you are backing up, utilizing a flashing visual indicator in your side mirror and an audible warning.^{3,4}

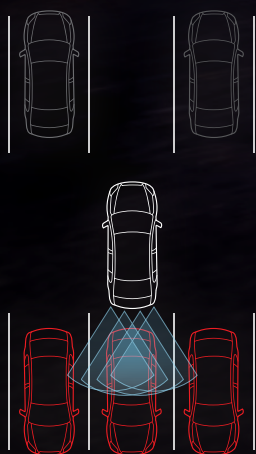

Reverse Automatic Braking

Reverse Automatic Braking^{2,3} can detect objects directly behind your vehicle when backing up at a low speed and can help bring the Impreza to a stop should an object be detected within its range and the driver fail to act. There's also a Rear-Vision Camera to help you keep an eye out.



SUBARU STARLINK™ Safety and Security

Providing extra peace of mind, STARLINK™ Safety and Security gives you instant access to help when you need it most. With Automatic Collision Notification to send first responders when an airbag deploys, Stolen Vehicle Recovery to help police locate your vehicle if it's stolen and more, STARLINK™ Safety and Security helps keep you and your Subaru safe.^{3,5}

1 Always wear seatbelts. Children should be properly restrained in the rear seat. 2 Requires EyeSight. The Reverse Automatic Braking System is not a substitute for safe and attentive driving. System effectiveness depends on many factors, such as vehicle maintenance, weather and road conditions. Always exercise caution and use vehicle mirrors and the Rear-Vision Camera when backing up. See Owner's Manual for complete details on system operation and limitations. 3 Availability varies by trim level. See your retailer. 4 Blind-Spot Detection, Lane Change Assist and Rear Cross-Traffic Alert are systems designed to assist the driver by monitoring the rear and side areas of the vehicle during a lane change or reversing and are not a substitute for safe and attentive driving. 5 Activation and required subscription sold separately. Includes 1-year Safety Plus trial subscription. See your retailer for details.

The Subaru Impreza is the **longest-lasting vehicle** in its class!¹

IHS Markit



“... an **incredibly compelling choice** in the incredibly competitive compact car segment.”

CNET.com, December 2016



Subaru is Kelley Blue Book's **2017 Most Trusted Brand, Best Overall Brand, and Lowest 5-Year Cost to Own.**²



“Where the Impreza really **starts to feel like an Audi** is in the corners.”

CarandDriver.com, December 2016



The Subaru Impreza **retains its value better than any other vehicle in its class** for 2017, according to ALG.³



One of Kelley Blue Book's **10 Coolest Cars Under \$18,000** for 2017.⁴



2018 Impreza | Trim Levels



2.0i sedan and 5-door

- 152-hp 2.0-liter 4-cylinder SUBARU BOXER® engine with direct injection
- Subaru Symmetrical All-Wheel Drive
- 5-speed manual transmission or optional Lineartronic® CVT (Continuously Variable Transmission)
- 16-inch steel wheels with covers
- Cloth upholstery
- Black simulated carbon fiber interior accent trim
- 6-way manually adjustable driver's seat and 4-way manually adjustable front-passenger's seat
- Auto-up/down driver's and front-passenger's power windows
- SUBARU STARLINK™ 6.5-inch Multimedia with Apple CarPlay™, Android™ Auto, Pandora® and Aha™ smartphone app integration⁵, high-resolution LCD touchscreen display, 4 speakers, AM/FM stereo, USB port/iPod® control, Bluetooth® audio streaming and hands-free phone connectivity, and 3.5-mm auxiliary jack
- Manually adjustable CFC-free air conditioning with air filtration
- Electronic cruise control
- Rear-View Camera



2.0i Premium sedan and 5-door

Includes 2.0i key features and adds:

- Lineartronic® CVT (Continuously Variable Transmission) with 7-speed manual-mode and paddle shifters
- 16-inch alloy wheels
- Roof rails in silver finish (5-door)
- Body-color side mirrors
- 6 speakers
- STARLINK™ Safety Plus enabled⁶: Automatic Collision Notification, SOS Emergency Assistance, Enhanced Roadside Assistance, Maintenance Notifications, Monthly Vehicle Health Report, Diagnostic Alerts
- All-Weather Package: Heated exterior mirrors, dual-mode heated front seats, windshield wiper de-icer
- Auto-on/off headlights
- Welcome lighting
- Cargo area cover (5-door)



2.0i Sport sedan and 5-door⁷

Includes 2.0i Premium key features and adds:

- 5-speed manual transmission with short-throw shifter or optional Lineartronic® CVT (Continuously Variable Transmission)
- Active Torque Vectoring
- Sport-tuned suspension
- 18-inch alloy wheels
- Body-color door mirrors with integrated turn signals
- Trunk spoiler (sedan)
- Body-color side rocker spoilers
- LED Daytime Running Lights
- Active grille shutter
- Sport cloth interior with red stitching
- Leather-wrapped steering wheel and shifter handle with red stitching
- Gray simulated carbon fiber interior accent trim
- SUBARU STARLINK™ 8.0-inch Multimedia Plus with Apple CarPlay™, Android™ Auto, Pandora® and Aha™ smartphone app integration⁵, STARLINK™ cloud-based applications, including Yelp®, iHeartRadio®, Magellan® navigation⁸, SiriusXM® All Access Radio⁹ and Travel Link⁹, high-resolution LCD touchscreen display, 6 speakers, AM/FM/CD player, HD Radio®, USB port/iPod® control, Bluetooth® audio streaming and hands-free phone and text messaging connectivity, and 3.5-mm auxiliary jack
- Keyless Access with Push-Button Start and PIN-code vehicle access
- Sport instrument cluster with color LCD display
- 6.3-inch color multifunction display



2.0i Limited sedan and 5-door

Includes 2.0i Premium key features and adds:

- 17-inch alloy wheels
- LED Steering Responsive Headlights (SRH)
- Fog lights
- Body-color side mirrors with integrated turn signals
- Active grille shutter
- 6-way power adjustable driver's seat
- Leather-trimmed upholstery
- Leather-wrapped steering wheel and shifter handle with silver stitching
- Shifter handle with leather boot and gloss black trim
- Gloss simulated carbon fiber and silver interior accent trim
- Keyless Access with Push-Button Start and PIN-code vehicle access
- SUBARU STARLINK™ 8.0-inch Multimedia Plus with Apple CarPlay™, Android™ Auto, Pandora® and Aha™ smartphone app integration⁵, STARLINK™ cloud-based applications, including Yelp®, iHeartRadio®, Magellan® navigation⁸, SiriusXM® All Access Radio⁹ and Travel Link⁹, high-resolution LCD touchscreen display, 6 speakers, AM/FM/CD player, HD Radio®, USB port/iPod® control, Bluetooth® audio streaming and hands-free phone and text messaging connectivity, and 3.5-mm auxiliary jack
- 6.3-inch color multifunction display
- High-grade instrument cluster with color LCD display
- Automatic climate control system with air filtration

¹ Based on the average of vehicles in operation vs. new registrations for each model year using IHS Markit data as of October 2016 for MY2007–2016. ² 2017 Kelley Blue Book Brand Image Awards are based on the Brand Watch™ study from Kelley Blue Book Strategic Insights. Award calculated among non-luxury shoppers. 2017 model-year vehicle's projected cost to own for the initial five-year ownership period is based on the average Kelley Blue Book 5-Year Cost to Own data which considers depreciation and costs such as fuel and insurance. For more information, visit www.kbb.com. Kelley Blue Book is a registered trademark of Kelley Blue Book Co., Inc. ³ ALG is the industry benchmark for residual values and depreciation data (www.alg.com). ⁴ For more information, visit www.kbb.com. Kelley Blue Book is a registered trademark of Kelley Blue Book Co., Inc. ⁵ Compatible smartphone and applications required. For applications to operate, latest version of each application is required. Data provided by smartphone is displayed on the audio system screen. Some state laws prohibit the operation of handheld electronic devices while operating a vehicle. Smartphone apps should only be launched when vehicle is safely parked. Your wireless carrier's rates may apply. ⁶ Activation and required subscription sold separately. Includes 1-year trial subscription. See your retailer for details. ⁷ Roof rails not available on 2.0i Sport 5-door models. ⁸ Activation and subscription required. See your retailer for details. ⁹ Activation and required monthly subscription sold separately. Includes 4-month trial subscription. See your retailer.

2018 Impreza | Specifications

Engine and Drivetrain		2.0i	2.0i Sport
Power Torque	2.0-liter DOHC direct injection aluminum-alloy 16-valve horizontally opposed 4-cylinder SUBARU BOXER® engine with Dual Active Valve Control System (DAVCS). 152 hp @ 6,000 rpm 145 lb-ft @ 4,000 rpm	●	●
Transmission	Fully synchronized 5-speed manual with Incline Start Assist. 2.0i and 2.0i Sport: Standard. 2.0i Premium and 2.0i Limited: N/A. Lineartronic® CVT (Continuously Variable Transmission) with Adaptive Control and Incline Start Assist. 2.0i and 2.0i Sport: Optional. 2.0i Premium and 2.0i Limited: Standard.	●	●
CA Emissions	LEV III / SULEV30	●	●
Traction and Stability		2.0i	2.0i Sport
All-Wheel Drive type	Subaru Symmetrical All-Wheel Drive	●	●
Vehicle Dynamics Control (VDC)	VDC electronic stability control utilizes sensors that constantly monitor wheel speeds, steering angle, brake pressure, vehicle yaw rate and lateral g-forces. If VDC detects a difference between the driver's intended path and the one the vehicle is actually taking, VDC applies braking power and/or reduces engine torque to help correct vehicle path.	●	●
Traction Control System (TCS)	VDC also incorporates an all-wheel, all-speed traction control system that senses a loss of traction and applies braking force to the slipping wheel or wheels as necessary to maintain vehicle motion.	●	●
Active Torque Vectoring	Active Torque Vectoring works in tandem with VDC, applying braking power to the inside front wheel, resulting in better handling, sharper turn-in, more neutral steering and higher cornering limit while turning.	—	●
Fuel		2.0i	2.0i Sport
Economy	Manual transmission: city/highway/combined ¹ Lineartronic® CVT: city/highway/combined ¹	Sedan: 24/32/27 mpg 5-door: 24/31/26 mpg	Sedan: 23/31/26 mpg 5-door: 22/30/25 mpg
Fuel Requirement	Unleaded gasoline (87 octane)	●	●
Fuel Capacity	13.2 gallons	●	●
Chassis		2.0i	2.0i Sport
Steering	Electric power-assisted quick ratio rack-and-pinion steering (EPAS). Turning circle: 35.4 feet	●	●

2018 Impreza | Specifications

Chassis (continued)		2.0i	2.0i Sport
Suspension	4-wheel independent. Front: MacPherson strut type. Stabilizer bar. Rear: Double-wishbone with lateral link pillow-ball joint bushing. Stabilizer bar. (2.0i: Front stabilizer bar only, 2.0i Sport: Sport-tuned)	●	●
Brakes	4-wheel disc, ventilated front. 4-channel, 4-sensor ABS with Electronic Brake-force Distribution (EBD).	●	●
Brake Discs (front/rear)	2.0i, 2.0i Premium, 2.0i Limited: 10.9 inches/10.8 inches 2.0i Sport: 11.6 inches/10.8 inches	●	●
Brake Assist	When emergency braking is detected by how quickly the brake pedal is pressed, maximum brake pressure is immediately applied.	●	●
Brake Override System	If both brake and accelerator pedals are pressed simultaneously, the system reduces the operation of the accelerator pedal to help prevent unintentional vehicle acceleration.	●	●
Wheels and Tires		2.0i	2.0i Sport
Wheels	2.0i: 16 x 6.5-inch steel with covers. 2.0i Premium: 16 x 6.5-inch aluminum-alloy. Silver finish. 2.0i Limited: 17 x 7.0-inch aluminum-alloy. Dark gray with machine finish. 2.0i Sport: 18 x 7.5-inch aluminum-alloy. Black with machine finish.	●	—
Tires	2.0i and 2.0i Premium: 205/55 R16 89V all-season 2.0i Sport: 225/40 R18 88V all-season 2.0i Limited: 205/50 R17 89V all-season	●	—
Spare Tire	Temporary use T135/80 D16	●	●

● Standard ○ Optional — Not equipped

Some images shown are for illustration purposes only. Specifications in this brochure are based on the latest product information available at the time of publication. For the most up-to-date and detailed product information, log on to www.subaru.com. Some equipment shown in photography in this brochure is optional at extra cost. Specific options may be available only in combination with other options. Specific combinations of equipment or features may vary from time to time and by geographic area. Certain accessories and equipment may not be available at the time of publication. Subaru of America, Inc., reserves the right to change or discontinue at any time, without notice, prices, colors, materials, equipment, accessories, specifications, models and packages without incurring any obligation to make the same or similar changes on vehicles previously sold. Colors shown may vary due to reproduction and printing processes.

This brochure was prepared by Subaru of America, Inc. A warranty from Subaru of America, Inc., is available only on cars sold to the first retail purchaser through an authorized Subaru retailer in the continental U.S. or Alaska. Every owner of the car during the warranty period shall be entitled to the benefit of these warranties. Subaru, SUBARU BOXER, Lineartronic, EyeSight and Impreza are registered trademarks of SUBARU CORPORATION. Confidence in Motion and STARLINK are trademarks of SUBARU CORPORATION. Added Security is a registered trademark of Subaru of America, Inc. Aha™ is a trademark of Harman International Industries, Inc. Android™ Auto is a trademark of Google Inc. Apple®, iPhone®, iPod® and iTunes® are registered trademarks of Apple Inc. Apple CarPlay™ is a trademark of Apple Inc. Bluetooth® is a registered trademark of Bluetooth SIG, Inc. Harman Kardon® is a registered trademark of Harman International Industries, Inc. HD Radio® is a registered trademark of iBiquity Digital Corporation. HomeLink® and the HomeLink house icon are registered trademarks of Gentex Corporation. SiriusXM®, Traffic® and Travel Link® are registered trademarks of SiriusXM Radio Inc. iHeartRadio® is a registered trademark of Clear Channel Communications, Inc. Magellan® is a registered trademark of MITAC International Corporation. Pandora® is a registered trademark of Pandora Media, Inc. Rockford Fosgate® is a registered trademark of Rockford Corporation. Thule® is a registered trademark of the Thule Group. TomTom® is a registered trademark of TomTom International BV. Yelp® is a registered trademark of Yelp Inc. For more information, contact your Subaru retailer or log on to www.subaru.com.

2018 Impreza | Equipment

Exterior	2.0i	2.0i Premium	2.0i Sport	2.0i Limited
LED Steering Responsive Headlights (SRH)	—	—	—	●
Fog lights	□	□	—	●
Heated side mirrors and windshield wiper de-icer (All-Weather Package)	—	●	●	●
Trunk spoiler (sedan)	—	—	●	—
Body-color side rocker spoilers	—	—	●	—
Power tilt/sliding-glass moonroof	—	○	○	○
Single exhaust outlet with stainless tip (sedan)	—	—	●	●
Raised roof rails in silver finish (5-door)	—	●	—	●
Roof cross bar fixed mounting points (models without roof rails)	●	●	●	●

Seating and Trim

6-way manually adjustable driver's seat. 4-way manually adjustable front-passenger's seat.	●	●	●	—
6-way power adjustable driver's seat. 4-way manually adjustable front-passenger's seat.	—	—	—	●
Heated front seats (All-Weather Package)	—	●	●	●
60/40-split flat-folding rear seatbacks	●	●	●	●
Leather-wrapped steering wheel with silver stitching	—	—	—	●
Leather-wrapped steering wheel with red stitching	—	—	●	—
Leather-wrapped automatic transmission shifter handle	—	—	○	●
Cloth upholstery	●	●	—	—
Sport cloth upholstery	—	—	●	—
Leather-trimmed upholstery	—	—	—	●
Aluminum-alloy pedal covers	—	—	●	—

Convenience Features

Keyless Access with Push-Button Start and PIN-code vehicle access	—	—	●	●
Welcome lighting (when approaching or departing vehicle)	—	●	●	●
One-touch lane change feature	●	●	●	●
Auto-on/off headlights	—	●	●	●
Auto-up/down driver's and front-passenger's power windows	●	●	●	●
Electronic cruise control	●	●	●	●
3-spoke steering wheel with integrated audio system, Bluetooth® and cruise control buttons	●	●	●	●
Automatic transmission manual-mode paddle shifters	—	●	○	●
Manually adjustable tilt/telescoping steering column	●	●	●	●
Cargo area cover (5-door)	—	●	●	●

Audio System

SUBARU STARLINK™ 6.5-inch Multimedia with Apple CarPlay™, Android™ Auto, Pandora® and Aha™ smartphone app integration², high-resolution LCD touchscreen, AM/FM stereo, USB port/iPod® control, Bluetooth® audio streaming and hands-free phone connectivity, and 3.5-mm auxiliary jack	●	●	—	—
SUBARU STARLINK™ 8.0-inch Multimedia Plus with Apple CarPlay™, Android™ Auto, Pandora® and Aha™ smartphone app integration², STARLINK™ cloud-based applications, including Yelp®, iHeartRadio®, Magellan® navigation³, SiriusXM® All Access Radio⁴ and Travel Link®⁴, high-resolution LCD touchscreen, AM/FM/CD player, HD Radio®, dual USB port/iPod® control, Bluetooth® audio streaming and hands-free phone and text messaging connectivity, and 3.5-mm auxiliary jack	—	—	●	●
4 speakers	●	—	—	—
6 speakers	—	●	●	●

Climate Control

Manually adjustable CFC-free air conditioning system with air filtration	●	●	●	—
Automatic climate control system with CFC-free air conditioning and air filtration	—	—	—	●

Instrumentation

Instrument cluster with analog speedometer, tachometer and "eco" fuel economy gauges, and 2.4-inch LCD display	●	●	—	—
Instrument cluster with analog speedometer and tachometer gauges, and 4.2-inch color LCD display	—	—	●	●

2018 Impreza | Equipment

Instrumentation (continued)

	2.0i	2.0i Premium	2.0i Sport	2.0i Limited
Multifunction display with digital trip computer, displaying current and average fuel economy, distance to empty, average vehicle speed, digital clock and ambient temperature	●	●	—	—
6.3-inch color multifunction display with information displays for fuel economy (average, current and distance to empty), heating and air conditioning (Limited models only), audio, weather, vehicle systems operation and more	—	—	●	●

Security

Keyless entry system with answer-back electronic chirp	●	●	●	●
Antitheft security system with engine immobilizer	●	●	●	●

Safety

ACTIVE				
Subaru Symmetrical All-Wheel Drive (AWD)	●	●	●	●
EyeSight® Driver Assist Technology ^{5,6}	—	○	○	○
Blind-Spot Detection with Lane Change Assist and Rear Cross-Traffic Alert ^{5,7}	—	○	○	○
Reverse Automatic Braking (RAB) ^{5,8}	—	—	—	○
Rear-Vision Camera	●	●	●	●
Tire Pressure Monitoring System (TPMS)	●	●	●	●
Daytime Running Lights (DRL)	●	●	●	●
PASSIVE				
STARLINK™ Safety Plus enabled ⁹ : Automatic Collision Notification, SOS Emergency Assistance, Enhanced Roadside Assistance, Maintenance Notifications, Monthly Vehicle Health Report, Diagnostic Alerts	—	●	●	●
Subaru advanced frontal airbag system with driver's and front-passenger's airbags (SRS) ¹⁰	●	●	●	●
Seat-mounted front side-impact airbags (SRS) ¹⁰	●	●	●	●
Side-curtain airbags protecting front and rear outboard occupants (SRS) ¹⁰	●	●	●	●
Driver's knee airbag (SRS) ¹⁰	●	●	●	●
Rollover sensor (SRS) ¹⁰	●	●	●	●
Whiplash-protection front seats with height-adjustable head restraints	●	●	●	●
Three individual rear-seat head restraints	●	●	●	●
Height-adjustable 3-point front seatbelts with dual pretensioners and force limiters. 3-point seatbelts at all rear seating positions.	●	●	●	●
LATCH system: Lower Anchors and Tethers for CHildren	●	●	●	●

Optional Equipment

STARLINK™ Safety Plus and Security Plus ³	—	○	○	○
Lineartronic® CVT (Continuously Variable Transmission)	○	●	○	●
Power moonroof	—	○	—	—
EyeSight ^{9,6} • Blind-Spot Detection with Rear Cross-Traffic Alert ⁷ • Steering Responsive Fog Lights (SRF)	—	○	—	—
EyeSight ^{9,6} • Blind-Spot Detection with Rear Cross-Traffic Alert ⁷ • Steering Responsive Fog Lights (SRF) • Power moonroof	—	○	—	—
Harman Kardon® audio system • Blind-Spot Detection with Rear Cross-Traffic Alert ⁷ • Power moonroof	—	—	○	—
Harman Kardon® audio system • EyeSight ^{9,6} • Blind-Spot Detection with Rear Cross-Traffic Alert ⁷ • Power moonroof	—	—	○ ¹¹	—
EyeSight ^{9,6} • Blind-Spot Detection with Rear Cross-Traffic Alert ⁷ • Reverse Automatic Braking (RAB) ⁸ • Power moonroof	—	—	—	○
SUBARU STARLINK™ 8.0-inch Multimedia Navigation • Harman Kardon® audio system • EyeSight ^{9,6} • Blind-Spot Detection with Rear Cross-Traffic Alert ⁷ • Reverse Automatic Braking (RAB) ⁸ • Power moonroof	—	—	—	○

EQUIPMENT CONTENTS

SUBARU STARLINK™ 8.0-inch Multimedia Navigation System: Voice-activated 8.0-inch multi-touch-gesture high-resolution GPS navigation system with Apple CarPlay™, Android™ Auto, Pandora® and Aha™ smartphone app integration², STARLINK™ cloud-based applications, including Yelp®, iHeartRadio®, SiriusXM® All Access Radio⁴, Traffic^{®12} and Travel Link^{®12}, high-resolution LCD touchscreen, AM/FM/CD player, HD Radio®, dual USB port/iPod® control, Bluetooth® audio streaming and hands-free phone and text messaging connectivity, and 3.5-mm auxiliary jack

Harman Kardon® audio system: 8 Harman Kardon® speakers and a 432-watt-equivalent amplifier

EyeSight® Driver Assist Technology⁶: Pre-Collision Braking System, Pre-Collision Throttle Management, Lane Departure and Sway Warning with Lane Keep Assist, Adaptive Cruise Control

STARLINK™ Safety Plus and Security Plus³: Includes STARLINK™ Safety Plus features and adds Stolen Vehicle Recovery, Remote Lock/Unlock, Remote Horn & Lights, Remote Vehicle Locator and Vehicle Security Alarm Notification

● Standard ○ Optional — Not equipped □ Available retailer-installed accessory

Impreza | Accessories



Cargo Net. Neatly holds cargo and prevents it from sliding while the vehicle is in motion.



Body Side Molding. Attractive, color-matched moldings coordinate with the styling of the vehicle while helping to protect doors from unsightly dings.



Sport Grille. Create a custom look for the front end of your Impreza by replacing the stock factory grille with the accessory Sport Grille.



Auto-Dimming Exterior Mirrors. Enhance your Auto-Dimming Mirror experience by adding the Auto-Dimming Exterior Mirrors with Approach Light.* When in traffic, the Auto-Dimming Exterior Mirrors help add to a safer driving experience by reducing headlight glare on the exterior mirrors. This occurs when excessive light is detected from the rear of the vehicle. The dimming level of the exterior mirrors is regulated by the level of light detected by the Auto-Dimming (Interior) Mirror.

*Requires accessory Auto-Dimming (Interior) Mirror.

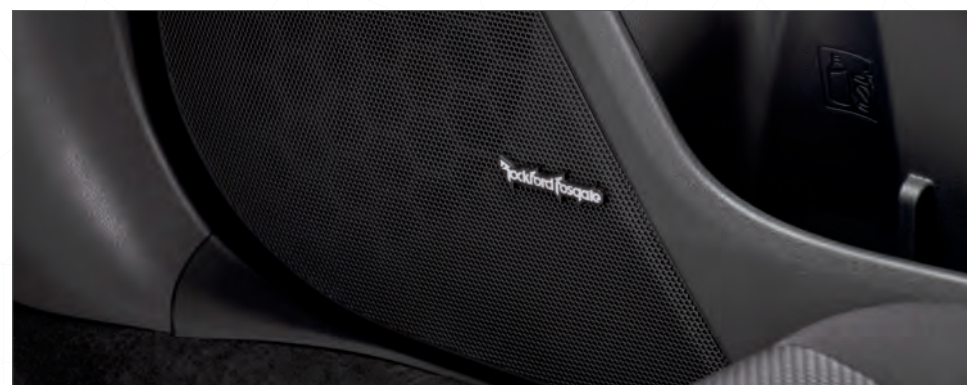

Rockford Fosgate® Audio Upgrade

Get ready to not only hear your music but feel it, too. The Rockford Fosgate® Audio Upgrade¹ elevates the standard Impreza audio system to a whole new level with an amplifier, upgraded speakers, and an integrated digital signal processor tuned to align the system to your liking.

Engineers developed this premium audio upgrade to specifically match the acoustics of your Impreza. The harder you push it, the better it performs, so feel free to crank up the volume as loud as you like. That's how you'll get the best experience.

¹ Not available on models equipped with Harman Kardon® audio system.



Cargo Tray. Removable tray helps to protect the cargo area from stains, dirt and other messes while providing a surface that helps reduce the shifting of cargo while driving.



Door Edge Guards. Help protect your door edges from dings and chips with custom-fit, body color-matched, stainless steel Door Edge Guards. They help preserve the appearance of your Subaru while seamlessly blending into the door design.



All-Weather Floor Mats. Custom-fitted, heavy-gauge floor mats help protect the vehicle carpet from sand, dirt and moisture.

Not intended for use on top of carpeted floor mats.



Remote Engine Starter. Allows vehicle to be started by pushing a button from the convenience of home or the office (up to 400 feet away depending on obstructions) so that the vehicle's interior temperature is more comfortable upon entry.

Lineartronic® CVT models only.



Side Sill Plates. Metallic-finished panels dress up the sill plates of the Impreza.



Splash Guards. Helps protect vehicle paint finish from stones and road grime.

Set of four.



Silver Metallic and Black Gloss Shift Knob. The ultimate shift knob for your Impreza. Silver metallic and black gloss combine with leather accents to make a stylish shift knob that gives your interior just the right edge.

Lineartronic® CVT models only.



Auto-Dimming Mirror with HomeLink.® This upgraded Auto-Dimming Mirror detects glare and darkens automatically to protect your vision while featuring an 8-point digital compass. Three backlit HomeLink® buttons can be programmed to operate most garage doors, security gates, home lighting and more. It can also provide you with the last status of your garage door (open or closed) if programmed to a compatible opener featuring two-way communication.



Let nothing hold you back.

When your passion is bigger than your cargo area, Genuine Subaru active lifestyle accessory attachments manufactured by Thule® are a smart way to securely transport larger gear like bikes, skis, snowboards, kayaks, paddleboards and more. Each carrier safely attaches to your roof rack and can be removed if needed.



Thule® Paddleboard Carrier



Thule® Bike Carrier – Roof-Mounted



Thule® Heavy-Duty Roof Cargo Basket

2018 Impreza | Owner Benefits

For additional Subaru resources, including owner's manuals, maintenance schedules, roadside assistance and more, log on to www.mysubaru.com

Protecting Your Investment

Once you're part of our family, we'll be there for you. Every Subaru comes with 24-hour roadside assistance for 3 years or 36,000 miles. If you have trouble on the road, a tow to the nearest Subaru retailer and other services is just a phone call away. And to protect you over the long haul, we offer Added Security[®]...ask for it by name—extended service agreements and maintenance plans that will help protect your car for up to 7 years or 100,000 miles. They're the only mechanical and maintenance plans backed by Subaru, and because we've been backing them for more than 30 years, they're agreements you can trust. Your retailer has full coverage details.

Subaru Badge of Ownership

Subaru owners are driven by their passions. Whether hiking to see a sunset or skiing through fresh powder. Paddling through rapids or playing fetch with their furry friend. For many, our exclusive Badge of Ownership lets them personalize their vehicle and express their interests. Owners can go to badgeofownership.com to order **FREE** Subaru Badge of Ownership lifestyle icons.



Durability



Responsible. Reliable. Ready to join the family.

At Subaru, we're committed to building a lasting, rewarding relationship with you and the world we share. We start by building our vehicles to last—it's why Subaru Impreza is the longest-lasting vehicle in its class.¹³ We also share your desire for a cleaner, greener world. In 2004, Subaru of Indiana Automotive, Inc. (SIA) became the first manufacturing facility in the U.S. to reach zero-landfill status—nothing from its manufacturing efforts ever goes into a landfill. Subaru is also headquartered in a zero-landfill office in Cherry Hill, N.J.

Warranties

New Car Limited Warranty 3 years or 36,000 miles, whichever comes first.

Powertrain Limited Warranty 5 years or 60,000 miles, whichever comes first.

Wear Item Limited Warranty 3 years or 36,000 miles, whichever comes first. Repairs to the following items will also be covered under Wear Item Limited Warranty:

- Brake Pads
- Wiper Blades
- Clutch Linings
- Transmitter Batteries

Rust Perforation Limited Warranty 5 years, unlimited mileage.

24-hour Roadside Assistance 3 years or 36,000 miles, whichever comes first.

1 2018 EPA fuel economy estimates. Actual mileage may vary. 2 Compatible smartphone and applications required. For applications to operate, latest version of each application is required. Data provided by smartphone is displayed on the audio system screen. Some state laws prohibit the operation of handheld electronic devices while operating a vehicle. Smartphone apps should only be launched when vehicle is safely parked. Your wireless carrier's rates may apply. 3 Activation and subscription required. See your retailer for details. 4 Activation and required monthly subscription sold separately. Includes 4-month trial subscription. See your retailer. 5 Available only with other features. See Optional Equipment listing. 6 EyeSight is a driver assist technology, which may not operate optimally under all driving conditions. The driver is always responsible for safe and attentive driving. System effectiveness depends on many factors such as vehicle maintenance, weather and road conditions. Pre-Collision Braking System is designed to provide automatic braking that either prevents a collision or reduces the severity of a frontal impact. Pre-Collision Throttle Management is designed to reduce acceleration and minimize the severity of certain frontal impacts. Adaptive Cruise Control and Brake Light Recognition are designed to assist the driver and are not substitutes for safe and attentive driving. Lane Departure and Sway Warning and Lane Keep Assist operate only when the lane markings are visible and system effectiveness depends on many factors. See Owner's Manual for complete details on system operation and limitations. 7 Blind-Spot Detection, Lane Change Assist and Rear Cross-Traffic Alert are systems designed to assist the driver by monitoring the rear and side areas of the vehicle during a lane change or reversing and are not a substitute for safe and attentive driving. 8 The Reverse Automatic Braking System is not a substitute for safe and attentive driving. System effectiveness depends on many factors, such as vehicle maintenance, weather and road conditions. Always exercise caution and use vehicle mirrors and the Rear-Vision Camera when backing up. See Owner's Manual for complete details on system operation and limitations. 9 Activation and required subscription sold separately. Includes 1-year trial subscription. See retailer for details. 10 The Supplemental Restraint System (SRS) (airbags) affords the driver and the front and rear outboard passengers additional protection in moderate to severe frontal and side-impact collisions. This system provides supplemental protection only, and seatbelts must be worn in order to avoid injuries to out-of-position occupants upon airbag deployment and to provide the best combined protection in a serious accident. Children should always be properly restrained in the rear seat. 11 Requires Lineartronic[®] CVT. 12 Activation and required subscription sold separately. Includes 3-year trial subscription. See your retailer for details. 13 Based on the average of vehicles in operation vs. new registrations for each model year using IHS Markit data as of October 2016 for MY2007–2016.

2018 Impreza | Dimensions

Impreza Sedan

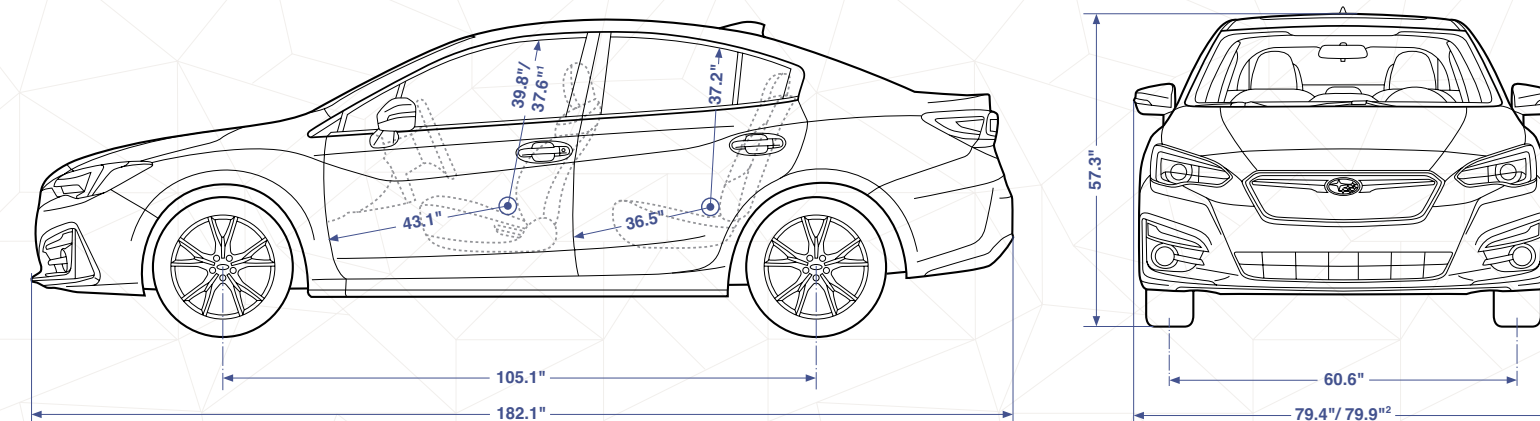

Impreza 5-Door

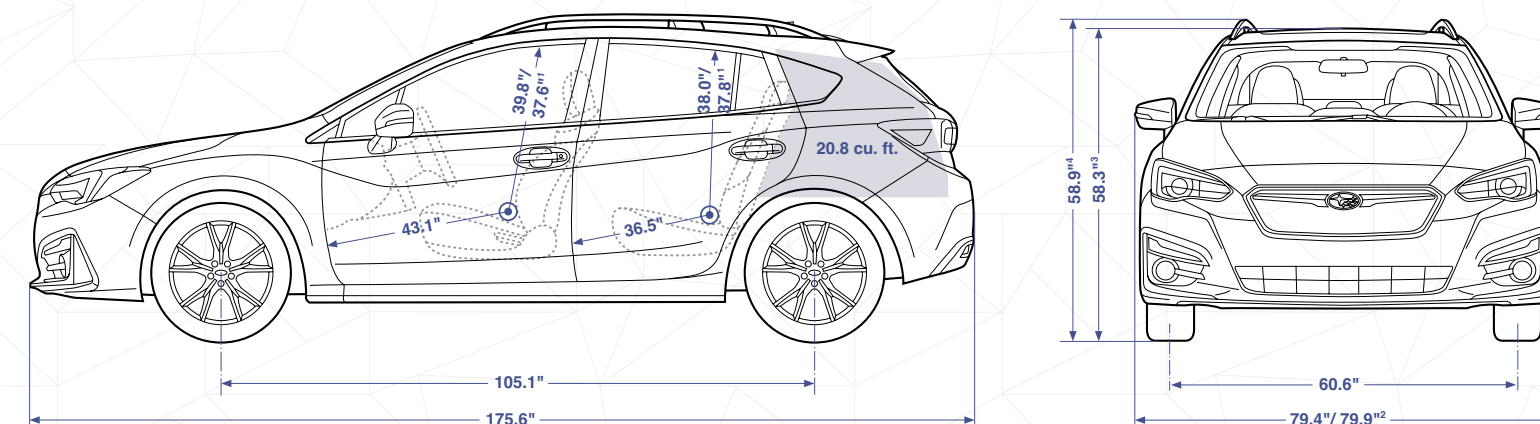

Length/Width/Height

Sedan: 182.1 inches/70.0 inches (79.4/79.9² including mirrors)/57.3 inches
5-door: 175.6 inches/70.0 inches (79.4/79.9² including mirrors)/57.3 inches (58.3⁴/58.9⁴)

Wheelbase

105.1 inches

Track (front/rear)

60.6 inches/60.8 inches

Base curb weight (manual/automatic)

Sedan
2.0i: 2,974 lbs/3,034 lbs
2.0i Premium: N/A/3,073 lbs
2.0i Sport: 3,075 lbs/3,131 lbs
2.0i Limited: N/A/3,108 lbs
5-door
2.0i: 2,985 lbs/3,047 lbs
2.0i Premium: N/A/3,093 lbs
2.0i Sport: 3,082 lbs/3,135 lbs
2.0i Limited: N/A/3,128 lbs

Headroom (front/rear)

Sedan: 39.8 inches/37.2 inches (with moonroof: 37.6 inches/37.2 inches)
5-door: 39.8 inches/38.0 inches (with moonroof: 37.6 inches/37.8 inches)

Legroom (front/rear)

43.1 inches/36.5 inches

Shoulder room (front/rear)

56.7 inches/55.6 inches

Hip room (front/rear)

55.1 inches/55.2 inches

Passenger volume

Sedan: 99.8 cubic feet (with moonroof: 96.8 cubic feet)
5-door: 100.9 cubic feet (with moonroof: 97.5 cubic feet)

Cargo volume

Sedan: 12.3 cubic feet
5-door: 20.8 cubic feet (55.3 cubic feet with rear seat lowered)

1 With available moonroof. Moonroof availability varies by trim level.
 2 Mirrors with integrated turn signals.
 3 2.0i Sport models.
 4 Including roof rails.

2018 Impreza | Colors

Paint

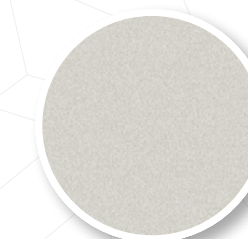

Crystal White Pearl

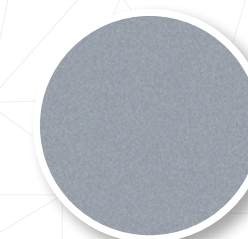

Ice Silver Metallic

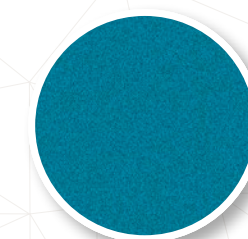

Island Blue Pearl

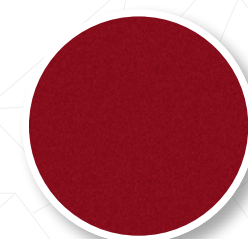

Lithium Red Pearl

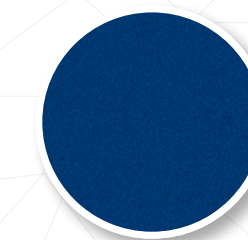

Lapis Blue Pearl

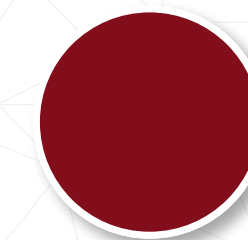

Crimson Red Pearl

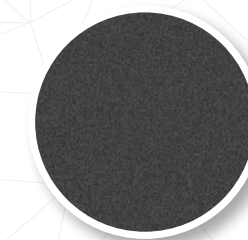

Magnetite Gray Metallic

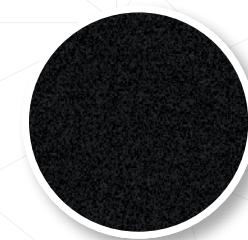

Crystal Black Silica

Upholstery



Black Cloth (BC)



Ivory Cloth (IC)



Black Sport Cloth (BSC)

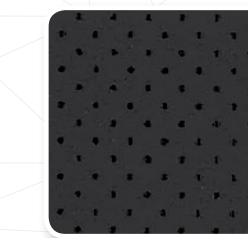

Black Leather (BL)



Ivory Leather (IL)

Color Combinations

	2.0i – 2.0i Premium	2.0i Sport	2.0i Limited
Crystal White Pearl	BC or IC	BSC	BL or IL
Ice Silver Metallic	BC	BSC	BL
Island Blue Pearl	BC	BSC	BL
Lithium Red Pearl	–	BSC	–
Lapis Blue Pearl	IC	BSC	IL
Crimson Red Pearl	IC	–	IL
Magnetite Gray Metallic	BC	BSC	BL
Crystal Black Silica	BC or IC	BSC	BL or IL

– Not available

Take a Guided Tour

It's the ultimate way to get to know the Impreza on your terms. Get up close and personal with color configurators, videos, 360-views, interactive content and so much more.



Online:
tour.subaru.com/Impreza2018

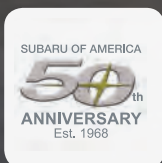

These brochures were printed with vegetable-based inks and produced using a "Green Printing Process." The Forest Stewardship Council® (FSC®) is an international organization that brings people together to find solutions which promote responsible stewardship of the world's forests and environments.

By producing these brochures in a green way rather than by traditional methods, we saved 50 trees preserved for the future; 23,183 gallons of wastewater flow saved; 1,552 lbs solid waste not generated; 4,275 lbs net greenhouse gases prevented; 22,000,000 BTUs energy not consumed. Calculations provided by Environmental Paper Network. FSC® is not responsible for any calculations on saving resources by choosing this paper.

This brochure is printed in the U.S.A. on 10% recycled paper. ©2017 Subaru of America, Inc. 18IMP SRB.525 (S-20971, 100K, 8/17, CG)

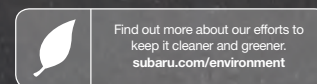

Love. It's what makes a Subaru, a Subaru.

