

ALL-NEW JAGUAR XF



THE ART OF PERFORMANCE





BY APPOINTMENT TO
HM THE QUEEN
MANUFACTURERS OF
MOTOR VEHICLES
JAGUAR LAND ROVER LIMITED
COVENTRY



BY APPOINTMENT TO
HRH THE DUKE OF EDINBURGH
MANUFACTURERS OF
MOTOR VEHICLES
JAGUAR LAND ROVER LIMITED
COVENTRY



BY APPOINTMENT TO
HRH THE PRINCE OF WALES
MANUFACTURERS OF
MOTOR VEHICLES
JAGUAR LAND ROVER LIMITED
COVENTRY



JAGUAR

THE ART OF PERFORMANCE

Every day we push performance to its limit. Our performance. Our cars' performance.
We innovate, we engineer, we design. We master rules and then break them.
Only to push further. Past the limits of convention. This is when performance becomes art.

Jaguar. The Art of Performance.



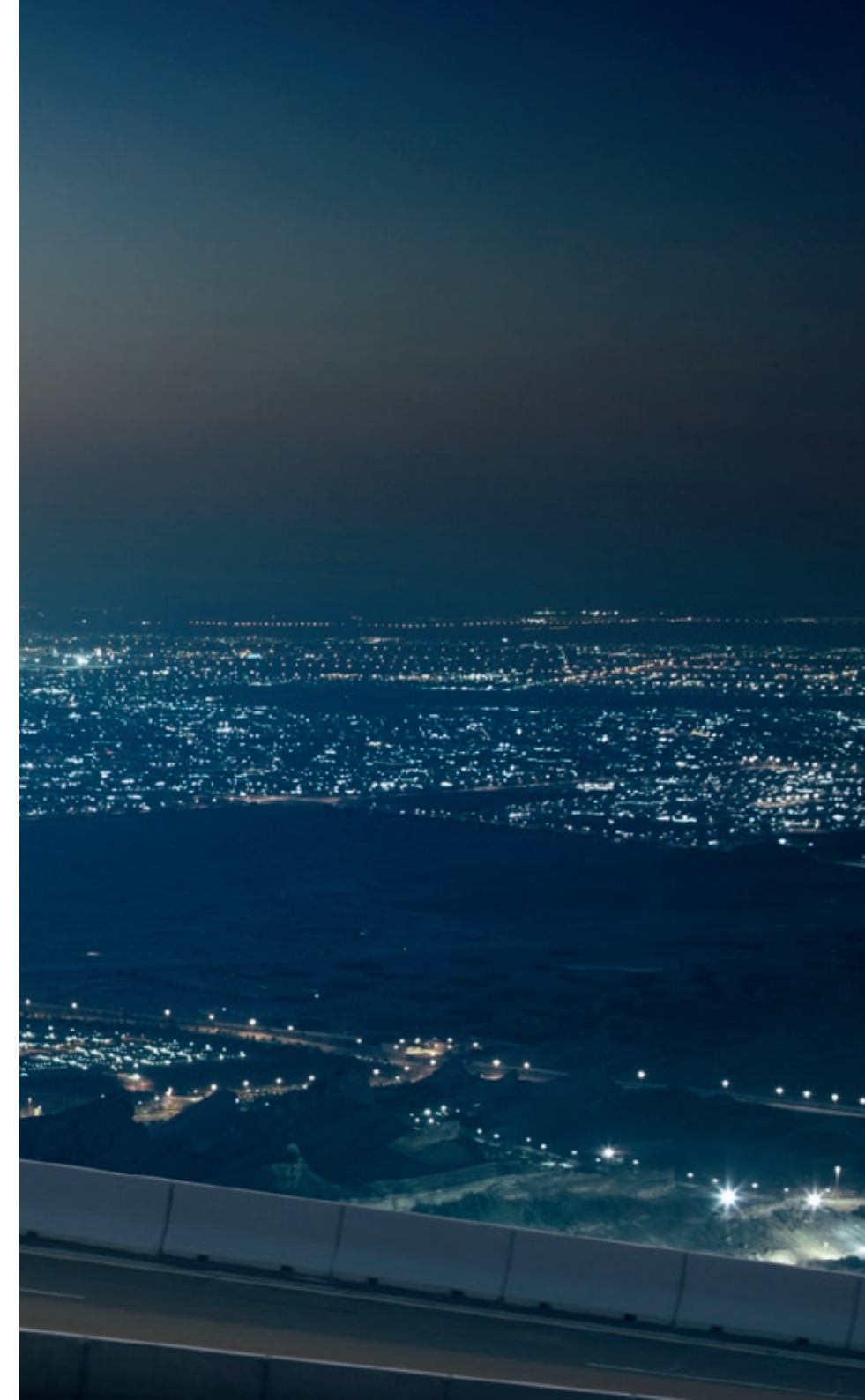

CONTENTS

INTRODUCTION

The Concept of the XF	07
The XF - The Facts	08

DESIGN

Exterior Principles	10
Exterior Aerodynamics	12
Interior	17
Interior Space	19

PERFORMANCE

Engines	20
Advanced Aerodynamics	22
Lightweight Aluminum Architecture	25
Chassis and Suspension	26
Advanced Driving Dynamics	29

DRIVING TECHNOLOGY

All Surface Progress Control	30
Advanced Drivetrain Technology	33
Torque Vectoring	34
Stability and Control	37
Head-Up Display	39

INFOTAINMENT

Jaguar InControl® Technologies	40
InControl Touch™	43
InControl Touch Pro™	45
Audio	46

ASSISTANCE AND EFFICIENCY

Advanced Driver Assistance	48
Efficient Technologies	50

PERSONALIZATION

The XF - Your Choice	52
Choose your Engine	54
Choose your Model & Packages	56
Choose your Color	64
Choose your Wheels	66
Choose your Interior	68
Choose your Jaguar Accessories	80
Technical Specifications	82
Dimensions	84

JAGUAR WORLD

Jaguar Experience	86
The World of Jaguar	88
Glossary and Legal Information	90



Scan to find out more about the all-new Jaguar XF.

VEHICLE SHOWN: XF PRESTIGE IN RHODIUM SILVER WITH 19" RAZOR ALLOY WHEELS

SOME OF THE VEHICLES FEATURED IN THE PHOTOGRAPHS THROUGHOUT THIS BROCHURE ARE EUROPEAN MODELS AND MAY NOT BE AVAILABLE IN NORTH AMERICA. PLEASE CONSULT YOUR LOCAL JAGUAR RETAILER FOR SPECIFIC MODEL AVAILABILITY.





INTRODUCTION

THE CONCEPT OF THE XF

The XF is all-new. Building on the success of the most award-winning Jaguar vehicle ever. Possessing an unrivalled combination of style and substance. Delivering an utterly seductive blend of design, dynamics and refinement to create a car that offers both excitement and efficiency⁷. All enhanced by state-of-the-art technologies that keep you connected and entertained.

The XF sits in the Jaguar sedan range between the taut athleticism of the XE and the supreme luxury of the XJ. The fusion of these outstanding Jaguar attributes is what creates the XF – one of the most dynamic, premium sports sedan of its generation.

VEHICLE SHOWN: XF S IN GLACIER WHITE WITH OPTIONAL 20" LABYRINTH ALLOY WHEELS AND BLACK PACK
Disclaimers apply. Please see page 91 for further details.

THE XF - THE FACTS

An outstanding combination of advanced engineering, the latest technology and contemporary design sets the XF apart.

ADVANCED AERODYNAMICS

The XF is capable of achieving a low drag coefficient of just Cd. 0.29 meaning it cuts through the air, reducing wind noise for enhanced refinement and improved efficiency⁷. Even the underside of the car is aerodynamically designed to be as smooth as possible, while apertures in the front bumper optimize airflow through the wheel arches.

— JAGUAR ELITECARE —
**BEST IN CLASS
COVERAGE***
— 5 YEARS 60,000 MILES —

JAGUAR ELITECARE

Enjoy your Jaguar with complete peace of mind. The XF is now backed by the Best-In-Class Jaguar EliteCare*, our exceptional 5 year / 60,000 mile coverage program including New Vehicle Limited Warranty, Complimentary Scheduled Maintenance, Roadside Assistance and InControl Remote & Protect™.

VEHICLE SHOWN: XF S IN GLACIER WHITE WITH OPTIONAL 20" LABYRINTH ALLOY WHEELS AND BLACK PACK

*Class is cars sold by luxury automobile brands and claim is based on total package of warranty, maintenance and other coverage programs. For complete details regarding Jaguar EliteCare coverage, visit JAGUARUSA.COM, call 1.800.4.JAGUAR or visit your local Jaguar Retailer. Disclaimers apply. Please see page 91 for further details.

BREADTH OF PERFORMANCE

Powerful and refined, for a thrilling and rewarding drive. The 3.0 V6 engine is available in two power outputs - 340HP and 380HP. The Supercharged engine offers economy and performance, achieving 0-60mph in as low as 5.0 seconds⁸.

CRAFTSMANSHIP AND SPACE

Contemporary craftsmanship and a beautiful, luxurious interior with the space to stretch out and enjoy every journey. Compared with the previous XF, rear knee room has increased by 0.9 inches. Rear legroom has increased by 0.6 inches, all adding up to greater comfort and wellbeing for passengers.

LIGHTWEIGHT ALUMINUM ARCHITECTURE

The Lightweight Aluminum Architecture developed by Jaguar helps to make the XF lighter, stronger and 28 percent stiffer than the previous XF. It is up to 265 lbs lighter than its predecessor, improving handling, performance and efficiency⁷.

ADDED INTELLIGENCE

The XF offers a variety of optional advanced driver assistance features including, Traffic Sign Recognition with Adaptive Speed Limiter, Lane Keep Assist with Driver Condition Monitor, Autonomous Emergency Braking and Adaptive Cruise Control with Queue Assist⁵.



ADVANCED DRIVETRAIN TECHNOLOGY

The XF offers unique All Wheel Drive with Intelligent Driveline Dynamics and Adaptive Surface Response. This maximizes the legendary Jaguar handling, agility and ride, and gives added confidence in most conditions.

ALWAYS CONNECTED

Every drive in the XF is enhanced by Jaguar InControl[®] Technologies. Jaguar InControl[®] is a suite of products and services that connects you with your XF and links the XF to the wider world. It ensures you are always in touch.



DESIGN EXTERIOR PRINCIPLES



DESIGN
PURITY

ADAPTIVE
LED HEADLAMPS

"It's about paring it down to the bare essentials. Good designers have always said less is more."

Ian Callum, Jaguar Design Director.

The XF demonstrates the Jaguar principles of design purity. Strong lines radiate dynamic character and enhance the vehicle capabilities - be it improving aerodynamics, visibility, stability or safety. The XF is available with adaptive LED headlamps complementing Jaguar signature J-Blade daytime running lights and giving the vehicle a striking on-road presence. The quality of LED light is close to daylight, helping your eyes distinguish objects more easily and reducing fatigue at night.

VEHICLE SHOWN RIGHT: XF S IN GLACIER WHITE WITH OPTIONAL BLACK PACK



EXTERIOR AERODYNAMICS

 **F-TYPE
INSPIRED DESIGN**

**AERODYNAMIC
DESIGN**

At the rear, the XF tail lights feature a distinctive, Jaguar F-TYPE inspired, double roundel and intersecting horizontal detail. The LED brake lights are not only brighter than halogen bulbs, they use less energy - contributing to the overall drive for greater efficiency. LEDs also illuminate faster - so following drivers can react more quickly to braking. Within the tail lights is a pinstripe graphic - one of the many exquisite finishing touches on the XF.

The sweeping exterior design of the XF is naturally aerodynamic. Its advanced form enhances handling, dynamics and refinement. Even the trunk lid height and pitch, as well as its overall curvature and subtle spoiler, are designed to reduce drag and increase downforce. For example, the body generates as much as 110 lbs of extra downforce at 99 mph for greater stability and helps the XF maintain its connection with the road.

VEHICLE SHOWN: XF PRESTIGE IN RHODIUM SILVER WITH 19" RAZOR ALLOY WHEELS

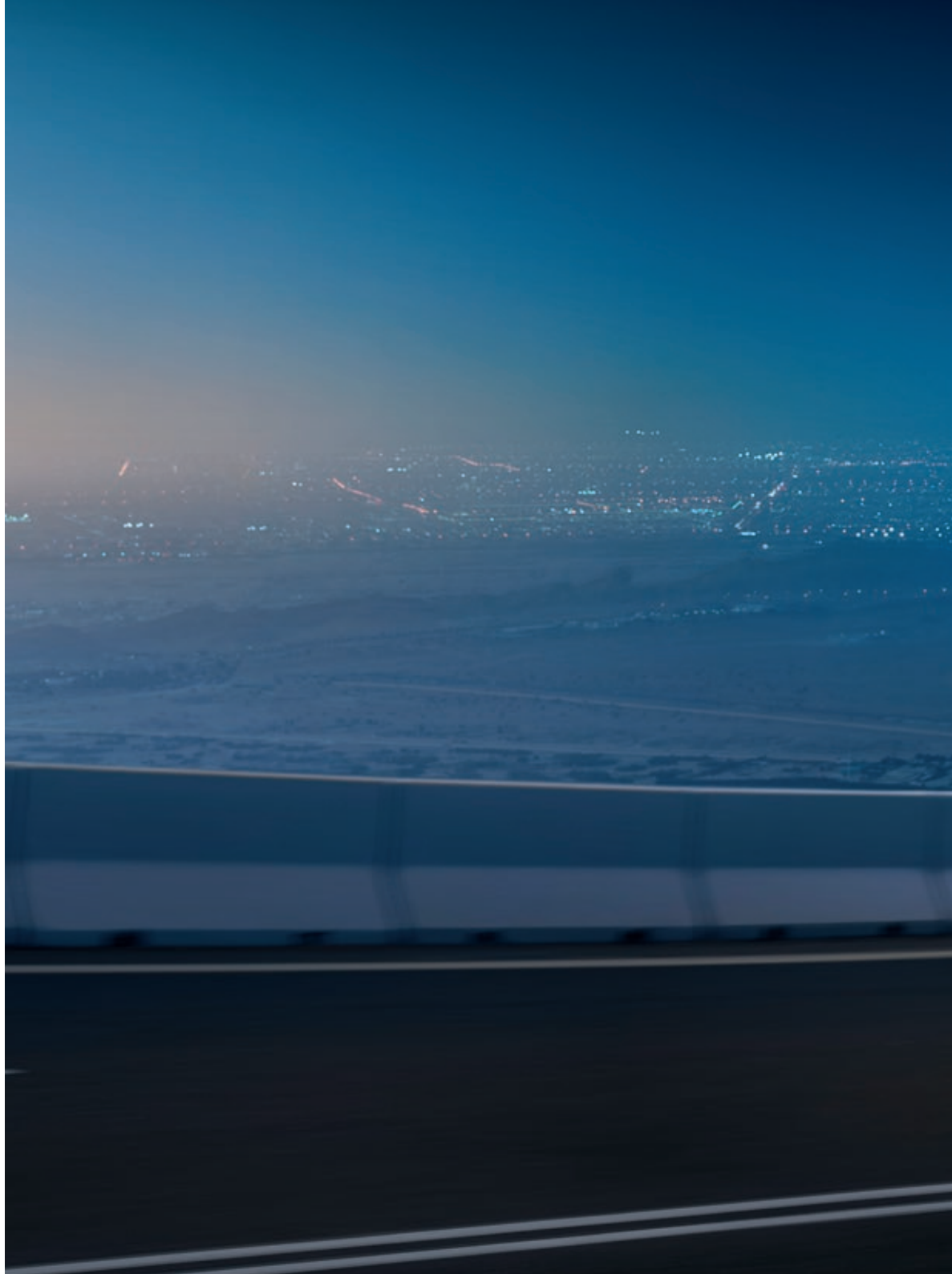









Darkness
Oliver Dobby
Darkness
4/12

70 90 110 130
50 0 150
30 10 170 190

3 4 5
P

HOME 08:30

Darkness
Oliver Dobby
73°F
Outside 59°F

Hi's Phone
 Vodafone
High St
 Kensington

SYNC

MAX MAX A/C A/C

STOP

P R N D S



INTERIOR



**DRAMATIC START-UP
SEQUENCE**

**CONTEMPORARY
CRAFTSMANSHIP**

Open the door and the Start button entices you inside. Pulsing with a heartbeat it creates an emotional connection between driver and machine. Its 72 per minute double beat is the same as a jaguar cat at rest. The XF is poised, ready for action. Now push the Start button. With perfect choreography, air vents rotate open, the JaguarDrive Selector rises smoothly, the engine growls - all inspiring you to anticipate the drive ahead.

The XF interior offers outstanding comfort, a sense of wellbeing and a wealth of choice. Whichever the XF interior combination you choose, materials used are always of the highest quality. Leather and finishes are selected with the greatest care to ensure that, inside the XF, everything is luxurious to the touch. Whether you prefer aluminum, carbon fiber, or wood veneer finishes to complement the beautiful selection of materials, your XF will always look and feel just right.

INTERIOR SHOWN LEFT AND PREVIOUS PAGE: XF S FEATURING LIGHT OYSTER/JET SEAT WITH JET UPPER FASCIA WITH CONTRAST STITCH, JET CARPET AND JET HEADLINING. OPTIONAL EQUIPMENT FITTED



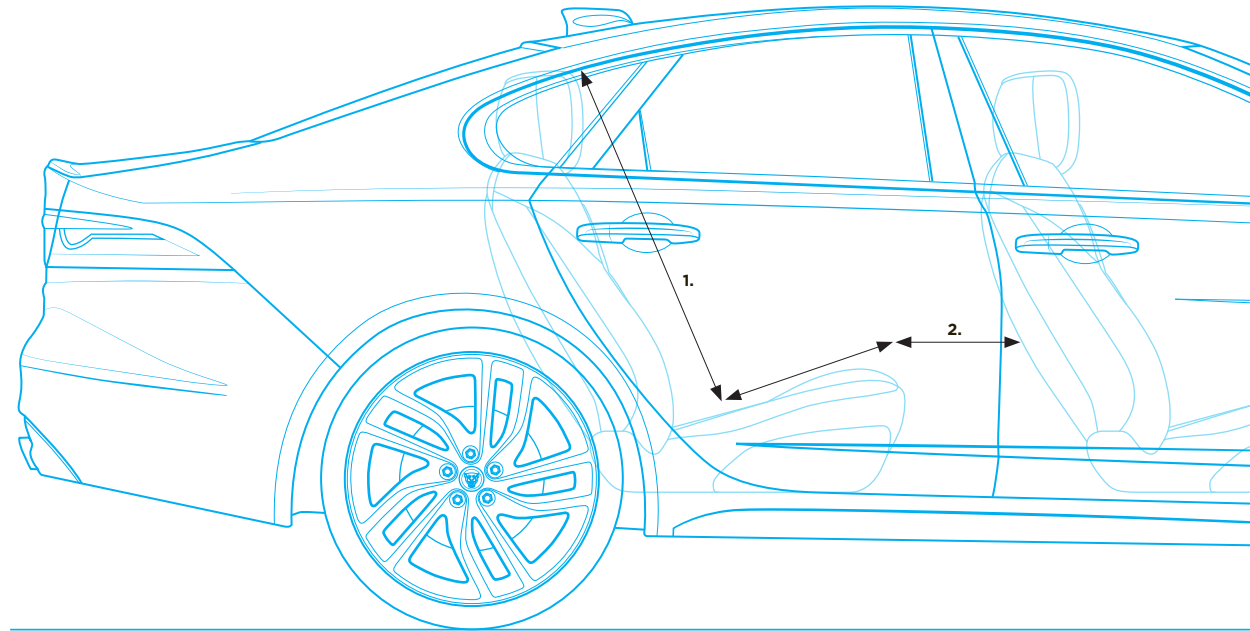

1. Headroom 38 inches 2. Knee room 3 inches

INTERIOR SPACE

SPACIOUS REAR KNEE ROOM

The rear of the XF cabin is a destination of luxury, choice and space. Compared with the previous XF, rear knee room has increased by 0.9 inches. Rear legroom has increased by 0.6 inches and rear headroom has risen by up to 1.06 inches, all adding up to greater comfort and wellbeing for passengers. Building on the drama of its predecessor's interior, mood lighting can also enhance the atmosphere of the XF. Opt for Configurable Interior Mood Lighting and you'll have a choice of ten interior colors. The choice continues with optional four-zone air conditioning, giving individual rear passengers the opportunity to set their own temperature and airflow. Keeping your car comfortable regardless of the conditions outside, the XF air conditioning system has undergone punishing real world tests in ambient temperatures ranging from 122°F to -22°F. In addition, the 40:20:40 seating configuration offers increased available volume and versatility.

INTERIOR SHOWN: XF S FEATURING LIGHT OYSTER/JET SEAT WITH CONTRAST STITCH, JET CARPET AND JET HEADLINING

PERFORMANCE ENGINES



STOP/START TECHNOLOGY

The XF offers a choice of refined, efficient⁷ engines – both delivering a dynamic driving experience and responsive Jaguar performance. The XF engines are equipped with Stop/Start technology and smart regenerative charging – harvesting kinetic energy from braking to charge the battery – for maximum economy, especially during city driving.

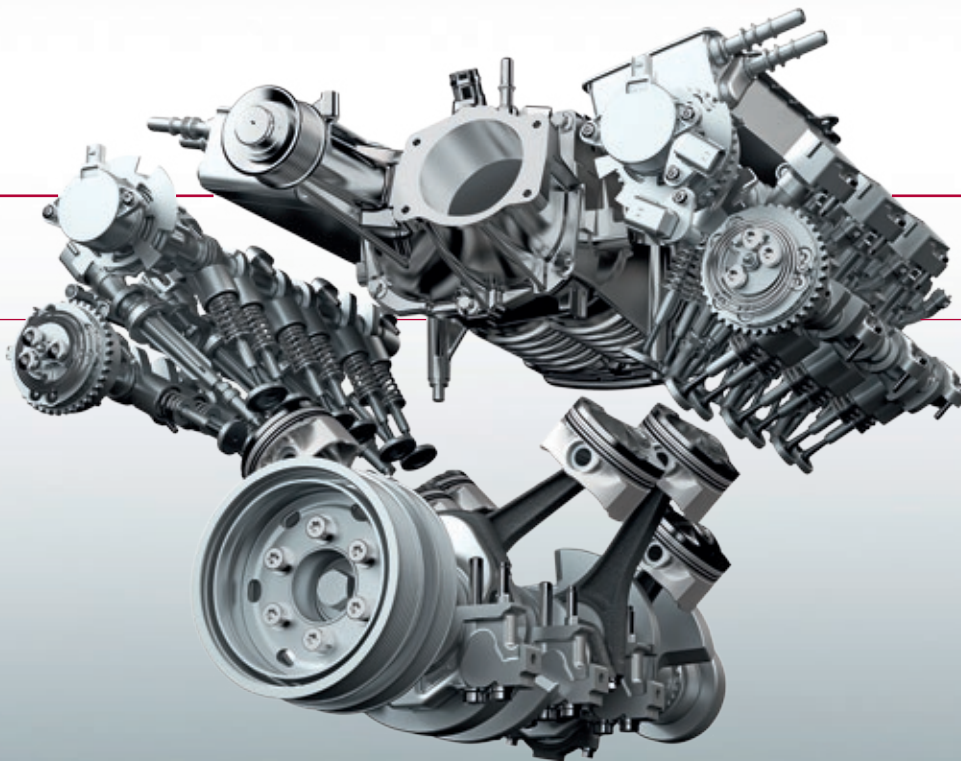

RESPONSIVENESS AND PERFORMANCE

0-60mph from 5.0 sec

The advanced XF engines offer power and responsiveness throughout the rev range, while improving efficiency⁷. The acclaimed 3.0 liter V6 340 HP engine delivers outstanding torque of 332 lb-ft for greater responsiveness, while fuel economy has been improved by up to 15% (AWD 340hp goes from 20 mpg to 23 mpg average). Only available on S and shared with the Jaguar F-TYPE, the 3.0 liter V6 Supercharged 380 HP engine is capable of 0-60mph in 5.0 seconds⁸. These all-aluminum engines deliver instant access to high levels of torque at all engine speeds and a unique soundtrack.

VEHICLE SHOWN: XF S IN GLACIER WHITE WITH OPTIONAL 20" LABYRINTH ALLOY WHEELS AND BLACK PACK
Disclaimers apply. Please see page 91 for further details.



ADVANCED AERODYNAMICS



LOW DRAG

| Cd. 0.29

The XF form has been rigorously optimized for aerodynamic efficiency and stability at highway speeds. With a drag coefficient as low as Cd. 0.29, the XF cuts through the air - reducing fuel consumption and lowering emissions. Every element exploits the maximum aerodynamic potential while preserving the stunning proportions of the XF. Vertical apertures in the front bumper outer edges channel air through vents in the wheel arches and out over the front wheels. The airflow then passes along the XF sides where the doors have a flatter cross sectional profile to minimize air pressure differences and contribute further to reduced drag. Even the extensive under body protection is designed to make the XF as efficient⁷, economical and refined as possible.

VEHICLE SHOWN: XF PRESTIGE IN BLACK BERRY WITH 20" MATRIX ALLOY WHEELS AND OPTIONAL LED HEADLAMPS
Disclaimers apply. Please see page 91 for further details.



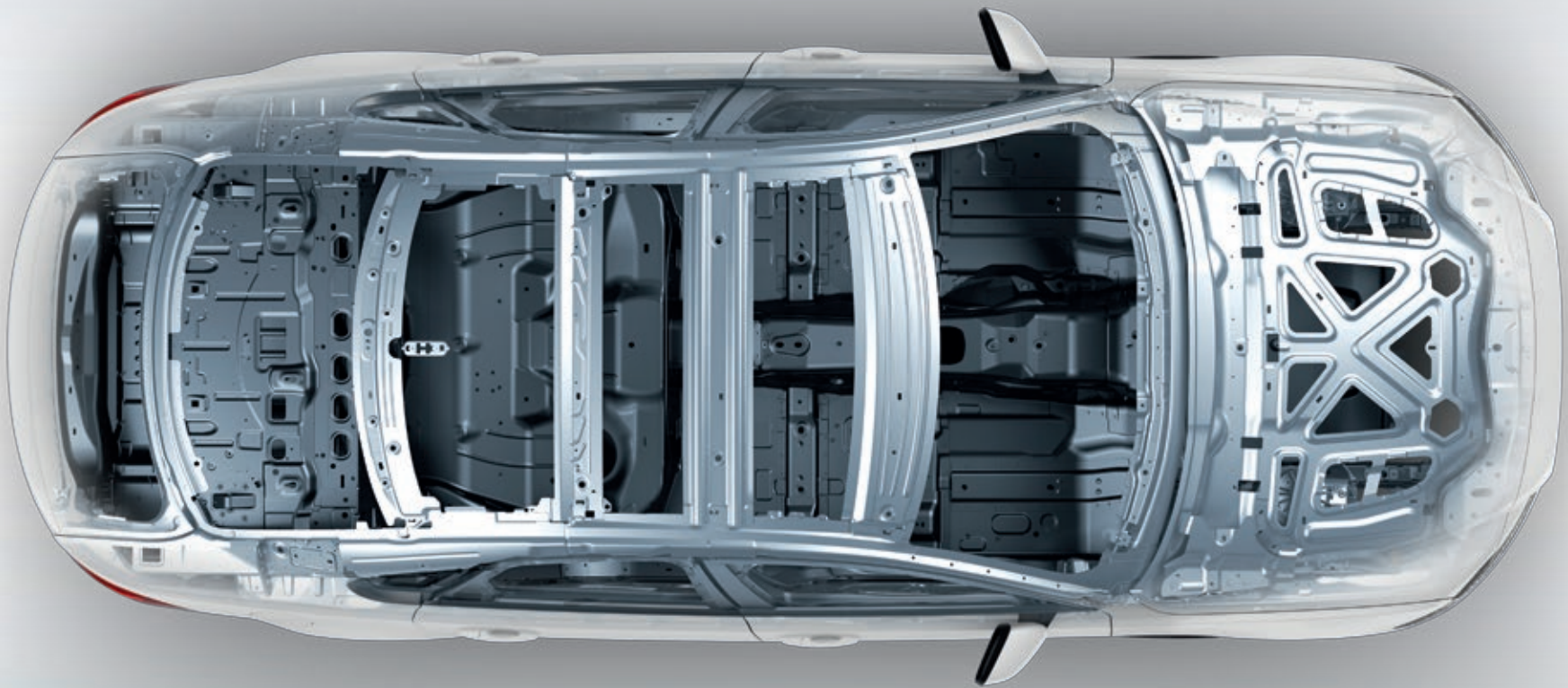

LIGHTWEIGHT ALUMINUM ARCHITECTURE

 **STRONG** | **RIGID** | **75% ALUMINUM**

Jaguar has been at the forefront of aluminum car construction for more than a decade. Our latest innovation is Lightweight Aluminum Architecture, which is significantly lighter, stronger and 28 percent stiffer than the structure used in the previous generation XF. Aluminum has also been used to form the body sides, hood and front wings of the XF. Lightweight aluminum panels are bonded together with adhesive, then punched with zinc-coated, boron steel rivets that compress the adhesive to form an airtight bond and a remarkable strong, rigid structure. This cutting edge process, coupled with the Lightweight Aluminum Architecture, contributes towards weight savings of up to 265 lbs over the XF it replaces.

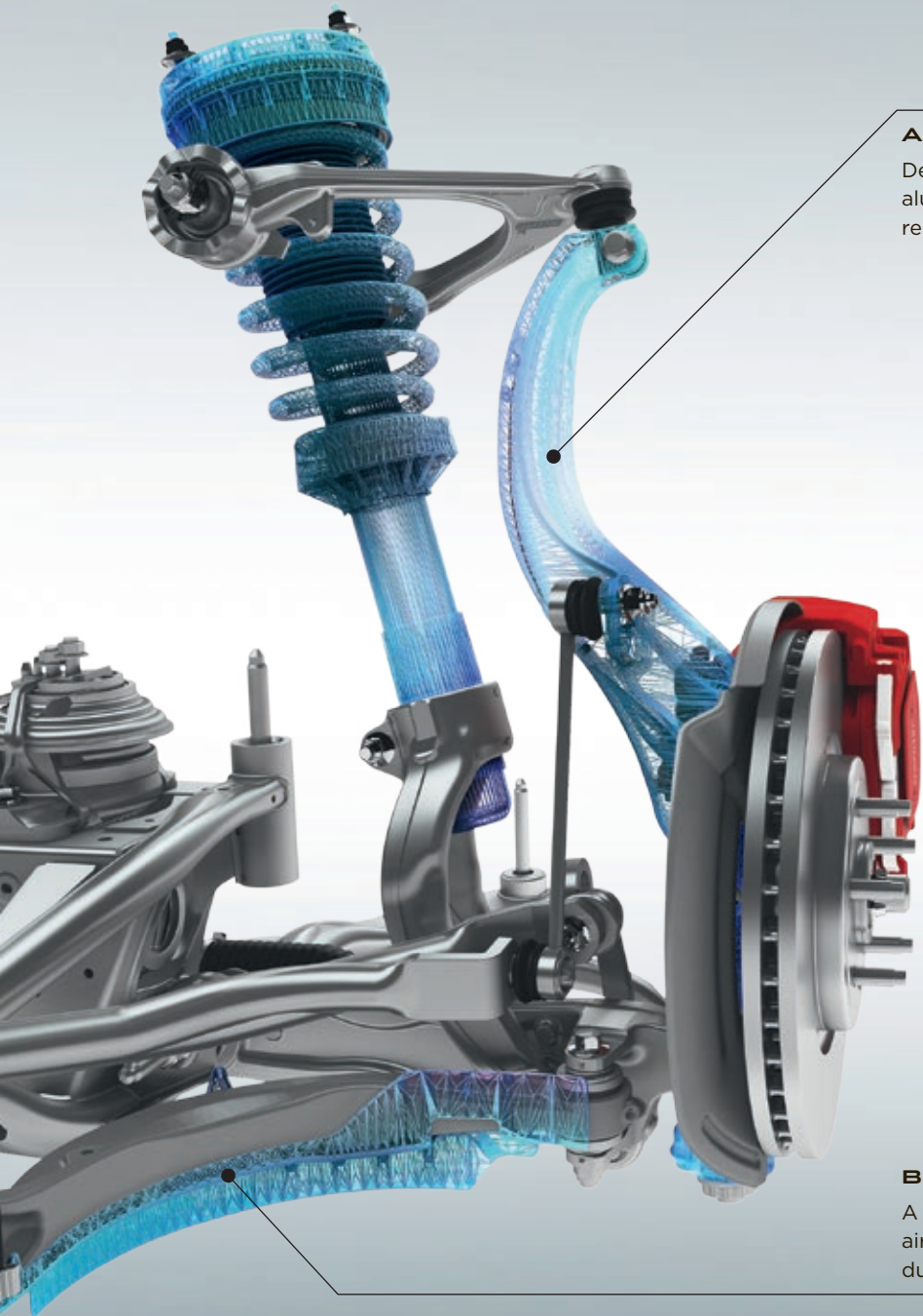

ALUMINUM FRONT KNUCKLE

Designed to optimize stiffness and strength, the lightweight aluminum front knuckle helps improve the XF agility, responsiveness and refinement for sports car-like control.

CHASSIS AND SUSPENSION



UNIQUE SUSPENSION
TECHNOLOGY

COMFORTABLE
AND DYNAMIC

The XF responds with agility and performs with dynamism while maintaining ride comfort – it's a unique balance that makes it a Jaguar. The ideal foundation for these driving dynamics is the light, yet exceptionally strong and stiff, Lightweight Aluminum Architecture with its near 50:50 weight distribution.

The sophisticated front and rear suspension systems complete a chassis that achieves a superb combination of sportiness and refinement. Advanced damper technologies – both passive or adaptive – improve ride quality still further and extend the XF breadth of dynamic capabilities. The suspension control, agility and feedback give the XF the spirit of a sports car.

BRAKE SCOOP

A glass-filled polypropylene brake scoop channels air onto the brakes for enhanced brake performance during enthusiastic driving.

INTEGRAL LINK REAR SUSPENSION

Integral Link suspension allows the XF to realize an ideal combination of refined, luxurious ride and sharp, responsive handling. The system separates and independently manages the lateral, longitudinal and vertical forces acting on the suspension for enhanced control and comfort. Many components are forged or hollow-cast aluminum – the optimum production techniques for strong, lightweight suspension.

ADAPTIVE DYNAMICS

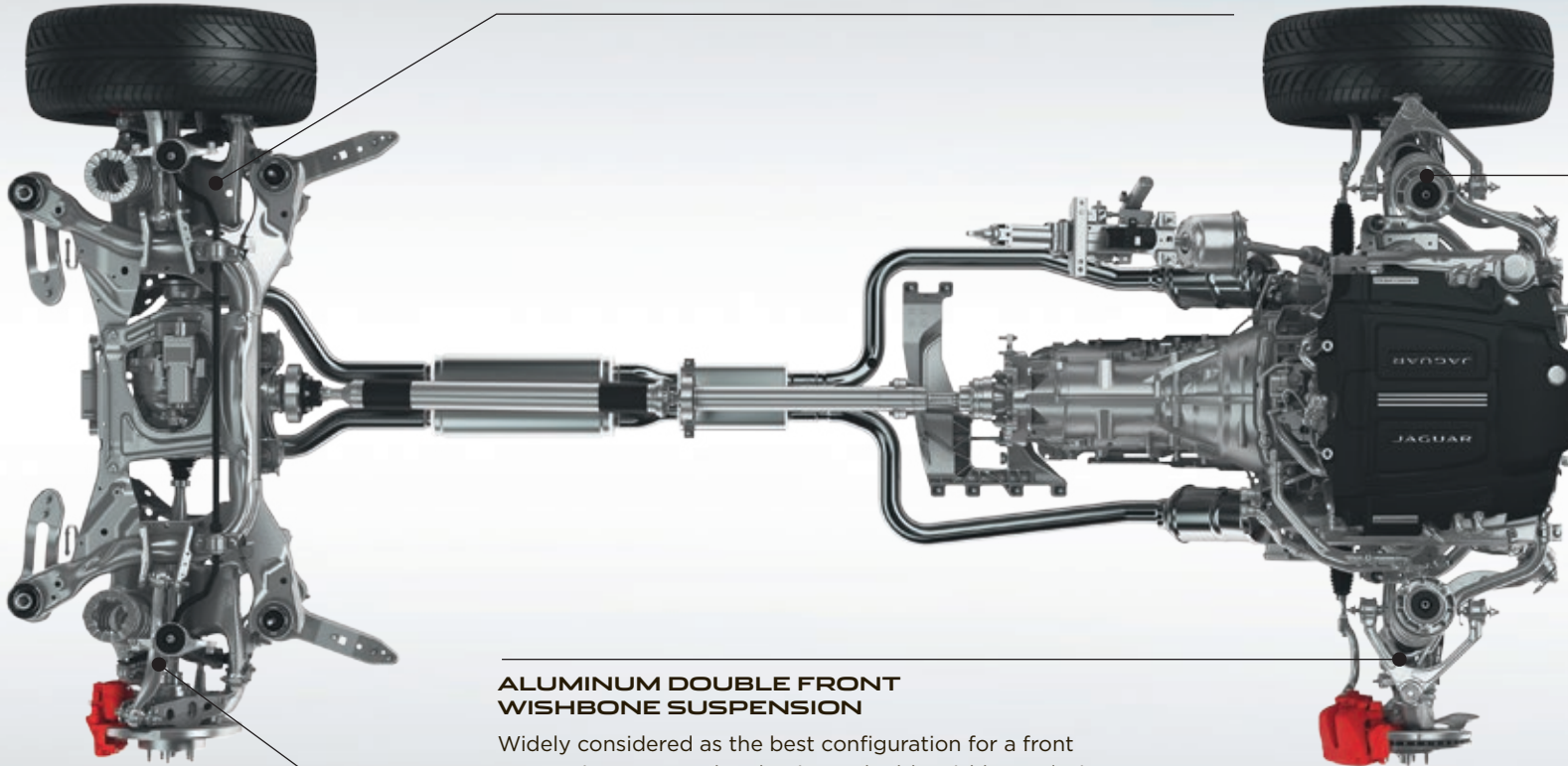

ALUMINUM DOUBLE FRONT WISHBONE SUSPENSION

Widely considered as the best configuration for a front suspension system, the aluminum double wishbone design is modelled closely on the F-TYPE for precise handling and steering response.

ADAPTIVE DYNAMICS

The optional Adaptive Dynamics* system delivers both precise dynamics and a supple, luxurious ride by monitoring wheel position and body movements. The Active Dampers adjust the suspension to provide the optimum balance between comfort and refinement⁵.

*Standard on the XF S.
Disclaimers apply. Please see page 91 for further details.



ADVANCED DRIVING DYNAMICS



MAXIMIZING AGILITY

CONTINUOUSLY ADAPTING

ADAPTIVE DYNAMICS

Whether you're accelerating on the highway, cornering on country roads or navigating around town, optional Adaptive Dynamics modifies the XF response to match the conditions and your driving style. It analyzes acceleration, cornering, throttle and brake pedal activity, as well as kick down activation. Steering and body movement are also analyzed up to 500 times a second. Using this information, electronically controlled adaptive dampers then constantly adjust the suspension settings and maintain the poise and comfort of the XF⁵.

ELECTRIC POWER ASSISTED STEERING

The next generation Electric Power Assisted Steering (EPAS) featured in the XF offers outstanding feedback, control and immediate power assistance. Allowing sophisticated computer management to adapt the levels of steering support, EPAS gives you fine control at speed and comprehensive assistance during slow maneuvering. It also enables advanced optional driver assist features such as Lane Keep Assist and Park Assist⁵.

CONFIGURABLE DYNAMICS AND DYNAMIC MODE

Bringing technology from the F-TYPE, the optional Configurable Dynamics system featured in the XF allows you to set up the XF dynamics for suspension, throttle mapping, gearbox shift points and steering to suit your performance driving needs. It is activated when Dynamic Mode is selected in JaguarDrive Control. Dynamic Mode enlivens the sporting character of the XF. It sharpens throttle response, increases steering weighting and performs gearshifts more quickly and at higher engine speeds. Even more visual drama is brought to the cabin with the instrument dials taking on a red glow. Dynamic Mode enhances your connection with the sports car performance of the XF.

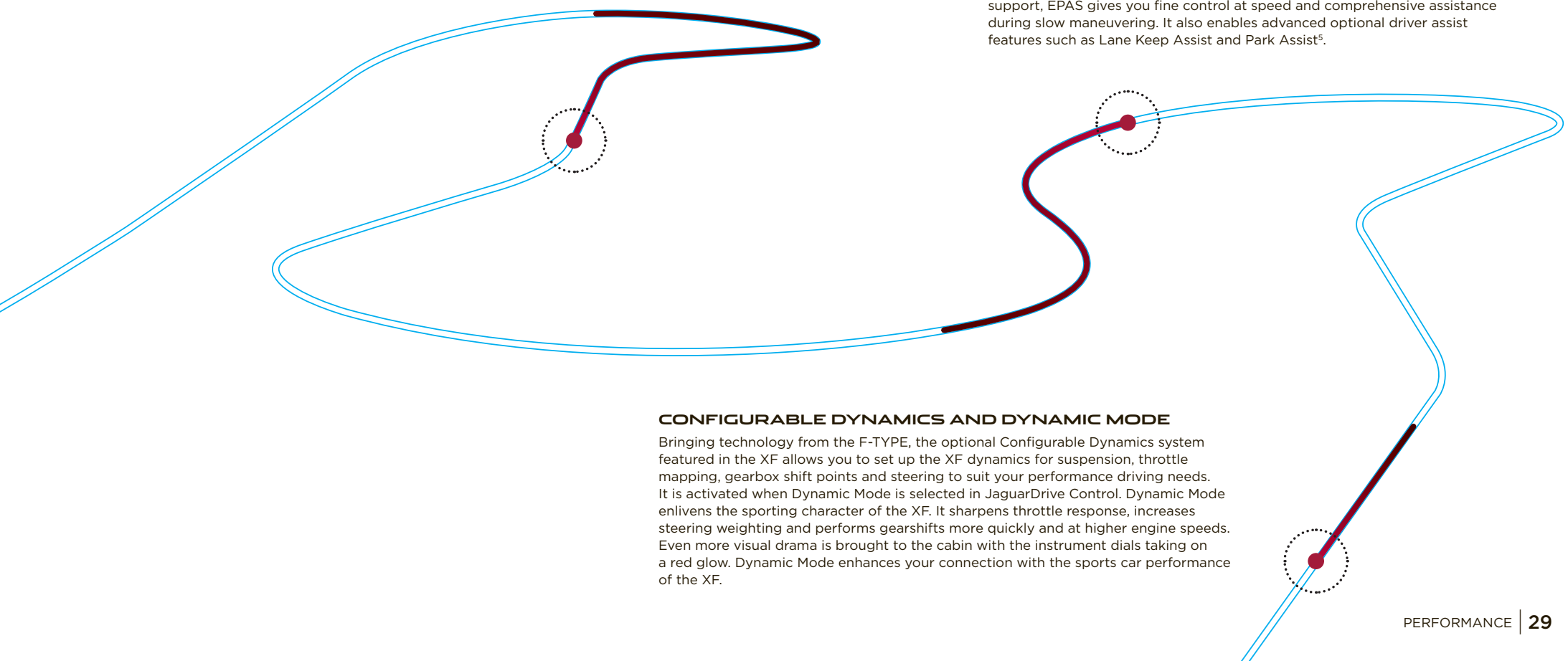

DRIVING TECHNOLOGY

ALL SURFACE PROGRESS CONTROL



ADDED DRIVER ASSISTANCE

LOW SPEED CRUISE CONTROL

All Surface Progress Control (ASPC) developed by Jaguar is a low speed cruise control that helps the XF cope with low traction situations. ASPC allows the driver to concentrate more on steering the vehicle. Once activated, you use the cruise control buttons to set a 'target' speed of between 2.2 mph and 18.6 mph. The system then works to achieve and maintain that speed while exerting traction control⁵.

ASPC is standard and gives the XF drivers added assistance over slippery, loose or icy surfaces, undulating terrain and even while descending a difficult incline. It helps make the XF easy to drive in challenging conditions. ASPC also has a pull-away function allowing the XF to progress from rest on slippery surfaces and ascending gradients, as well as a hill descent function that controls vehicle speed on steeper inclines⁵.



GRAVEL

Fitting All Season or Winter tires to the XF can improve capability on slippery surfaces. Disclaimers apply. Please see page 91 for further details.



WET GRASS



SNOW/ICE



WET ROAD



ADVANCED DRIVETRAIN TECHNOLOGY



ALL WHEEL DRIVE

ADAPTIVE SURFACE RESPONSE

The XF All Wheel Drive (AWD) system delivers confident handling on most surfaces. Developed by Jaguar, the unique Intelligent Driveline Dynamics software features sophisticated algorithms designed to react intelligently to road conditions for traction on demand. As well as offering a smoother drive, it also consumes less fuel and has lower emissions than permanent AWD. Predictive, as well as reactive, the system helps prevent you from losing traction instead of working to regain it.

Adaptive Surface response (AdSR) is fitted as standard on All Wheel Drive vehicles fitted with Adaptive Dynamics. The Adaptive Surface Response (AdSR) is designed to recognize differences between surfaces to exploit the maximum available grip. Drawing on the expertise of Jaguar Land Rover four-wheel drive systems, AdSR constantly monitors the environment and adjusts the appropriate engine and brake settings⁵. Once selected, AdSR works to support you in adverse weather and across most challenging surfaces.

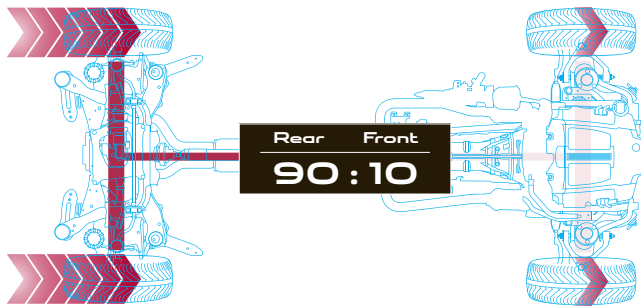

DRY ROAD SURFACES

In normal driving conditions, virtually all torque is distributed to the rear wheels providing signature Jaguar rear wheel drive performance.

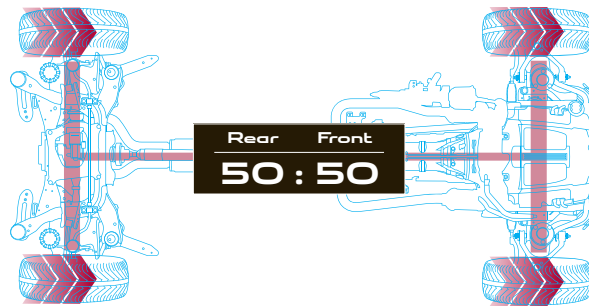

LOW TRACTION SURFACES

Winter Mode can be selected at the touch of a button to distribute torque 50:50 between front and rear wheels to maximize control in difficult conditions.

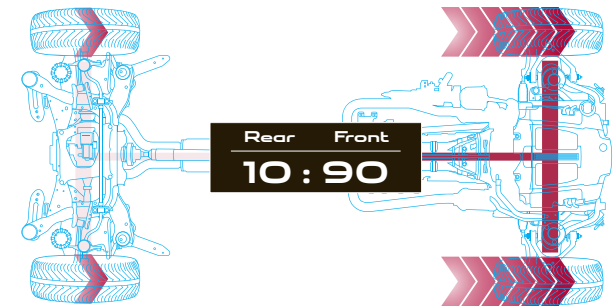

MIXED LOW TRACTION SURFACES

In conditions where the rear wheels experience a complete loss of traction, over 90 percent of engine torque can be distributed from the rear wheels to the front wheels to provide enhanced grip.

VEHICLE SHOWN: XF R-SPORT AWD IN AMMONITE GREY WITH OPTIONAL 20" STAR ALLOY WHEELS
Disclaimers apply. Please see page 91 for further details.

TORQUE VECTORING APPLIES BRAKE PRESSURE TO SLOW THE INSIDE FRONT AND INSIDE REAR WHEELS INDEPENDENTLY.

TORQUE VECTORING

MAXIMIZED CORNERING CAPABILITY

Torque Vectoring is designed to maximize capability through even the tightest corners for the XF. Torque Vectoring technology provides controlled independent braking on the individual inside front and rear wheels to add to the turning forces acting on the car. In most conditions more braking pressure is applied to the rear inside wheel as this supports the most increased cornering capability, while the front inside wheel is braked for greater effectiveness and refinement. The result is reduced understeer for sharper turning and more consistent road holding. Torque Vectoring delivers increased sports car-like agility and added driver confidence⁵.

POWER IS SUSTAINED TO MAINTAIN CONSTANT SPEED OF OUTER WHEELS.

ADDITIONAL ROTATIONAL FORCE APPLIED AROUND VEHICLE'S AXIS.

VEHICLE SHOWN: XF PRESTIGE IN RHODIUM SILVER WITH 19" RAZOR ALLOY WHEELS
Disclaimers apply. Please see page 91 for further details.





JAGUAR

XF

35t

4BS 688

STABILITY AND CONTROL



DYNAMIC STABILITY CONTROL



ENGINE DRAG TORQUE CONTROL

The stability systems keep the XF balanced whether you're driving enthusiastically or simply want some reassurance in challenging conditions.

Dynamic Stability Control (DSC) monitors the dynamic behavior of the XF, intervening to assist vehicle stability and optimizing available grip. DSC reduces engine torque and applies braking to the appropriate wheels to correct the car's direction of travel by counteracting understeer or oversteer. The XF DSC system has enhanced understeer control to reduce speed and regain control more effectively⁵.

Engine Drag Torque Control (EDC) mitigates the chance of wheel lock-up caused by strong engine braking in slippery conditions. It acts by briefly increasing torque to the wheels as appropriate.

BRAKING APPLIED TO APPROPRIATE WHEELS TO COUNTERACT UNDERSTEER/OVERSTEER

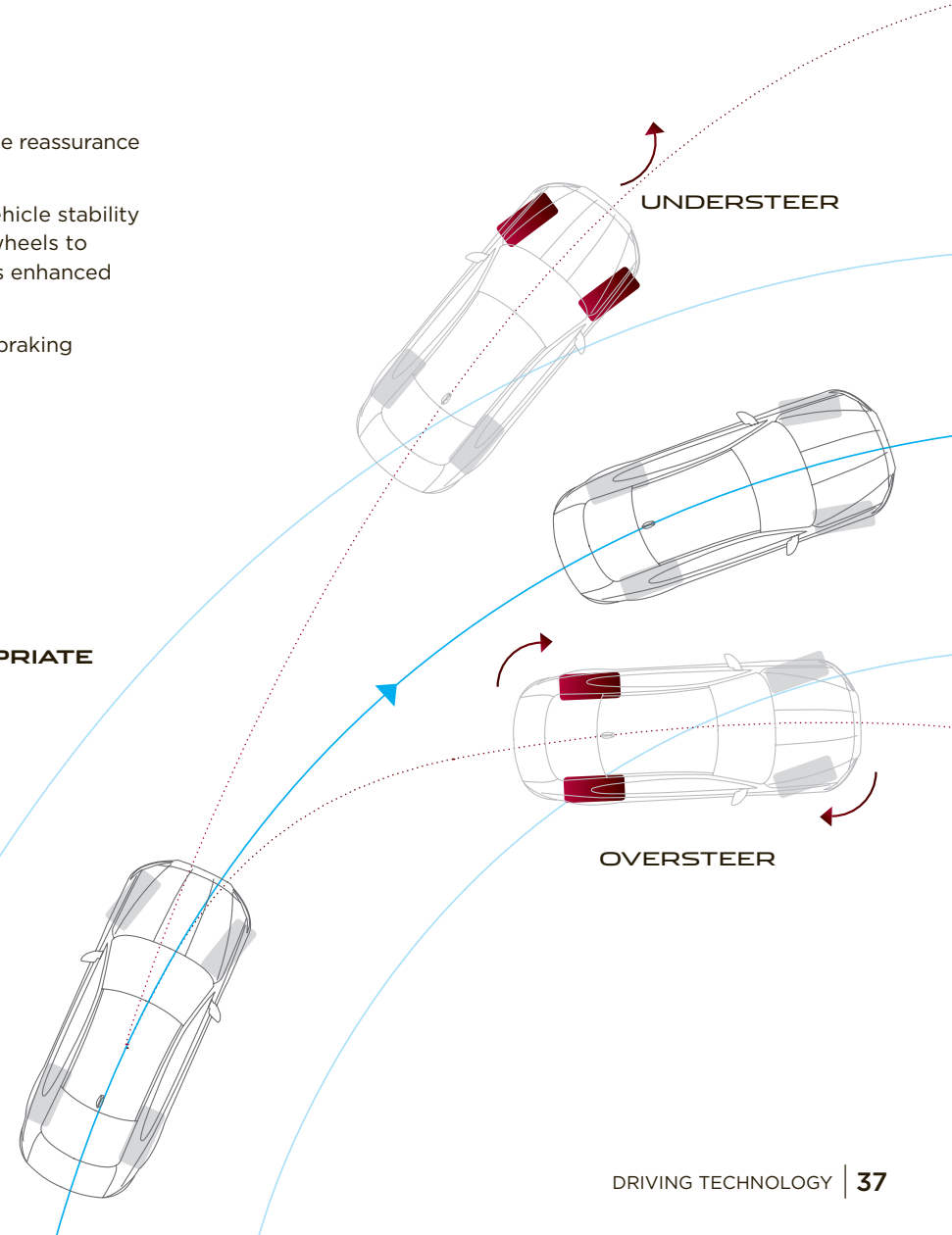

VEHICLE SHOWN: XF R-SPORT IN AMMONITE GREY
Disclaimers apply. Please see page 91 for further details.



HEAD-UP DISPLAY

> HEAD-UP DISPLAY WITH LASER TECHNOLOGY

The optional Head-Up Display (HUD) with laser technology projects key information onto the windshield. Remaining clear even in direct sunlight, the crisp, bright image can display vehicle speed, navigation, cruise control notifications and Traffic Sign Recognition data, where available. This technology helps you minimize time spent looking down at the instrument cluster and can help you maintain continuous awareness of your speed⁵.

ADAPTIVE CRUISE CONTROL WITH QUEUE ASSIST

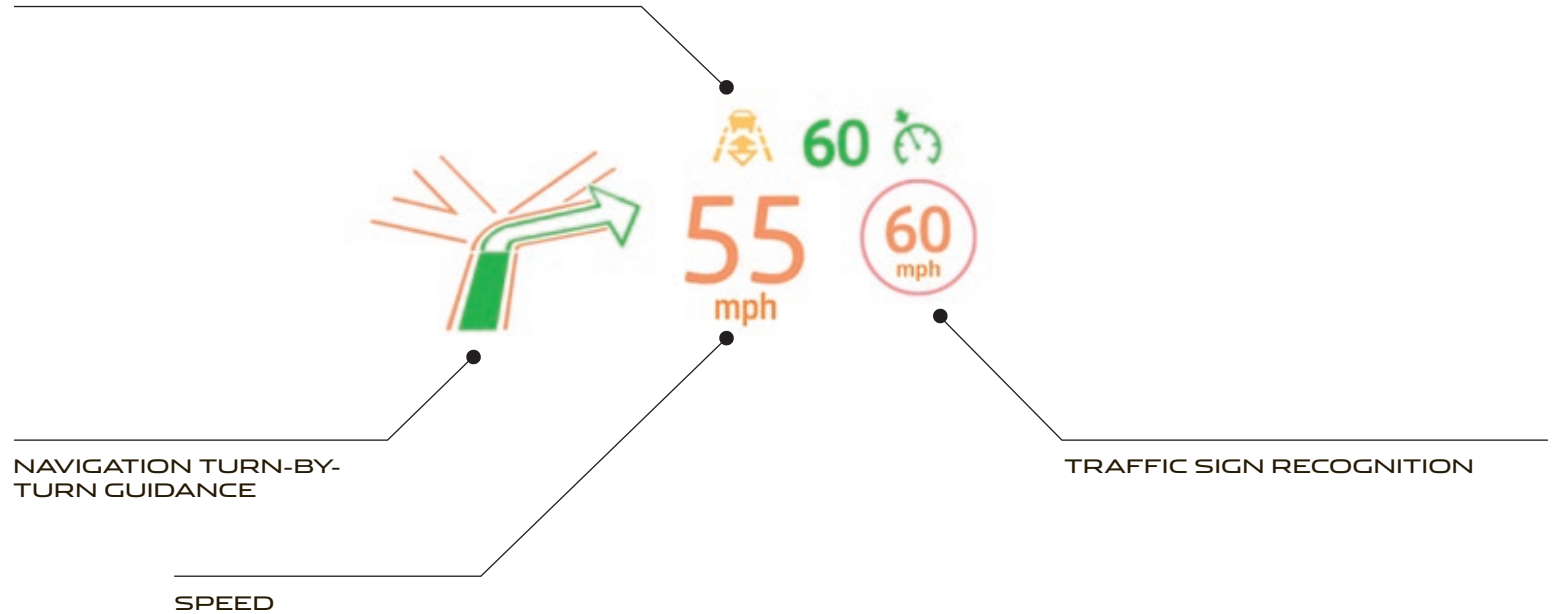

Disclaimers apply. Please see page 91 for further details.

INFOTAINMENT
JAGUAR INCONTROL® TECHNOLOGIES

 INCONTROL TOUCH™ | INCONTROL TOUCH PRO™

Jaguar InControl® is our suite of advanced technologies that links both you and your XF to the wider world. Choose from two InControl™ infotainment systems: InControl Touch™, available as standard, or upgrade to InControl Touch Pro™.

Third Party programs or applications may require an end user license from the supplier.
Do not use Jaguar InControl® features under conditions that will affect your safety or the safety of others. Driving while distracted can result in loss of vehicle control.
The Wi-Fi hotspot is intended for passenger use only. InControl® features may require an additional subscription with separate terms and conditions.



INCONTROL TOUCH™
STANDARD ON EVERY XF

8 inch Touch-screen
 5 inch instrument panel display with analog dials
 Meridian™ Sound System (380W)
 HD Digital Radio, iPod®, USB, Bluetooth® and AUX connections



InControl Remote & Protect™ consists of
 SOS Emergency Call, Jaguar Optimized Assistance,
 Stolen Vehicle Locator and Remote smartphone app

OPTIONAL FEATURES

InControl Touch™ SD Navigation
 InControl Apps™
 InControl Wi-Fi™
 SiriusXM® Satellite Radio



INCONTROL TOUCH PRO™
AVAILABLE AS AN UPGRADE

10.2 inch Touch-screen with multi-touch gestures
 and customizable homescreen
 12.3 inch instrument panel display with virtual dials
 and full screen 3D navigation map view
 InControl Touch Pro™ Solid State Drive (SSD) Enhanced Navigation
 Meridian™ Surround Sound System (825W)
 HD Digital Radio and SiriusXM® Satellite Radio, iPod®, Bluetooth®
 and 2 x USB connections
 CD/DVD Drive



InControl Remote & Protect™ consists of
 SOS Emergency Call, Jaguar Optimized Assistance,
 Stolen Vehicle Locator and Remote smartphone app

Connected Navigation consists of InControl Apps™
 and InControl Wi-Fi™



8 INCH TOUCH-SCREEN SHOWN AT ACTUAL SIZE

Audio	Meridian™ Sound System (380W)
Display	5 inch instrument panel display with analog dials
Multimedia	HD Digital Radio, iPod®, USB, Bluetooth® and AUX connections
InControl Touch™ Package	InControl Remote & Protect™ consists of SOS Emergency Call, Jaguar Optimized Assistance, Stolen Vehicle Locator and Remote smartphone app
Optional Features	InControl Touch™ SD Navigation, InControl Apps™, InControl Wi-Fi™ and SiriusXM® Satellite Radio

Do not use Jaguar InControl® features under conditions that will affect your safety or the safety of others. Driving while distracted can result in loss of vehicle control. The Wi-Fi hotspot is intended for passenger use only. InControl® features may require an additional subscription with separate terms and conditions.

INCONTROL TOUCH™



ADVANCED INFOTAINMENT AS STANDARD

The InControl Touch™ multimedia system is the hub for connectivity, control and entertainment. The key features are:

8 inch Touch-screen at the heart of the center console. Clear and responsive graphical interface for quick control. Easy to use Touch-screen responds directly to touch and swipe gestures.

Bluetooth phone connectivity allows you to link and control your smartphone via InControl Touch™ either for phone calls or music playback: simple, easy and wire-free.

Access a world of music thanks to HD Digital Radio and available SiriusXM® Satellite Radio, as well as iPod, USB and AUX connections.

Integrated text-to-voice technology reduces distraction by reading out incoming text messages. You can easily respond with short, prepared messages.

Precise climate control is available via the Touch-screen. Adjust temperature levels, direction and intensity of airflow and operate heated or cooled seats (if fitted).

InControl Remote™ is a multi-function app that allows you to monitor as well as interact with your XF from your smartphone. Remote start the engine to pre-condition the climate, lock and unlock the car, locate your XF on a map or by using the beep and flash function, and track your journeys – all via the app.

InControl Protect™ includes SOS Emergency Call and optimized Roadside Assistance, which can automatically bring the relevant services to your exact location when needed.



OPTIONAL FEATURES

Enhance the capabilities of the InControl Touch™ multimedia system by selecting from the following options:

InControl Touch™ SD Navigation makes planning journeys and following routes easy, thanks to turn-by-turn voice guidance, intersection views and 3D maps.

InControl Apps™ features a range of Jaguar approved apps that can be connected to the car from your smartphone. It ensures the safe and convenient use of these apps that have been optimized specifically to enhance aspects of your in-car experience.

InControl Wi-Fi™ gives you the option to create a 3G hotspot using the car antenna when you fit a SIM card. This strengthens your link to the outside world, for a more stable connection than an individual device could maintain. Connect up to eight devices to read emails, browse the web and download content.



Explore Jaguar InControl® at JAGUARUSA.COM

Please consult your local Jaguar Retailer for further details. Certain features require the fitment of a SIM with a suitable data contract.



10.2 INCH TOUCH-SCREEN SHOWN AT ACTUAL SIZE

Audio	Meridian™ Surround Sound System (825W)
Navigation Guidance	InControl Touch Pro™ SSD Enhanced Navigation
Display	12.3 inch instrument panel display with virtual dials and full screen 3D Map View
Multimedia	iPod®, Bluetooth®, HDMI, 2 x USB connections, and CD/DVD Drive
InControl Touch Pro™ Package	InControl Remote & Protect™ consists of SOS Emergency Call, Jaguar Optimized Assistance, Stolen Vehicle Locator and Remote smartphone app. Connected Navigation consists of InControl Apps™, InControl Wi-Fi™. Additional services include Route Planner Companion App, share your destination and ETA, Commute Mode, Arrival Mode, real time traffic information and fuel and parking services.



12.3 inch Virtual Instrument Display

Do not use Jaguar InControl® features under conditions that will affect your safety or the safety of others. Driving while distracted can result in loss of vehicle control. The Wi-Fi hotspot is intended for passenger use only. InControl® features may require an additional subscription with separate terms and conditions.

INCONTROL TOUCH PRO™

UPGRADE TO NEXT GENERATION INFOTAINMENT

The next-generation hardware and software of InControl Touch Pro™ advances your vehicle's connectivity and entertainment to the very highest level. InControl Touch Pro™ features replace or enhance those found in InControl Touch™. The key aspects of InControl Touch Pro™ are:

Larger, highly-responsive, 10.2 inch Touch-screen at the heart of the center console with customizable home screen and lightning fast response times. Its interactive side panel makes multi-tasking easy.

Pinpoint touch control allows you to manipulate and interact with information swiftly and seamlessly. The Touch-screen responds in the same manner as a smartphone or tablet computer, providing multi-touch gestures such as pinch to zoom and swipe.

12.3 inch Instrument Panel Display with Virtual Dials and full screen 3D Map View makes driving even more of a pleasure. It is housed in the instrument display directly in front of the driver. Select full screen 3D Map View or choose one of four graphical themes to suit your personal preference.

Solid State Drive Enhanced Navigation with response times that are a fraction of conventional systems'. One of the many innovative features of InControl Touch Pro™ Navigation is that it allows you to set a destination and the system alerts you if you have insufficient fuel for the journey. It then displays filling stations on the part of the route where you may be low on fuel. The system automatically displays parking options.

ENHANCED CONNECTIVITY

The services, technologies and applications found within Connected Navigation provide you with the very best in connectivity and convenience. It offers many features including:

Route Planner Companion App offers true door-to-door navigation. Pre-plan your destination and route via your Apple or Android smartphone. The app will guide you to your car, where you will find your selected route available on the car's Touch-screen. When you've completed your road journey, the app can guide you by foot or public transport (where supported) to your destination.

Share your estimated time of arrival so your selected contact(s) will know exactly when you will arrive, as calculated by the navigation guidance system. If you're running late, the system can then send automatic updates via text or email, without any further action from you.

Commute Mode allows the system to learn your commutes and automatically advises you of the expected journey time based on live and historical traffic movements. The system learns the routes you take for a given destination and then advises which of those is the quickest.

Arrival Mode displays interactive 360 degree street level imagery of your destination for seamless finishes to journeys. It automatically displays again upon your arrival. You can simply tap the Touch-screen to select a nearby parking spot, which appears as an updated destination.

 Explore Jaguar InControl® at JAGUARUSA.COM

Please consult your local Jaguar Retailer for further details. Certain features require the fitment of a SIM with a suitable data contract.

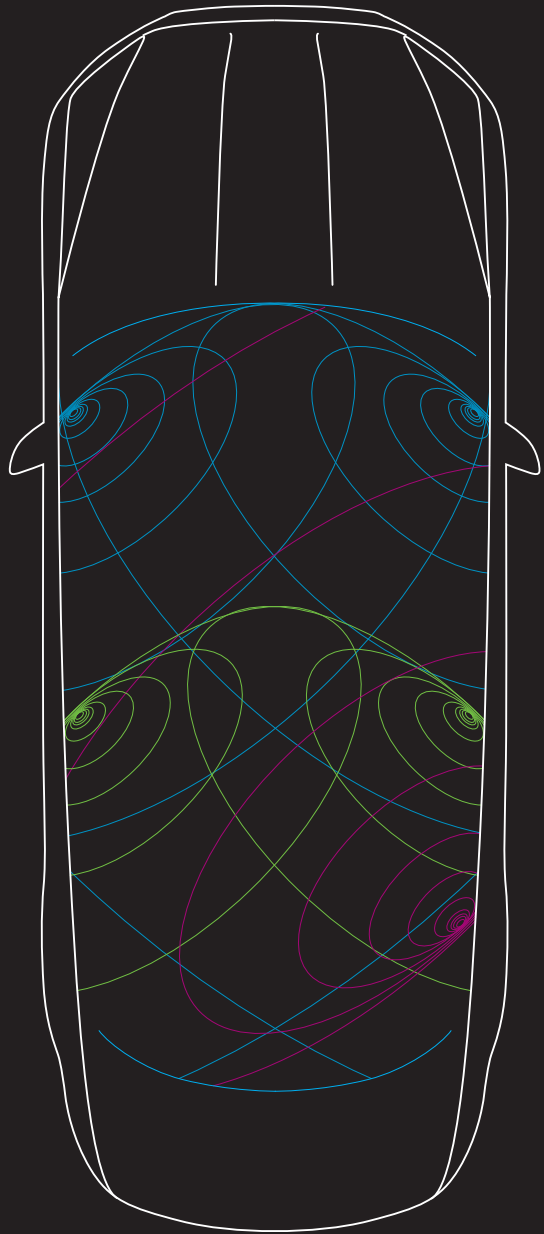

AUDIO

MERIDIAN™ SOUND SYSTEMS

The XF offers an enhanced listening experience with a choice of two Meridian Sound Systems. Designed in conjunction with the British audio experts Meridian, these systems use innovative audio technology and precise speaker placement to give perfectly optimized sound quality.

The superb Meridian 380W Sound System has 11 speakers and is standard on all XF models. The 825W Surround Sound System has 17 speakers which ensure that, wherever you or your passengers sit in XF, everyone will enjoy a rich, enveloping audio experience.



-  Fresh air subwoofer
-  Front door waves tweeter midrange bass
-  Rear door waves tweeter midrange

Diagram representative of Meridian 380W Sound System.



MERIDIAN

SOUND SYSTEM AVAILABLE IN CONJUNCTION WITH **INCONTROL TOUCH™**

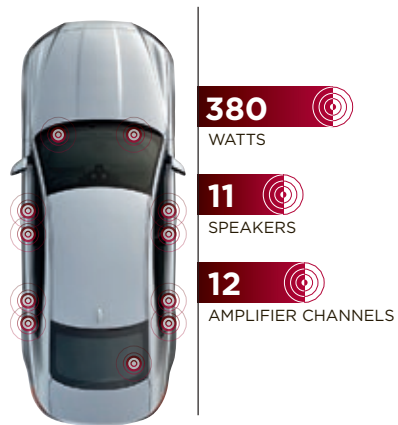

**MERIDIAN
SOUND SYSTEM**

DSP amplifier,
Dynamic Volume Control
380 watts; 11 speakers;
12 amplifier channels

SOUND SYSTEM AVAILABLE IN CONJUNCTION WITH **INCONTROL TOUCH PRO™**

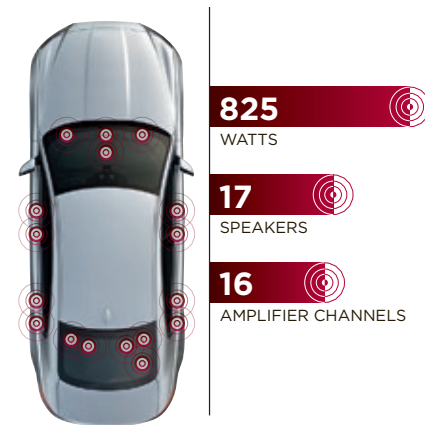

**MERIDIAN
SURROUND SOUND SYSTEM**

DSP amplifier, Audyssey MultEQ
Audio Equalization,
Dynamic Volume Control
825 watts; 17 speakers;
16 amplifier channels

ASSISTANCE AND EFFICIENCY

ADVANCED DRIVER ASSISTANCE



1 AUTONOMOUS EMERGENCY BRAKING*

Should a potential collision be detected the XF gives an audible forward collision warning. Visual warnings follow. If the driver takes no action the system is designed to apply the brakes to help reduce the severity of the possible impact, when driving below 50 mph.

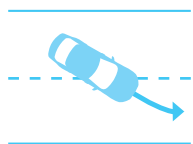

2 LANE DEPARTURE WARNING*

Lane Departure Warning notifies the driver with a visual alert and a gentle vibration of the steering wheel should the car detect an unintentional drift from its lane, helping to keep everyone on board safe.

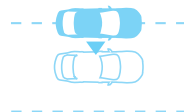

3 LANE KEEP ASSIST AND DRIVER CONDITION MONITOR*

Lane Keep Assist (LKA) senses unintentional lane drift and helps steer the XF back into its lane. Driver Condition Monitor (DCM) detects lapses in concentration due to tiredness by monitoring driver inputs and suggests taking a break via an audible alert and a visual notification in the instrument cluster.



4 TRAFFIC SIGN RECOGNITION WITH ADAPTIVE SPEED LIMITER*

Traffic Sign Recognition (TSR) technology detects speed limits, including variable limits, and no passing signs via the forward-facing camera, then displays them to the driver. The Adaptive Speed Limiter uses TSR's information, supported by map data from the navigation system, to help keep the XF within the appropriate speed limit.



5 BLIND SPOT MONITOR AND REVERSE TRAFFIC DETECTION*

Blind Spot Monitor alerts you to vehicles or obstacles beside the XF, as well as ones approaching from a distance behind, via an icon displayed in the appropriate exterior mirror. Reverse Traffic Detection extends the Blind Spot Monitor function and alerts you via the Touch-screen of moving vehicles during reversing - for example, when leaving a parking space with restricted vision.



6 PARK ASSIST*

Park Assist makes parking in tight spaces easier than ever. The XF can accurately steer itself during both parallel and perpendicular parking maneuvers - the driver only has to control the brakes and accelerator. An exit-assist function can help guide the XF while leaving a parallel space.

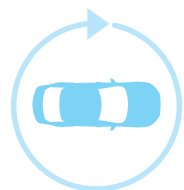

7 SURROUND CAMERA SYSTEM*

Surround Camera System gives you 360° exterior vision on the Touch-screen. This helps with various maneuvers from parking by a curb to getting in and out of tight spaces.

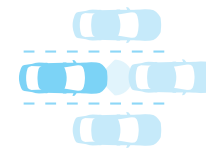

8 ADAPTIVE CRUISE CONTROL WITH QUEUE ASSIST*

Adaptive Cruise Control uses radar technology to automatically adjust your speed to maintain a set distance from the vehicle ahead. If that vehicle slows, your XF reduces its speed to maintain a set distance. The XF resumes its pre-set speed as soon as the road in front is clear. Should the car in front stop completely, the Queue Assist function brings the XF to a smooth halt. Once the traffic moves off, touch the accelerator and the XF will follow the car in front again.

*Optional feature.

These features are not a substitute for driving safely with due care and attention and will not function under all circumstances, speeds, weather and road conditions, etc. Driver should not assume that these features will correct errors of judgment in driving. Please consult the owner's manual or your local Jaguar Retailer for more details.

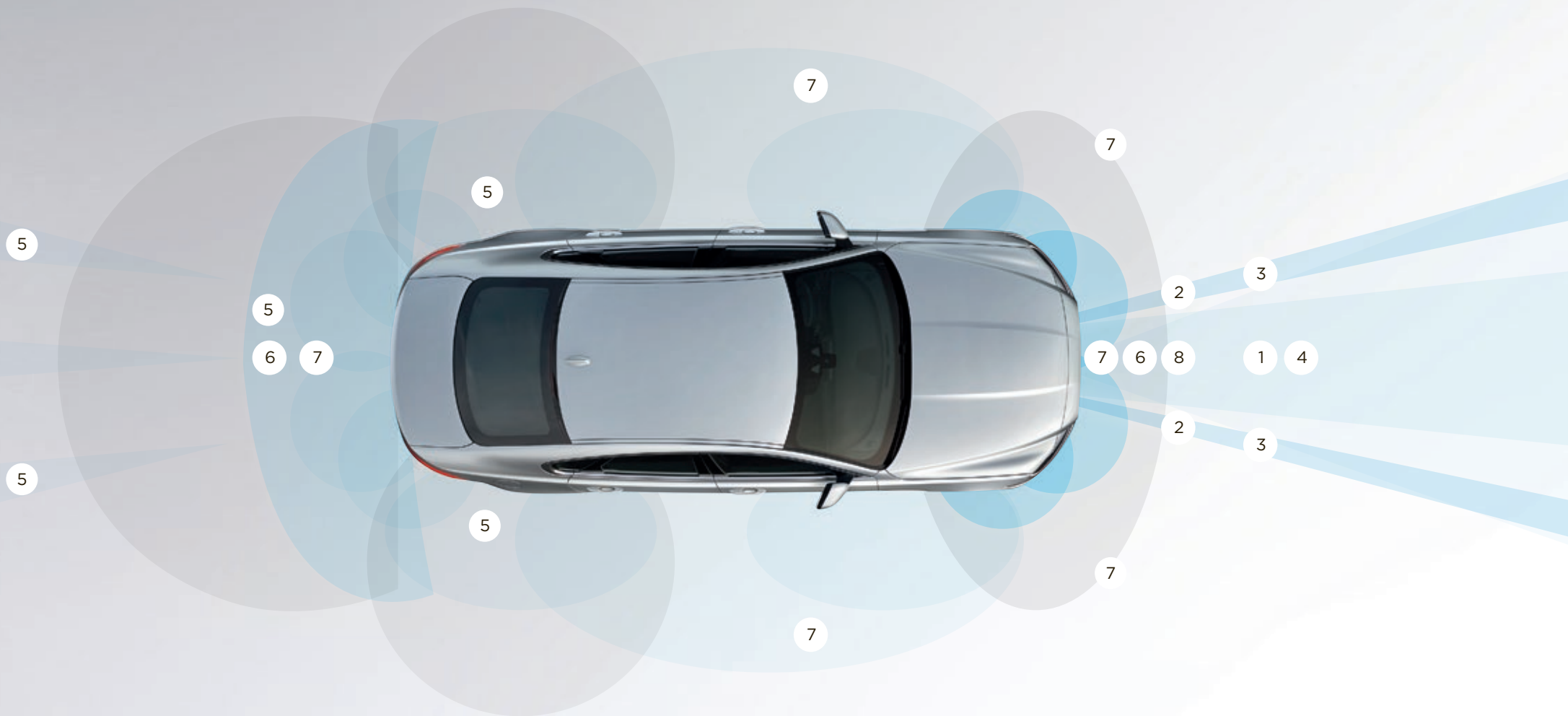

VEHICLE SHOWN: XF PRESTIGE IN RHODIUM SILVER

EFFICIENT TECHNOLOGIES

 **STOP/START TECHNOLOGY** | **CLEAN TECHNOLOGIES**

Everyone wants to do more with less. That is why the XF uses a range of technologies to reduce fuel consumption and CO₂ emissions, all while staying true to the dynamic nature of Jaguar.



STOP/START TECHNOLOGY

The XF engines come with Stop/Start. It shuts down the engine when you come to a complete halt and restarts the engine immediately when required. The new system helps save fuel, especially during city driving.



ELECTRIC POWER ASSISTED STEERING (EPAS)

The next generation Electric Power Assisted Steering (EPAS) offers outstanding feedback, control and immediate power assistance. Electrically driven, it's only active on demand which saves fuel.



ADVANCED AERODYNAMICS

The XF offers low drag co-efficient of 0.29. This helps the XF cut through the air with ease, meaning less work for the engine and therefore reduced fuel consumption and emissions.



LOW FRICTION TECHNOLOGIES

Technologies such as smart coatings on the pistons and needle roller bearings in the Ingenium range help to reduce friction, particularly at low engine temperatures. This helps the car perform at its efficient best.

PERSONALIZATION THE XF - YOUR CHOICE

 Configure your vehicle at JAGUARUSA.COM



CHOOSE YOUR ENGINE

Page 54

Select your XF engine,
to suit your driving style.

CHOOSE YOUR MODEL & PACKAGES

Page 56

Compare the wealth of standard
features and options on the XF models.

CHOOSE YOUR COLOR

Page 64

Express your individuality with
one of the stunning exterior colors
available on the XF.

CHOOSE YOUR WHEELS

Page 66

Add the personal finishing touch to your new XF, and complement its stunning style with a set of beautifully designed alloy wheels.

CHOOSE YOUR INTERIOR

Page 68

There's a wide selection of premium materials, leathers, veneers and finishes for every personal taste.

CHOOSE YOUR JAGUAR ACCESSORIES

Page 80

Really make it yours by adding style, practicality and versatility with official XF Accessories from your local Jaguar Retailer.

1 CHOOSE YOUR ENGINE

 Configure your vehicle at JAGUARUSA.COM

ENGINES: RWD

3.0 LITER V6

SUPERCHARGED GAS

MAXIMUM POWER 340HP
MAXIMUM TORQUE 332 lb-ft
ACCELERATION 0-60 mph 5.2 seconds
TOP SPEED 121 mph
COMBINED MPG 24*
PREMIUM, PRESTIGE, R-SPORT

3.0 LITER V6

SUPERCHARGED GAS

MAXIMUM POWER 380HP
MAXIMUM TORQUE 332 lb-ft
ACCELERATION 0-60 mph 5.1 seconds
TOP SPEED 121 mph
COMBINED MPG 24*
S

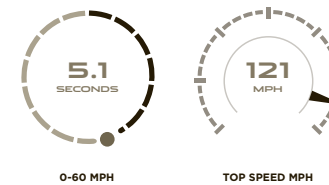
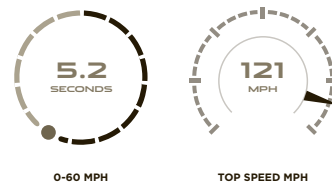

*All figures are EPA estimates. Actual mileage may vary.

Always follow local speed limits.

➤ ENGINES: AWD

3.0 LITER V6

SUPERCHARGED GAS

MAXIMUM POWER 340HP

MAXIMUM TORQUE 332 lb-ft

ACCELERATION 0-60 mph 5.1 seconds

TOP SPEED 121 mph

COMBINED MPG 23*

PREMIUM, PRESTIGE, R-SPORT

3.0 LITER V6

SUPERCHARGED GAS

MAXIMUM POWER 380HP

MAXIMUM TORQUE 332 lb-ft

ACCELERATION 0-60 mph 5.0 seconds

TOP SPEED 121 mph

COMBINED MPG 23*

S



0-60 MPH

TOP SPEED MPH



0-60 MPH

TOP SPEED MPH

2 CHOOSE YOUR MODEL & PACKAGES

 Configure your vehicle at JAGUARUSA.COM

LUXURY



PREMIUM

KEY FEATURES

- 18" alloy wheels
- Bi-function Xenon headlamps with LED J-Blade and powerwash
- Luxtec seats
- 10-way front seat (8-way electric)
- Gloss Black veneer
- Morse Code Aluminum instrument panel finisher
- All Surface Progress Control
- Electric glass opening moonroof
- Meridian 380W sound system



PRESTIGE

KEY FEATURES (IN ADDITION TO PREMIUM)

- 19" alloy wheels
- Taurus leather seats
- Soft grain leather steering wheel
- Heated front seats with 4-way power lumbar
- Interior Mood Lighting
- Keyless entry
- Front and rear parking aids
- Navigation system

> SPORT



R-SPORT

KEY FEATURES (IN ADDITION TO PRESTIGE)

- 'R-Sport' body kit including sports front bumper, side sills and trunk mounted spoiler
- Sports Taurus leather seats
- Metal tread plates and multi-function steering wheel with 'R-Sport' branding
- Gloss Black side window surround
- Dark Morse Code Aluminum instrument panel finisher
- LED headlamps with Intelligent High Beams
- Lane Keep Assist with Driver Condition Monitor
- Blind Spot Monitor with Reverse Traffic Detection



S

KEY FEATURES (IN ADDITION TO R-SPORT)

- 20" alloy wheels
- 'S' body kit including sports front bumper, Gloss Black side sills, rear valance and trunk mounted spoiler
- Red Brake Calipers
- 14-way front seats (12-way electric)
- Sports Taurus Leather 'S' embossed seats
- Grey Figured Ebony veneer
- Dark Hex Aluminum instrument panel finisher
- Metal tread plates and multi-function steering wheel with 'S' branding
- Adaptive Dynamics

2 CHOOSE YOUR MODEL & PACKAGES

 Configure your vehicle at JAGUARUSA.COM

KEY STANDARD & OPTIONAL FEATURES

	PREMIUM	PRESTIGE	R-SPORT	S
TRANSMISSION, STEERING & DYNAMIC FEATURES				
8-Speed ZF electronic automatic transmission	●	●	●	●
Power-assisted, speed sensitive, variable ratio, rack and pinion steering	●	●	●	●
Electric Power-Assist Power Steering (EPAS) ⁵	●	●	●	●
Torque Vectoring	●	●	●	●
Hill Launch Assist ⁵	●	●	●	●
All Surface Progress Control (ASPC) ⁵	●	●	●	●
Steering wheel mounted shift paddles	●	●	●	●
JaguarDrive Control™				
Normal, Eco & Dynamic Modes ⁵	●	●	●	●
Winter Mode ⁵	●	●	●	● RWD
Adaptive Surface Response (AdSR) Mode ⁵ (AWD model only)	—	—	—	● AWD
JaguarDrive Selector™ rotary gear selector	●	●	●	●
SUSPENSION				
Four-wheel independent suspension	●	●	●	●
Double wishbone front suspension architecture	●	●	●	●
Integral link rear suspension	●	●	●	●
Adaptive dynamics	—	○	○	●
BRAKES & STABILITY CONTROL				
Anti-Lock Braking System (ABS) ⁵	●	●	●	●
Cornering brake control (CBC) ⁵	●	●	●	●
Dynamic Stability Control (DSC) with Trac DSC mode ⁵	●	●	●	●
Electric Parking Brake (EPB) with drive away release	●	●	●	●
Hazard lights under heavy braking	●	●	●	●

SAFETY & SECURITY

	PREMIUM	PRESTIGE	R-SPORT	S
SAFETY				
Passive front head restraints (whiplash reduction system)	●	●	●	●
Belt-minder system with audio reminder chime and flashing warning light engages if vehicle is moving more than 10 mph (16 KM/H) and safety belt is not buckled on occupied front or rear seats	●	●	●	●
Driver and Front passenger safety belt pretensioners	●	●	●	●
ISOFIX Child seat tethered-anchorage	●	●	●	●
Dual-stage front airbags and seat-mounted side airbags for front occupants ⁶	●	●	●	●
Full length side-impact curtain airbags ⁶ for front and rear	●	●	●	●
Three-point restraints at all seating positions	●	●	●	●
Tire Pressure Monitoring System (TPMS)	●	●	●	●
SECURITY				
Antitheft engine immobilizer	●	●	●	●
Driveaway locking	●	●	●	●
Security system with perimeter alarm	●	●	●	●
Emergency phosphorescent release in trunk	●	●	●	●
Brake pad wear indicator	●	●	●	●
Hazard lights under heavy braking	●	●	●	●
LOCKING				
2-stage unlock, Touch screen programmable	●	●	●	●
Central locking with drive-away door locking (touch screen programmable)	●	●	●	●
Jaguar Smart Key System™ with emergency blade - provide remote locking/unlocking, access to trunk and activate panic alarm	●	●	●	●
Keyless entry	—	●	●	●
Soft Door Close	—	P3	P3	P3
Trunk lid - Power open/close (with safety sensing)	—	P3	P3	P3
Power operated child locks	●	●	●	●
Global window close from exterior lock button	●	●	●	●
Valet function for glove box and trunk security	●	●	●	●

● Standard ○ Option — Not available

P1 Cold Climate Package P2 Vision Package P3 Comfort & Convenience Package P4 Luxury Interior Upgrade Package P5 Driver Assistance Package P6 Technology Package P7 Black Package

Disclaimers apply. Please see page 91 for further details.

DRIVERS AIDS⁵

	PREMIUM	PRESTIGE	R-SPORT	S
Cruise control	●	●	●	●
Automatic Speed Limiter (ASL) ⁵	●	●	●	●
Blind Spot Monitor with Closing Vehicle Sensing	P2	P2	●	●
Rear cross traffic detection alert ⁵	P2	P2	●	●
Rear camera ⁵ parking aid with guidance lines on display	●	●	●	●
Rear parking sensors with Touch-screen visual indicators	P2	●	●	●
Front parking sensors with Touch-screen visual indicators	P2	●	●	●
Proximity Camera system ⁵	—	—	P5	P5
Park Assist ⁵ - Parallel & Perpendicular Parking plus Parking Exit	—	—	P5	P5
360° Park Distance Control	—	—	P5	P5
Traffic Sign Recognition & Intelligent Speed Limiter (ISL) ⁵	—	—	P5	P5
Adaptive Cruise Control (ACC) with Forward Alert, Queue Assist, Intelligent Emergency ⁵	—	—	P5	P5
Autonomous Emergency Braking	—	—	●	●
Lane Keeping Assist ⁵	—	—	●	●
Driver Condition Monitoring	—	—	●	●
Head-up Display	—	○	○	○

CONVENIENCE FEATURES

	PREMIUM	PRESTIGE	R-SPORT	S
Approach illumination	●	●	●	●
Dual function trip computer in Driver message center	●	●	●	●
Outside temperature gauge	●	●	●	●
Glove box, lockable with A/C duct for cooling	●	●	●	●
Homelink System* - compatible three-channel garage-door/entry-gate opener	●	●	●	●
Keyless push button start	●	●	●	●
Rain-sensing, variable intermittent dual wipers	●	●	●	●
Shopping bag hook and luggage tie downs in trunk	●	●	●	●
Sunglasses Holder in Overhead Console	●	●	●	●
Twin front cup holders plus auxiliary power socket in center console	●	●	●	●
Twin rear cup holders	●	●	●	●
12V Power sockets - located in rear center arm rest and in right hand trunk wall	●	●	●	●

2 CHOOSE YOUR MODEL & PACKAGES

 Configure your vehicle at JAGUARUSA.COM

EXTERIOR FEATURES

		PREMIUM	PRESTIGE	R-SPORT	S
BODY EXTERIOR APPEARANCE					
Bumpers - Body colored		●	●	●	●
Exhaust tips - Dual bright		●	●	●	●
Front Grille	Grained black mesh insert with bright chrome surround	●	●	—	—
	Grained black mesh insert with satin chrome surround	—	—	●	—
	Gloss black mesh insert with satin chrome surround	—	—	P5	●
	Gloss black mesh insert with chrome surround	—	—	—	—
Window Surround Finishers	Gloss black mesh insert with gloss black surround	—	—	—	P7
	Bright Chrome	●	●	—	—
	Gloss Black	—	—	●	●
Trunk Plinth Finisher	Bright Chrome	●	●	—	—
	Satin Chrome	—	—	●	●
Side Power Vents	Gloss black	—	—	—	P7
	Bright Chrome	●	●	—	—
	Satin Chrome	—	—	●	●
Front Bumper	Gloss black	—	—	—	P7
	R-Sport style Front Bumper	—	—	●	—
	"S" Style bumper	—	—	—	●
Side Sills	Body colored	—	—	●	—
	Gloss Black	—	—	—	●
Rear Valance	Grained Black	●	●	●	—
	Gloss Black	—	—	—	●
Rear Spoiler - Body colored, trunk mounted		—	—	●	●

EXTERIOR BADGING

		PREMIUM	PRESTIGE	R-SPORT	S
Trunk left side - Nameplate		●	●	●	●
Center trunk lid - Jaguar and leaper wordmark		●	●	●	●
Trunk Right Side	Powertrain Badging "35t"	●	●	●	—
	"S" badging	—	—	—	●
	"AWD badging" w/ AWD models only	●	●	●	●
Side Power Vents - "R-Sport"		—	—	●	—
Front grille - "S" Script		—	—	—	●

BRAKE CALIPERS

Red with "Jaguar" script (word is all silver)	—	—	—	●
---	---	---	---	---

ELECTRIC GLASS MOONROOF

Electric with tilt/slide one touch operation and electric blind	●	●	●	●
---	---	---	---	---

LAMPS

Bi-function HID Xenon headlamps with auto-leveling and auto on/off	●	●	—	—
Full LED Headlamps	P2	P2	●	●
LED Signature "J" blades daytime running lamps (turn off when Park or reverse modes)	●	●	●	●
Headlamp powerwash	●	●	●	●
Adaptive front lighting (The swivel beam angle is 15° outboard and 8° inboard)	P2	P2	●	●
Cornering Lamps	P2	P2	●	●
Intelligent high beam	P2	P2	●	●
Partial Light Emitting Diode (LED) tail lamps	●	●	●	●

MIRRORS & WINDOWS

Exterior mirrors - body color, powerfolding, electrically adjustable, heated, electrochromic with puddle lamps and clear side turn indicators	●	●	●	●
Passenger side exterior mirror - dip in reverse	●	●	●	●

● Standard ○ Option — Not available

P1 Cold Climate Package P2 Vision Package P3 Comfort & Convenience Package P4 Luxury Interior Upgrade Package P5 Driver Assistance Package P6 Technology Package P7 Black Package

INTERIOR FEATURES

	PREMIUM	PRESTIGE	R-SPORT	S
CLIMATE CONTROL				
Front deployable side vents	●	●	●	●
Automatic A/C with solar sensing, mist sensing, air filtration and dual temperature control for driver and front passenger	●	●	●	●
4-Zone Air conditioning with air ducts in glove box	—	—	P4	P4
DOOR SILL FINISHERS				
Metal with Jaguar lettering	●	●	—	—
Metal with "R-Sport" script	—	—	●	—
Metal with "S" script	—	—	—	●
Illuminated - Metal with Jaguar lettering	—	—	P4	P4
FOOTWELL RUGS				
Front and rear carpet mats with overlock edge	●	●	●	●
Premium front and rear floor mats (with nubuck edge and tonal twin needle stitching)	—	—	P4	P4
GEAR SELECTOR				
JaguarDrive™ Rotary Gear Selector - bright chrome finish	●	●	●	●
INTERIOR LIGHTING				
Overhead light console with JaguarSense™ control	●	●	●	●
Switchgear & Instrument Cluster lighting, front & rear map lights, front footwell lights, trunk illumination and front & rear downlighters	●	●	●	●
Driver and front passenger Sun visors with illuminated vanity mirrors	●	●	●	●
Blue halo illumination on Front & rear door signature lines and front & rear door release	—	●	●	●
Glovebox illumination	—	●	●	●
Front and rear puddle lamp & rear footwell lighting	—	—	P4	P4
10 colors selectable variable illumination including door storage, console and instrument panel plus rear footwells illumination and front & rear puddle lamps	—	—	P4	P4
MIRRORS & WINDOWS				
Auto-dimming interior rear view mirror	●	●	●	●
Front and rear electric windows with one-touch open/close and anti-trap	●	●	●	●
Acoustic Layer windshield	●	●	●	●
Infra red reflective front windshield glass	●	●	●	●
Heated rear window	●	●	●	●
Heated front windshield - heated with timer. Includes Heated winscreen jets	P1	○	○	○

WINDOW SUNBLINDS

	PREMIUM	PRESTIGE	R-SPORT	S
Electric rear window sunblind	—	—	P4	P4
Manual rear side window blinds	—	—	P4	P4

SEATING

10x10 way Front seats with 8x8 electric movement - Fore/Aft (2), Cushion Height (2) & Tilt (2), Squab Recline (2) - plus manual Headrest Height (2)	●	●	●	●
14x14 way Front seats with 12x12 electric movements - Fore/Aft (2), Cushion Height (2), Cushion Tilt (2) & Extension (2), Squab Recline (2), Bolster (2) plus manual Headrest Height (2)	—	—	—	●
Front Seats 4-Way power lumbar	—	●	●	●
Sport-style front seats	—	—	●	●
3-stage heated front seats	P1	●	●	●
3-stage active ventilated heated and cooled front seats	—	P3	P3	P3
3-stage heated rear seats	P1	P3	P3	P3
Memory function with 3 settings for driver seat, exterior mirrors and steering wheel column	●	●	●	●
Front Passenger seat memory	—	—	—	●
Rear-folding seat (40/20/40 split)	●	●	●	●
Rear armrest with twin cupholders	●	●	●	●

STEERING WHEEL & CONTROLS

Grained leather steering wheel with Jaguar Sequential Shift™ paddles and remote controls for audio, cruise control & Bluetooth® wireless technology	●	—	—	—
Softgrain leather steering wheel with Jaguar Sequential Shift™ paddles and remote controls for audio, cruise control, Bluetooth® wireless technology and JaguarVoice™	P1	●	●	●
Heated steering wheel	P1	●	●	●
"R-Sport" Script on Steering wheel	—	—	●	—
"S" Script on Steering wheel	—	—	—	●
Power Adjustable Steering Column (reach and rake)	●	●	●	●
Three flash lane change/turn indicator	●	●	●	●

2 CHOOSE YOUR MODEL & PACKAGES

 Configure your vehicle at JAGUARUSA.COM

INTERIOR FEATURES CONTINUED

	PREMIUM	PRESTIGE	R-SPORT	S
INTERIOR TRIM				
Front center console with storage compartment, auxiliary power socket, 3.5 mm stereo auxiliary input socket and armrest	●	●	●	●
Luxtec seat trim	●	—	—	—
Taurus leather seat trim	—	●	●	●
Leatherette-wrapped instrument panel	●	●	●	●
"S" embossing on front seats	—	—	—	●
Seat back map pocket - Net	—	●	●	●
Morzine Headliner	●	●	●	●
Suede cloth Premium headliner	—	—	P4	P4
INSTRUMENT PANEL FINISHERS				
Morse Code Aluminum	●	●	—	—
Dark Morse Code Aluminum	—	—	●	—
Dark Hex Aluminum	—	—	—	●
VENEER TRIM				
Gloss Black Finish	●	●	●	—
Grey Figured Ebony	—	—	—	●
Gloss Burl Walnut	—	○	○	—
Gloss Figured Ebony	—	—	—	○
Satin Ash Burl	—	—	○	—
Satin Fine Line	—	—	—	○
Carbon Fiber	—	—	○	○

INFORMATION, COMMUNICATION AND ENTERTAINMENT

	PREMIUM	PRESTIGE	R-SPORT	S
MULTIMEDIA				
Physical dials with 5" full color TFT-LCD display	●	●	●	●
Full TFT / LCD Instrument Cluster	—	P6	P6	P6
InControl Touch™ 8" capacitive Touch-screen display with controls for audio, climate control, Bluetooth® telephone connectivity and navigation if fitted ¹	●	●	●	●
InControl Touch Pro™ 10.2" capacitive Touch-screen display with controls for audio, climate control, Bluetooth® telephone connectivity and navigation ¹	—	P6	P6	P6
ECO HMI - Includes Eco data analysis, Parasitic load monitor and Driver Eco rating	●	●	●	●
Meridian 380W Sound System with 11 speakers incl 1 sub woofer	●	●	●	●
Meridian 825W 7.1 Channel Digital Surround Sound System plus Meridian Trifield mode, 17 speakers including 1 Sub-Woofer, separate DSP, Audyssey MultEQ and Meridian Cabin correction	—	P6	P6	P6
Dynamic volume Control	●	●	●	●
HD radio	●	●	●	●
Front media interface (USB & iPod®)	●	●	●	●
SiriusXM® Satellite Radio (includes 3 mo. complimentary subscription)	○	○	●	●
Jaguar InControl Apps™ enables use of optimized 3 rd party smartphone apps installed on a phone through the vehicle's touch screen	○	●	●	●
NAVIGATION				
Navigation system with SD Card-based mapping and voice control ²	○	●	●	●
InControl Touch Pro™ - Navigation system with 60GB Solid State Disk (SSD) Drive-based mapping. Includes HDD-based "virtual multichanger" and single slot in dash CD/DVD player ¹	—	P6	P6	P6
Bluetooth® wireless technology for cell phone and audio streaming	●	●	●	●
TELEMATICS				
InControl Protect™ - SOS emergency call, Jaguar Assistance Call and Stolen vehicle locator. Service complimentary for 5 years	●	●	●	●
InControl Remote™ - Smart phone application for vehicle status (fuel level, security status, last parked, direction to vehicle), vehicle lock/unlock, A/C remote setting through engine start. Feature complimentary for 5 years	●	●	●	●
InControl WiFi™ - 3G hotspot - includes 3GB or 3 months (which ever comes first) complimentary data subscription ³	○	○	○	○

● Standard ○ Option — Not available NCO No cost option

P1 Cold Climate Package P2 Vision Package P3 Comfort & Convenience Package P4 Luxury Interior Upgrade Package P5 Driver Assistance Package P6 Technology Package P7 Black Package

Disclaimers apply. Please see page 91 for further details.

OPTION PACKAGES

		PREMIUM	PRESTIGE	R-SPORT	S	
	CODE					DESCRIPTION
Cold Climate Package	Z88D	○	—	—	—	Heated Front Seats, Heated Rear Seats, Heated Steering Wheel, Heated Front Windshield with heated washer jets
Vision Package ⁵	Z86A	○	○	—	—	LED Headlamps with signature daytime running lights, Adaptive front lighting with intelligent High Beam, Blind Spot monitor with closing vehicle sensing and Reverse Traffic detection. On Premium derivative, pack also includes Front and Rear Parking aids
Comfort & Convenience Package	Z28C	—	○	○	○	Cooled Front seats, Heated Rear Seats, Soft door close, Trunk - Power open/close w/proximity safety sensing
Luxury Interior Upgrade Package	Z61V	—	—	○	○	Electric rear sunblind, Rear side window blinds, manual, 4 zone climate control (inc B-pillar vents & ducts in glove box), Suedecloth premium headliner, Ambient lighting upgrade including 10 colors variable illumination, Illuminated Sill finishers - Metal - with Jaguar lettering
Driver Assistance Package ⁵	Z68X	—	—	○	○	Adaptive Cruise Control (ACC) with Forward Alert, Advanced Emergency Brake Assist with Queue Assist, & Intelligent Emergency Brake, Proximity Camera System, Traffic Sign Recognition & Intelligent Speed Limiter, Park Assist - Parallel, Perpendicular & Parallel Exit
Technology Package ¹	Z80U	—	○	○	○	InControl Touch Pro™ - SSD based Navigation with 60GB memory and single slot in dash CD/DVD player, 10" Capacitive Touch-Screen, Full TFT/LCD Virtual Instrument Cluster and Meridian 825W Surround Sound System. (Late availability)
Black Package	Z93L	—	—	—	○	Radiator grille - Gloss Black insert with Gloss Black surround, Gloss Black Side Power Vents, Gloss Black Trunk Finisher

STAND ALONE OPTIONS

Heated front windshield	D96A	○	○	○	○	—
InControl Touch™ - Navigation system ² with SD Card-based mapping	G61C	○	—	—	—	—
Head up Display ⁵	G62A	—	○	○	○	Refer to page 38
SiriusXM® Satellite Radio ³ (includes 3 month complimentary service)	B51D	○	○	—	—	—
InControl Wi-Fi™ ³ with 3GB or 3 month complimentary data plan (which ever comes first)	A44A	○	○	○	○	Refer to page 43
Adaptive dynamics with Configurable dynamics ⁵	C35A	—	○	○	—	Refer to page 29
Powertrain "35t" debadging	B05H	NCO	NCO	NCO	—	—

3 CHOOSE YOUR COLOR



Configure your vehicle at [JAGUARUSA.COM](https://www.jaguarusa.com)

SOLID

Polaris White

Ebony Black

METALLIC

Glacier White

Ultimate Black

Rhodium Silver

Ammonite Grey

Dark Sapphire Blue

British Racing Green

Italian Racing Red

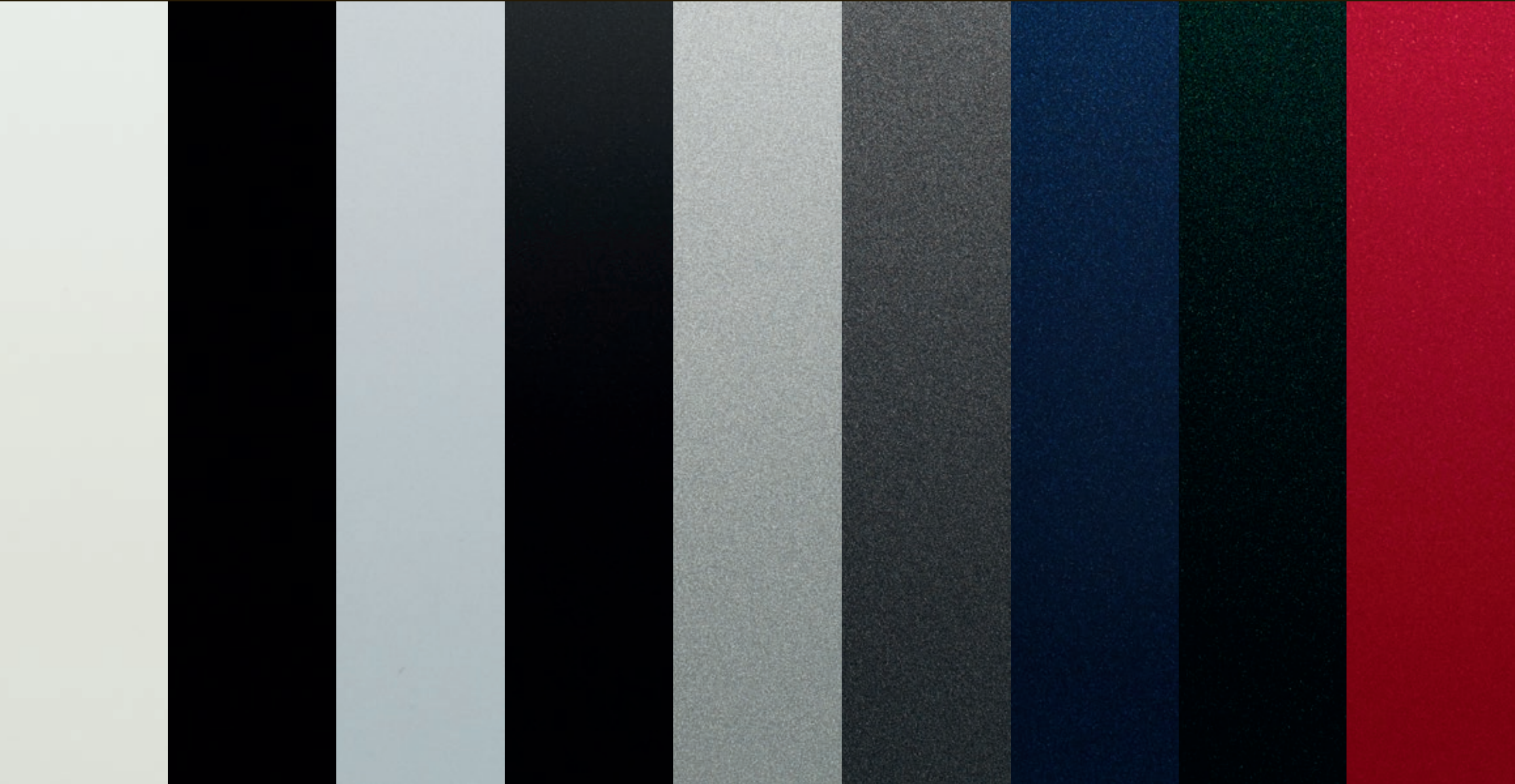

PREMIUM PALETTE

Quartzite

Odyssey Red

Aurora Red

Storm Grey

Black Berry

Tempest Grey

Celestial Black

Ingot



4 CHOOSE YOUR WHEELS

 Configure your vehicle at JAGUARUSA.COM



18" CHALICE
7 TWIN SPOKE

19" RAZOR
7 TWIN SPOKE

ALLOY WHEEL FINISH	Sparkle Silver	Sparkle Silver
ALLOY WHEEL/SIZE	8.0J x 18"	8.0J x 19"
TIRE SIZE	245/45 R18	245/40 R19
CODE	C53S	C53U
Premium	●	—
Prestige	—	●
R-Sport	—	—
S	—	—



19" VORTEX
10 SPOKE

19" AXIS
14 SPOKE

ALLOY WHEEL FINISH	Sparkle Silver	Contrast/Diamond Turned
ALLOY WHEEL/SIZE	8.0J x 19"	8.0J x 19"
TIRE SIZE	245/40 R19	245/40 R19
CODE	C53W	C53Z
Premium	—	—
Prestige	—	○
R-Sport	●	—
S	—	—

● Standard ○ Option — Not Applicable

Standard and optional features may differ depending on market availability.



20" MATRIX
9 TWIN SPOKE



20" MATRIX
9 TWIN SPOKE



20" STAR
5 TWIN SPOKE

ALLOY WHEEL FINISH	Sparkle Silver	Contrast/Diamond Turned	Sparkle Silver
ALLOY WHEEL/SIZE	8.5J x 20"	8.5J x 20"	8.5J x 20"
TIRE SIZE	255/35 R20	255/35 R20	255/35 R20
CODE	C53H	C53J	C53K
Premium	—	—	—
Prestige	○	—	—
R-Sport	—	○	○
S	—	—	—



20" VENOM
5 TWIN SPOKE



20" VENOM
5 TWIN SPOKE



20" LABYRINTH
5 TWIN SPOKE

ALLOY WHEEL FINISH	Gloss Dark Grey/Diamond Turned	Gloss Black	Gloss Dark Grey/Diamond Turned
ALLOY WHEEL/SIZE	8.5J x 20"	8.5J x 20"	8.5J x 20"
TIRE SIZE	255/35 R20	255/35 R20	255/35 R20
CODE	C53F	C53L	C53G
Premium	—	—	—
Prestige	—	—	—
R-Sport	—	—	—
S	●	○	○

5 CHOOSE YOUR INTERIOR

 Configure your vehicle at JAGUARUSA.COM

PREMIUM						
	SEAT WITH TONAL STITCH	VENEER	UPPER FASCIA WITH TONAL STITCH	HEADLINING MORZINE	CARPET	INTERIOR TRIM CODES
Premium Luxtec seats	Jet with Jet	Gloss Black	Jet with Jet	Light Oyster	Jet	TR23
	Latte with Latte	Gloss Black	Espresso with Espresso	Light Oyster	Espresso	TR24
	Light Oyster with Light Oyster	Gloss Black	Oyster with Oyster	Light Oyster	Oyster	TR25
PRESTIGE						
	SEAT WITH TONAL STITCH	VENEER*	UPPER FASCIA WITH TONAL STITCH	HEADLINING MORZINE	CARPET	INTERIOR TRIM CODES
Taurus Leather seats	Jet with Jet	Gloss Black	Jet with Jet	Light Oyster	Jet	TR26
	Latte with Latte	Gloss Black	Espresso with Espresso	Light Oyster	Espresso	TR27
	Light Oyster with Light Oyster	Gloss Black	Oyster with Oyster	Light Oyster	Oyster	TR28

*Optional veneers are available.

R-SPORT						
	SEAT WITH INSERT AND CONTRAST STITCH	VENEER*	UPPER FASCIA WITH CONTRAST STITCH	HEADLINING MORZINE	CARPET	INTERIOR TRIM CODES
Taurus Leather Sports seats	Jet/Jet with Light Oyster	Gloss Black	Jet with Light Oyster	Jet	Jet	TR29
	Jet/Red with Red	Gloss Black	Jet with Red	Jet	Jet	TR30
	Jet/Light Oyster with Light Oyster	Gloss Black	Jet with Light Oyster	Jet	Jet	TR31
	Brogue/Brogue with Light Oyster	Gloss Black	Jet with Light Oyster	Jet	Jet	TR32

S						
	SEAT WITH INSERT AND CONTRAST STITCH	VENEER*	UPPER FASCIA WITH CONTRAST STITCH	HEADLINING MORZINE	CARPET	INTERIOR TRIM CODES
Sports Taurus Leather 'S' embossed seats	Jet/Jet with Light Oyster	Grey Figured Ebony	Jet with Light Oyster	Jet	Jet	TR33
	Red/Jet with Jet	Grey Figured Ebony	Jet with Red	Jet	Jet	TR34
	Light Oyster/Jet with Jet	Grey Figured Ebony	Jet with Light Oyster	Jet	Jet	TR35
	Brogue/Brogue with Light Oyster	Grey Figured Ebony	Jet with Light Oyster	Jet	Jet	TR36

5 CHOOSE YOUR INTERIOR

Configure your vehicle at [JAGUARUSA.COM](https://www.jaguarusa.com)

Interior shown: Jet Luxtec seats with Jet fascia, Morse Code Aluminum finisher, Gloss Black veneer and Light Oyster headlining.



PREMIUM

INTERIOR COLOR COMBINATIONS

1

SEAT WITH TONAL STITCH



Jet with Jet

2

VENEER



Gloss Black

3

HEADLINING MORZINE



Light Oyster

4

UPPER FASCIA WITH TONAL STITCH



Jet with Jet

5

FINISHER



Morse Code Aluminum

6

CARPETS



Jet



Latte with Latte



Gloss Black



Light Oyster



Espresso with Espresso

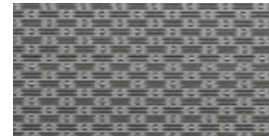

Morse Code Aluminum



Espresso

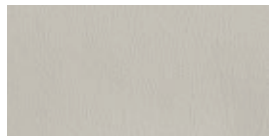

Light Oyster with Light Oyster



Gloss Black

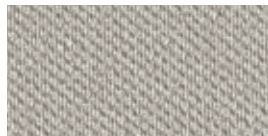

Light Oyster



Oyster with Oyster



Morse Code Aluminum



Oyster

5 CHOOSE YOUR INTERIOR















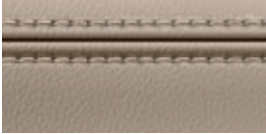

Configure your vehicle at [JAGUARUSA.COM](https://www.jaguarusa.com)

Interior shown: Jet Taurus leather seats with Jet tonal stitch, Jet fascia, Morse Code Aluminum finisher, Gloss Black veneer and Light Oyster headlining.



PRESTIGE

INTERIOR COLOR COMBINATIONS

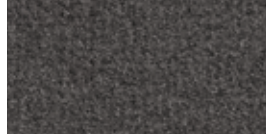
1	2	3	4	5	6
SEAT WITH TONAL STITCH	VENEER	HEADLINING MORZINE	UPPER FASCIA WITH TONAL STITCH	FINISHER	CARPETS
					
Jet with Jet	Gloss Black	Light Oyster	Jet with Jet	Morse Code Aluminum	Jet
					
Latte with Latte	Gloss Black	Light Oyster	Espresso with Espresso	Morse Code Aluminum	Espresso
					
Light Oyster with Light Oyster	Gloss Black	Light Oyster	Oyster with Oyster	Morse Code Aluminum	Oyster

VENEER OPTIONS

Gloss Burl Walnut Veneer

5 CHOOSE YOUR INTERIOR

⚙️ Configure your vehicle at [JAGUARUSA.COM](https://www.jaguarusa.com)

Interior shown: Jet and Light Oyster perforated Taurus leather Sports seats with Light Oyster contrast stitch, Jet fascia with Light Oyster contrast stitch, Dark Morse Code Aluminum finisher, Gloss Black veneer and Jet headlining.



R-SPORT

INTERIOR COLOR COMBINATIONS

1	2	3	4	5	6
SEAT WITH INSERT AND CONTRAST STITCH	veneer	HEADLINING MORZINE*	UPPER FASCIA WITH CONTRAST STITCH	FINISHER	CARPETS
Jet/Jet with Light Oyster	Gloss Black	Jet	Jet with Light Oyster	Dark Morse Code Aluminum	Jet
Jet/Red with Red	Gloss Black	Jet	Jet with Red	Dark Morse Code Aluminum	Jet
Jet/Light Oyster with Light Oyster	Gloss Black	Jet	Jet with Light Oyster	Dark Morse Code Aluminum	Jet
Brogue/Brogue with Light Oyster	Gloss Black	Jet	Jet with Light Oyster	Dark Morse Code Aluminum	Jet

VENEER OPTIONS

Carbon Fiber Veneer, Satin Ash Burl Veneer or Gloss Burr Walnut Veneer

*Morzine headlining replaced by Suedecloth headlining when Luxury Interior Upgrade Package selected.

5 CHOOSE YOUR INTERIOR

Configure your vehicle at JAGUARUSA.COM

Interior shown: Light Oyster and Jet perforated Taurus leather Sports seats with Jet contrast stitch, Jet fascia with Light Oyster contrast stitch, Dark Hex Aluminum finisher, Grey Figured Ebony veneer and Jet headlining.



S

INTERIOR COLOR COMBINATIONS

1

SEAT WITH INSERT
AND CONTRAST STITCH



Jet/Jet with Light Oyster

2

VENEER



Grey Figured Ebony

3

HEADLINING MORZINE*



Jet

4

UPPER FASCIA
WITH CONTRAST STITCH



Jet with Light Oyster

5

FINISHER



Dark Hex Aluminum

6

CARPETS



Jet

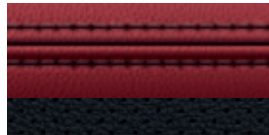

Red/Jet with Jet



Grey Figured Ebony



Jet

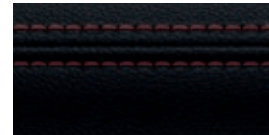

Jet with Red

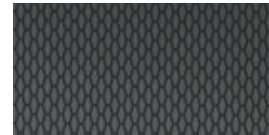

Dark Hex Aluminum



Jet



Light Oyster/Jet with Jet



Grey Figured Ebony



Jet



Jet with Light Oyster



Dark Hex Aluminum



Jet

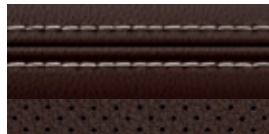

Brogue/Brogue
with Light Oyster



Grey Figured Ebony

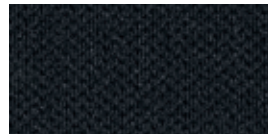

Jet



Jet with Light Oyster

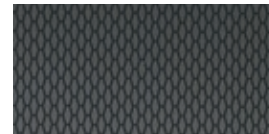

Dark Hex Aluminum



Jet

VENEER OPTIONS

Gloss Black Veneer, Carbon Fiber Veneer, Grey Figured Ebony Veneer or Satin Fine Line Veneer

*Morzine headlining replaced by Suedecloth headlining when Luxury Interior Upgrade Package selected.

5 CHOOSE YOUR INTERIOR

 Configure your vehicle at [JAGUARUSA.COM](https://www.jaguarusa.com)

Gloss Black Veneer

Carbon Fiber Veneer

Satin Ash Burl Veneer

Gloss Figured Ebony Veneer

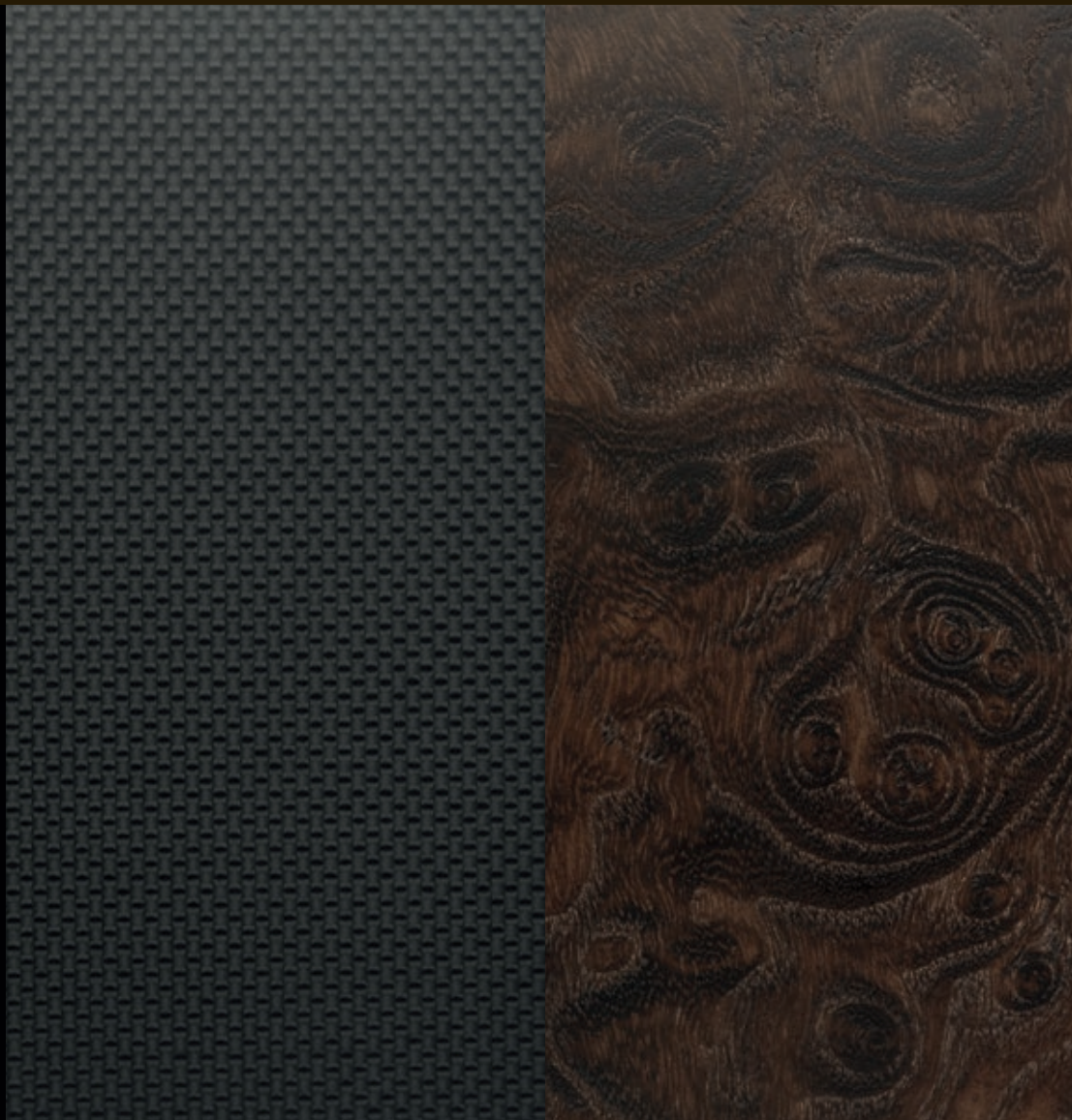

Grey Figured Ebony Veneer



Satin Fine Line Veneer



Gloss Burl Walnut Veneer

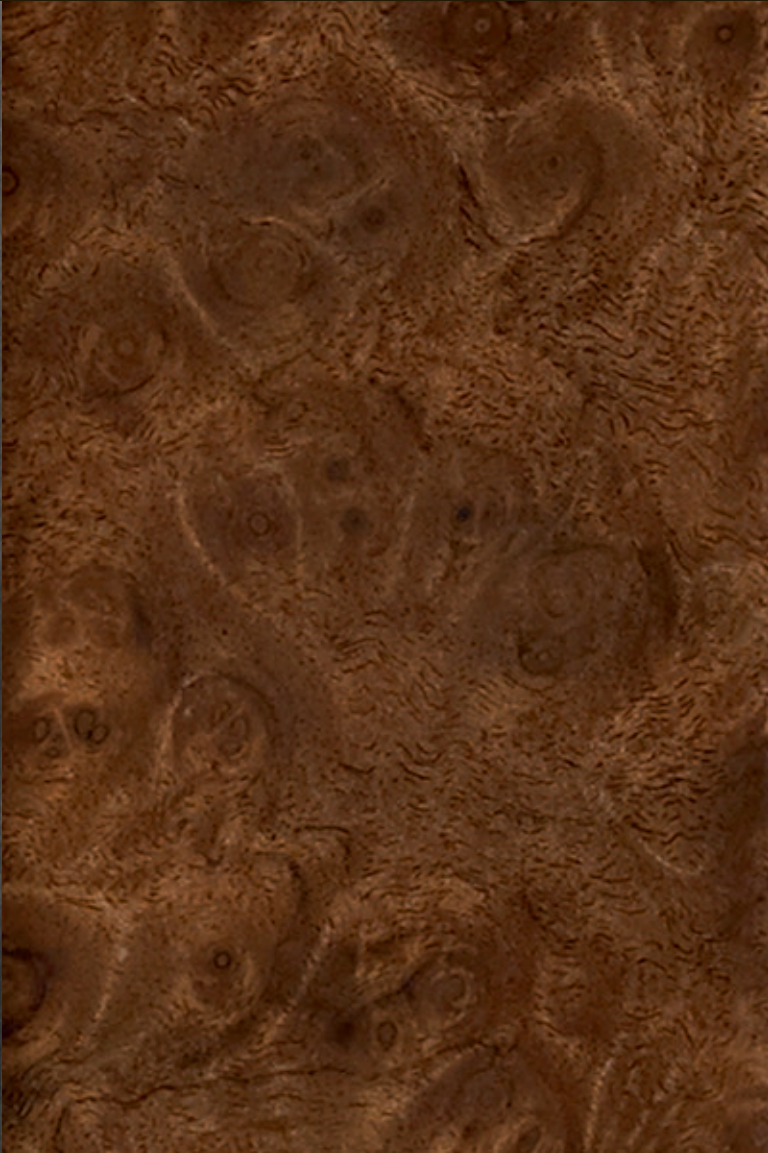

6 CHOOSE YOUR JAGUAR ACCESSORIES

To find out more about the full range of retailer fit Jaguar Accessories, please refer to your Retailer or go to JAGUARUSA.COM

Gloss Black Side Power Vents



Premium Aluminum Paddle Shifters



Premium Carpet Mats

Rubber Mats



Gloss Black Mirror Caps



JaguarDrive Selector –
Black Leather Top



iPad® Holder



Roof Cross Bars



Roof Sports Box



Illuminated Sill Tread Plates



TECHNICAL SPECIFICATIONS

 Configure your vehicle at JAGUARUSA.COM

ENGINES		35t 3.0 LITER V6 340 SUPERCHARGED GAS	S 3.0 LITER V6 380 SUPERCHARGED GAS
Drive		RWD	RWD
Capacity	cc	2,995	2,995
Maximum power	hp	340	380
@rev/min	rpm	6,500	6,500
Maximum torque	lb.ft.	332	332
@rev/min	rpm	4,500	4,500
Transmission		8-speed automatic	8-speed automatic
PERFORMANCE*			
0-60 mph	seconds	5.2	5.1
Top speed	mph	121	121
FUEL CONSUMPTION **			
City	mpg	20	20
Highway	mpg	30	30
Combined	mpg	24	24
Tank capacity	US gallons	19.55	19.55
DIMENSIONS			
Overall length	in	195.0	195.0
Overall width (inc. mirrors)	in	82.3	82.3
Overall width (exc. mirrors)	in	74.0	74.0
Overall height	in	57.4	57.4
Wheelbase	in	116.5	116.5
Front track	in	63.2	63.2
Rear track	in	62.8	62.8
Ground clearance	in	4.57	4.57
Turning circle diameter (curb to curb)	ft	38.1	38.1
Trunk volume	cu-ft	19.1	19.1
WEIGHT†		RWD	RWD
Curb weight from	lb	3,770	3,770
Gross vehicle weight	lb	5,137	5,137
ENGINE AVAILABILITY			
Premium		●	—
Prestige		●	—
R-Sport		●	—
S		—	●

● Available — Not Available

*Always follow local speed limits.

**All figures are EPA estimates. Actual mileage may vary.

†Weights reflect vehicles to standard specifications. Optional extras increase weight.

ENGINES		35t 3.0 LITER V6 340 SUPERCHARGED GAS	S 3.0 LITER V6 380 SUPERCHARGED GAS
Drive		AWD	AWD
Capacity	cc	2,995	2,995
Maximum power	hp	340	380
@rev/min	rpm	6,500	6,500
Maximum torque	lb.ft.	332	332
@rev/min	rpm	4,500	4,500
Transmission		8-speed automatic	8-speed automatic
PERFORMANCE*			
0-60 mph	seconds	5.1	5.0
Top speed	mph	121	121
FUEL CONSUMPTION**			
City	mpg	20	20
Highway	mpg	28	28
Combined	mpg	23	23
Tank capacity	US gallons	19.55	19.55
DIMENSIONS			
Overall length	in	195.0	195.0
Overall width (inc. mirrors)	in	82.3	82.3
Overall width (exc. mirrors)	in	74.0	74.0
Overall height	in	57.4	57.4
Wheelbase	in	116.5	116.5
Front track	in	63.2	63.2
Rear track	in	62.8	62.8
Ground clearance	in	4.57	4.57
Turning circle diameter (curb to curb)	ft	38.1	38.1
Trunk volume	cu-ft	19.1	19.1
WEIGHT†		AWD	AWD
Curb weight from	lb	3,880	3,880
Gross vehicle weight	lb	5,225	5,225
ENGINE AVAILABILITY			
Premium		●	—
Prestige		●	—
R-Sport		●	—
S		—	●

DIMENSIONS

Overall Width (inc mirrors) 82.3 inches

Overall Width (exc mirrors) 74.0 inches

Trunk Volume 19.1 cu.ft.

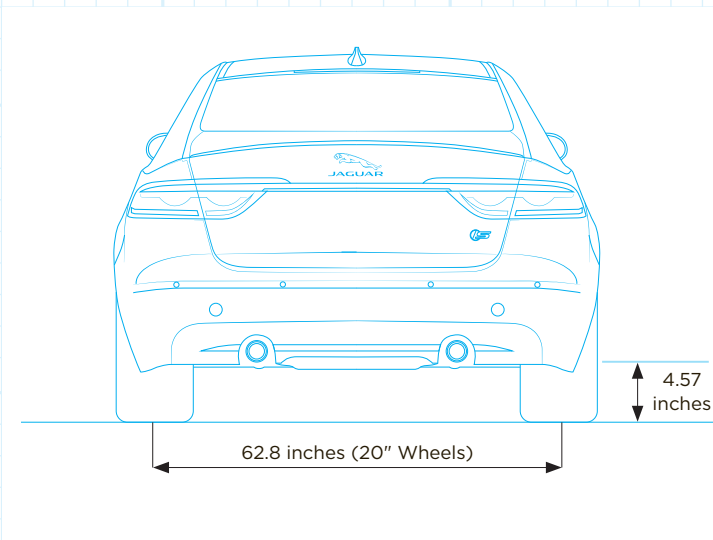
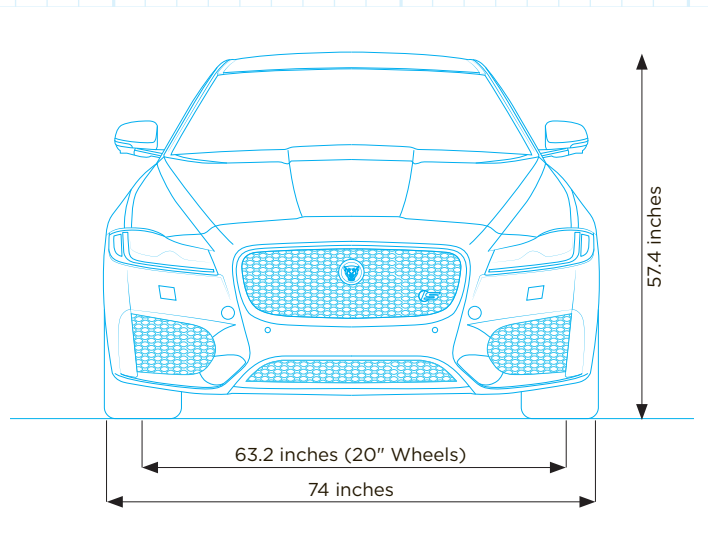

Turning Circle

Curb to curb: 38.1 ft
Wall to Wall 39.2 ft

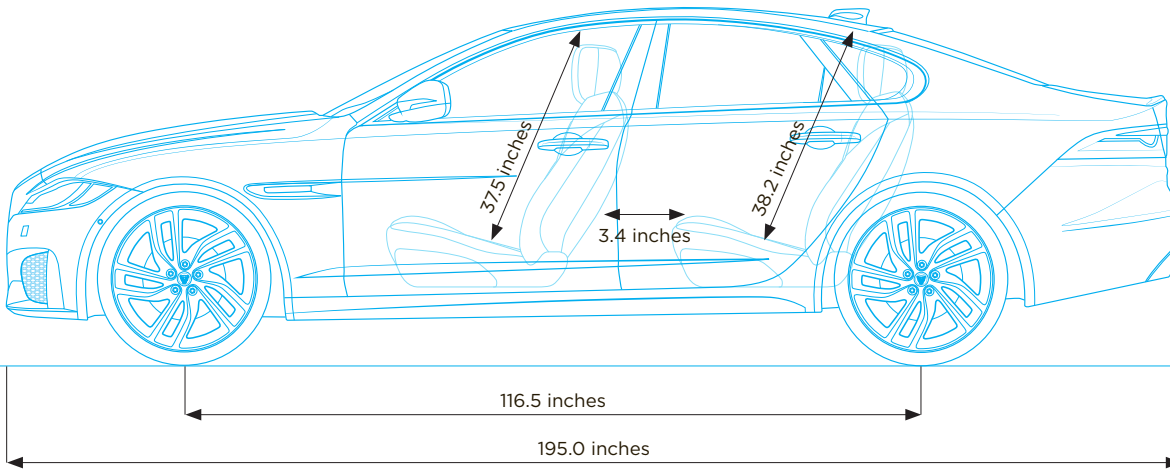
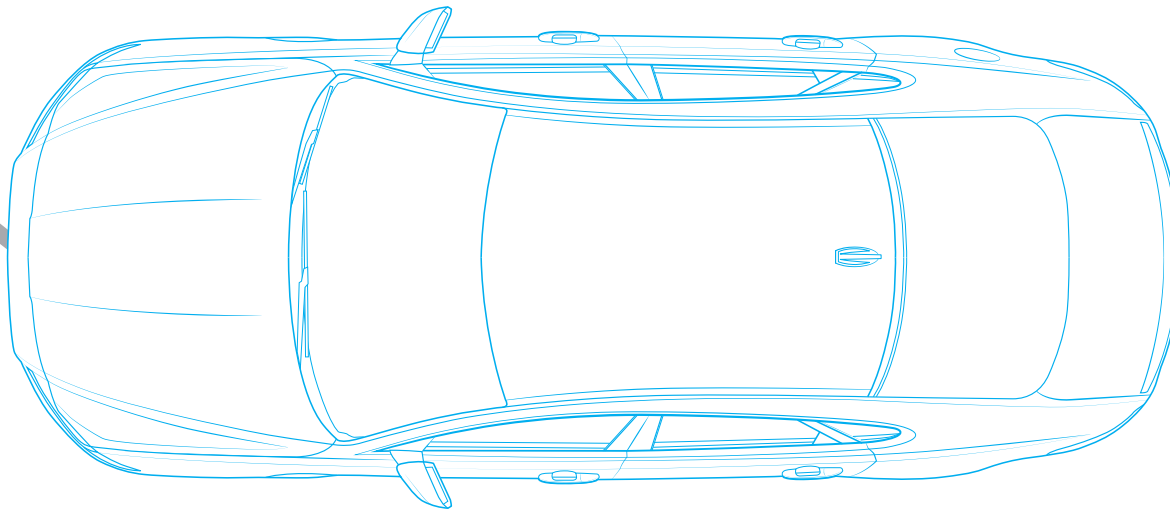

Dimensions were measured with vehicle at unladen weight.
(measured by VDA standard test method using 200 x 100 x 50mm blocks.)

JAGUAR EXPERIENCE

There's no better way to get to know Jaguar than by taking a drive. The Jaguar Experience offers a range of unique opportunities to really find out what it feels like to get the most out of a Jaguar. Our track experiences allow you to push yourself and cars from the incredible Jaguar range to the limit. Jaguar Experience also offers the opportunity to see a Jaguar brought to life during a tour of one of our UK manufacturing facilities.

Find out more by visiting JAGUARUSA.COM



BEHIND THE SCENES

Our factory tours give you the unique opportunity to experience the whole process of how our cars are brought to life - from the moulding of sheet metal to those intricate final touches. At our state-of-the-art production facilities, you'll get to see how skilled technicians and sophisticated machines work seamlessly together to perfect some of Jaguar's most breathtaking cars - from the powerful F-TYPE to the groundbreaking F-PACE performance SUV.

Find out more at JAGUARUSA.COM



DRIVING EXPERIENCES

The opportunity to drive the latest Jaguar cars at their limits, or relive iconic Jaguar history, is rare. Jaguar Driving Experiences offer unique driving adventures you will never forget. Imagine yourself behind the wheel of our highest performing Jaguar models, on a private track, with a Jaguar Experience Instructor at your side. This is the Jaguar Performance Driving Academy.

Find out more at JAGUARUSA.COM



ICONIC EXPERIENCES

Take your driving to the next level with our international adventures facing extreme on-road, and off-road, conditions. Our Iconic Experiences offer journeys and challenges that will test and develop your performance driving skills. Every year, Jaguar customers and enthusiasts join us for our luxury Ice Driving Experience. The exclusive ski resort in Gstaad, Switzerland, is the perfect location to enjoy the thrill of performance driving on ice. Our Ice Driving Experience is a two-day getaway held each winter. You can get a flavour of the event below. Then, if you'd like to be part of it in the next experience, we can keep you posted.

Find out more by visiting JAGUARUSA.COM

THE WORLD OF JAGUAR

Choose an XF and you're joining the exciting World of Jaguar. It makes owning and driving carefree and easy, as well as providing a range of exclusive services and lifestyle products.

JAGUAR ELITECARE

5 YEARS 60,000 MILES

- ④ New Vehicle Limited Warranty
- ⑤ Complimentary Scheduled Maintenance
- ⑥ 24-Hour Roadside Assistance
- ⑦ Jaguar InControl® Remote & Protect™

BEST IN CLASS COVERAGE*

JAGUAR ELITECARE

Enjoy your Jaguar with complete peace of mind.

The XF is now backed by the Best-In-Class Jaguar EliteCare*, our exceptional 5 year / 60,000 mile coverage program including New Vehicle Limited Warranty, Complimentary Scheduled Maintenance, Roadside Assistance and InControl Remote & Protect™.



NEW VEHICLE LIMITED WARRANTY

The New Vehicle Limited Warranty (the "Warranty") lets you enjoy your driving with peace of mind and runs for a best in class 5 years or 60,000 miles, whichever occurs first. The Warranty is fully transferable to subsequent owners and remains in effect throughout the Warranty coverage period.

*Class is cars sold by luxury automobile brands and claim is based on total package of warranty, maintenance and other coverage programs. For complete details regarding Jaguar EliteCare coverage, visit JAGUARUSA.COM, call 1.800.4.JAGUAR or visit your local Jaguar Retailer.

**Servicing your vehicle at the specified interval is critical to maintaining its long-term durability. Failure to perform scheduled maintenance within 1000 miles of the recommended interval may void the Warranty under certain circumstances.



COMPLIMENTARY SCHEDULED MAINTENANCE**

Relax in the knowledge that long-term performance is assured with the Complimentary Scheduled Maintenance Coverage. It covers factory recommended scheduled servicing as detailed in the "Passport to Service" for 5 years or 60,000 miles, whichever occurs first**. A Service Interval Indicator will appear every 16,000 miles or every 12 months, to remind you to take advantage of your complimentary maintenance.

GENUINE PARTS

Jaguar Genuine Parts are designed, tested and manufactured to our uncompromising standards for quality, fit and durability. Each part is engineered specifically for the XF to contribute to optimum performance and to help maximize its lifespan.



ROADSIDE ASSISTANCE

Jaguar Roadside Assistance provides assistance in motoring emergencies, from immobilization due to breakdown or accident to minor problems such as punctures. You can rely on our roadside assistance, whatever the situation, anywhere in North America during the vehicles warranty period.



JAGUAR MAGAZINE

Jaguar Magazine is the official magazine of Jaguar Cars. It features the Jaguar F-PACE, XE, XJ, XF and F-TYPE, and the worlds of luxury, style, design and travel.

JAGUAR COLLECTION

The latest range from the Jaguar Collection has been crafted with the same design execution and attention to detail that goes into all of our cars. This is evident in our clothing range, premium leather items and luxury travel goods. To celebrate Jaguar's heritage we also have a collection that honours past achievements and features race-inspired gift items and apparel. To find out more, please visit your local Jaguar Retailer.

GLOSSARY

A

ADAPTIVE FULL LED HEADLAMPS

Adaptive Headlamps automatically adjust to follow steering inputs, casting light where needed. They will angle the beam when indicating, as well as working in conjunction with Automatic High Beam Assist to prevent your lights from dazzling oncoming traffic.

ADAPTIVE SPEED LIMITER

The Adaptive Speed Limiter, when selected, will assist in limiting vehicle speed to the speed limits as recognized by the Traffic Sign Recognition system.

AUX CONNECTION

Auxiliary (AUX) connections allow for the convenient input of audio signals from personal devices into the vehicle multimedia system.

C

Cd.

The Cd. value is the coefficient drag of the car. It gives an indication of the vehicle's aerodynamic qualities. The lower the value, the more aerodynamically efficient the vehicle design.

CONFIGURABLE INTERIOR MOOD LIGHTING

Configurable Interior Mood Lighting highlights a number of your Jaguar's key functional and styling features and allows adjustment of the ambient light. Choose from a range of 10 colors.

D

DAMPERS/DAMPING

Dampers absorb forces acting on the suspension for greater ride comfort and control. Dampers are also known as shock absorbers.

DEAD RECKONING

Dead Reckoning uses sensors to measure vehicle direction, wheel rotation and inclination. These measurements are calibrated up to 40 times per second to ensure accurate placement of the vehicle even when no GPS signal is available.

DRAG COEFFICIENT

The drag coefficient measures how aerodynamic a car is. See definition of Cd.

E

ECO MODE

Eco Mode encourages fuel efficient driving by reducing throttle sensitivity, selecting more economical engine mapping. It also reduces fuel consumption by reducing the energy demands placed on the engine by climate control and audio systems.

F

FORWARD ALERT

Should a potential collision be detected Forward Alert gives an audible warning and a visual warning in the instrument cluster.

FOUR-ZONE CLIMATE CONTROL

Automatic four-zone climate control that allows rear occupants to optimize cabin temperature and air flow for their individual position.

G

GPS

The Global Positioning System (GPS) uses satellites to determine the car position. By cross-referencing this with road maps stored in the vehicle memory, the navigation system provides route guidance and tracks the car location.

I

INTERIOR MOOD LIGHTING

Interior mood lighting highlights many of the cabin's key features and design details in a relaxing soft Phosphor Blue glow.

INTELLIGENT STOP/START

Stop/Start is a technology that stops the engine when it is not needed, improving the fuel economy and reducing the car CO₂ emissions. The engine will restart as soon as the driver's foot comes off the brake pedal. The engine will be operating at full capacity before the driver's foot has touched the accelerator pedal.

J

JAGUAR SIGNATURE 'J' BLADE DAYTIME RUNNING LIGHTS

J-Blade Daytime Running Lights are separate LED running lights, in a distinctive 'J' shape, built into the headlamps. They emphasize the striking on-road style of Jaguar vehicles.

JAGUARDRIVE SELECTOR

The JaguarDrive Selector rises from the center console on start up. It is a rotary shifter that allows you to quickly shift between drive modes.

L

LED HEADLAMPS

Multiple powerful LED emitters give a clearer light in low light conditions. Further complemented with LED J-Blade Daytime Running Lamps incorporating LED Direction Indicators. These lights also integrate Jaguar's Adaptive Lighting and Auto High Beam Assist systems.

M

MHL CONNECTION

A Mobile High-Definition Link (MHL) enables connection between a personal device and the InControl infotainment system. It is designed for seamless transfer of audio-visual data.

10.2 INCH MULTI-TOUCH DISPLAY

The Multi-touch functionality of InControl Touch Pro™ 10.2 inch Display allows the screen to recognize multiple points of contact. This provides direct control of the system's features in a more natural, intuitive way, enabling gestures such as pinch and zoom.

S

SATELLITE VIEW

Satellite View allows you to view satellite imagery as an optional view mode for the navigation system.

SOLID STATE DRIVE

Solid State Drives are storage devices with no moving parts designed for rapid retrieval of large quantities of data.

V

12.3 INCH VIRTUAL NAVIGATION MAP

The 12.3 inch Virtual Navigation Map is a TFT (Thin Film Transistor) screen that replaces the traditional instrument cluster. It displays a wide range of key driving information. Four graphical themes and a 3D map view are available.

W

WINTER MODE

By selecting Winter Mode, the system automatically dampens acceleration and applies more gradual torque for improved traction in slippery conditions.

DISCLAIMERS

¹ Do not use Jaguar InControl® features under conditions that will affect your safety or the safety of others. Driving while distracted can result in loss of vehicle control.

² Driving while distracted can result in loss of vehicle control. Do not operate, adjust or view the navigation or multimedia systems under conditions that will affect your safety or the safety of others. Only use mobile phones, and other devices, even with voice commands, when it is safe to do so.

³ The Wi-Fi hotspot is intended for passenger use only. Jaguar InControl® features may require an additional subscription with separate terms and conditions.

⁴ A 3-month trial subscription to the SiriusXM® All Access package is included with the vehicle, which gives you access to 175+ channels of premium programming. Plus you can stream SiriusXM® on your computer, smartphone or tablet – it's included in your trial. If you decide to continue service after your trial, the subscription plan you choose will automatically renew thereafter and you will be charged according to your chosen payment method at then-current rates. Fees and taxes apply. To cancel you must call SiriusXM® at 1-866-635-2349. See the SiriusXM® Customer Agreement for complete terms at siriusxm.com. All fees and programming are subject to change. SiriusXM® Satellite Radio is not available in Alaska, Hawaii, or Puerto Rico.

⁵ These features are not a substitute for driving safely with due care and attention and will not function under all circumstances, speeds, weather and road conditions, etc. Driver should not assume that these features will correct errors of judgment in driving. Please consult the owner's manual or your local Jaguar Retailer for more details.

⁶ Please remember that the safety belts in a vehicle constitute the primary protection system for driver and passengers in collisions. Airbags are not designed to deploy in all collisions. The airbag Supplemental Restraint System (SRS) is a supplement to the safety belts and is designed to work as a system with the safety belts. Although airbags provide additional protection, airbags without safety belts do not provide optimal protection in a crash. Always wear your safety belts. Children younger than 13 years old should always be properly restrained in a back seat, away from airbags. Never place an infant seat in the front seat.

⁷ All figures are EPA estimates. Actual mileage may vary.

⁸ Always follow local speed limits.

Meridian is the registered trademark of Meridian Audio Limited.

The Bluetooth® word mark and logos are owned by the Bluetooth SIG, Inc. and any use of such marks by Jaguar Land Rover Limited is under license.

iPod, iPod touch and iPad are trademarks of Apple Inc, registered in the US and other countries.

©2015 Jaguar Land Rover North America, LLC

VEHICLE SHOWN FRONT AND BACK COVERS: XF S IN GLACIER WHITE WITH OPTIONAL 20" LABYRINTH ALLOY WHEELS AND OPTIONAL BLACK PACK

SOME OF THE VEHICLES FEATURED IN THE PHOTOGRAPHS THROUGHOUT THIS BROCHURE ARE EUROPEAN MODELS AND MAY NOT BE AVAILABLE IN NORTH AMERICA. PLEASE CONSULT YOUR LOCAL JAGUAR RETAILER FOR SPECIFIC MODEL AVAILABILITY.



IMPORTANT NOTICE

Jaguar Land Rover Limited is constantly seeking ways to improve the specification, design and production of its vehicles and alterations take place continually. While every effort is made to produce up-to-date literature, this brochure should not be regarded as an infallible guide to current specifications, nor does it constitute an offer for the sale of any particular vehicle. Distributors and Retailers are not agents of Jaguar Land Rover Limited by any express or implied undertaking or representation. Comparisons are based on manufacturer's own data and testing.

COLORS

Print and online colors are representative only.

ENVIRONMENTAL INNOVATION AT JAGUAR

Jaguar is proud to continue the company's tradition with its approach to Environmental Innovation. From the choice of lightweight materials and lean production methods to the efficiency of its engines and designs, Jaguar is committed to operating as a more sustainable business and reducing its overall environmental impact.

The company flagship model, the XJ model was the first in the company to achieve ISO14040, the international standard for vehicle 'life cycle assessment'. This certification measures the environmental impact of the XJ from component material sourcing and manufacturing process, through driving 200,000 km. But that's not all. Every new Jaguar is designed to be 85% Recyclable/Reusable and 95% Recoverable at the end of the vehicle life.

The all-new XF, XE, XJ and F-TYPE innovative use of lightweight aluminum, which incorporates up to 50% closed-loop recycled material from the manufacturing process of the body structures, provides considerable performance benefits. This includes improved fuel consumption and less CO₂ emissions during the use phase of the Life Cycle due to lighter structures. Our on-going target is to ensure scrap aluminum reclaimed from our stamping process is to be segregated and recycled through a closed loop system and re-melted into the same grade quality sheet, therefore reducing CO₂ emissions during the production phase of the Life Cycle. Jaguar is committed to reducing dependency on fossil fuels, using fewer resources and creating less waste as part of our approach to sustainability excellence.

The company plan includes 25% reduction targets in operating and tailpipe CO₂ emissions, waste to landfill, logistics efficiencies (15%) and water consumption (10%), all based on per vehicle built since 2007. In addition the manufacturing assembly CO₂ emissions of each Jaguar built in the UK since 2009 is 100% offset. For each tonne of CO₂ emitted in the assembly process, Jaguar invests in projects that reduce an equivalent tonne of CO₂ elsewhere. Taking into account the company's global sales growth and increased investment in more efficient operating facilities, we are proud to have delivered and in some cases exceeded our Environmental Innovation targets as planned for 2012. And we are on track to meet our 25% reduction in joint European fleet average tailpipe CO₂ emissions by 2015.

Looking forward, we have developed our 2020 vision for sustainable business growth that focuses on continued improvements in tailpipe CO₂ emissions, operational carbon neutrality and zero waste. To date the company has offset over 6 million tons of CO₂, provided over 4,000 direct jobs in 60 emissions reduction projects in 17 countries and improved the lives of over 1 million people in our global cook stoves emissions reduction programme.

But it doesn't stop there. Our manufacturing facilities have been certified to ISO14001 since 1998 and we are credited to Platinum Plus level in the UK's Business in the Community Corporate Responsibility Index.

Castrol EDGE™ Professional is recommended by Jaguar.

Jaguar Land Rover North America LLC
555 MacArthur Boulevard
Mahwah, NJ 07430-2327
JAGUARUSA.COM

November 2015/16MY
JLM/09/02/30/1115

