

JAGUAR XF SEDAN AND NEW XF SPORTBRAKE 2018



THE ART OF PERFORMANCE





BY APPOINTMENT TO
HM THE QUEEN
MANUFACTURERS OF
MOTOR VEHICLES
JAGUAR LAND ROVER LIMITED
COVENTRY



BY APPOINTMENT TO
HRH THE DUKE OF EDINBURGH
MANUFACTURERS OF
MOTOR VEHICLES
JAGUAR LAND ROVER LIMITED
COVENTRY



BY APPOINTMENT TO
HRH THE PRINCE OF WALES
MANUFACTURERS OF
MOTOR VEHICLES
JAGUAR LAND ROVER LIMITED
COVENTRY



THE ART OF PERFORMANCE

Every day we push performance to its limit. Our performance. Our cars' performance.
We innovate, we engineer, we design. We master rules and then break them.
Only to push further. Past the limits of convention. This is when performance becomes art.

Jaguar. The Art of Performance.





CONTENTS

INTRODUCTION

The Concept of the XF	06
The XF - The Facts	08

DESIGN

Exterior Principles	10
Exterior Aerodynamics	12
Interior	14
Interior Space	16

PERFORMANCE

Engines Overview	22
Advanced Aerodynamics	26
Lightweight Aluminum Architecture	29
Chassis and Suspension	30

DRIVING TECHNOLOGY

Advanced Driving Dynamics	32
Added Driver Assurance	34
Advanced Drivetrain Technology	37
Torque Vectoring	39
Stability and Control	41
Head-up Display	43

JAGUAR INCONTROL® TECHNOLOGIES

Infotainment and Connectivity	44
Touch and Connect	46
Touch Pro and Connect Pro	48
Audio	50

DRIVER ASSISTANCE

Advanced Driver Assistance	52
----------------------------	----

PERSONALIZATION

The XF - Your Choice	54
Choose your Engine	56
Choose your Model & Packages	58
Choose your Color	66
Choose your Wheels	68
Choose your Interior	70
Choose your Jaguar Gear Accessories	84
Technical Specifications	92
Dimensions	94

JAGUAR WORLD

Jaguar Experience	98
The World of Jaguar	100
Glossary	102
Legal Information	103



Scan to find out more about the Jaguar XF.

VEHICLES SHOWN: XF SPORTBRAKE S IN YULONG WHITE AND XF SEDAN R-SPORT IN CORRIS GREY WITH OPTIONAL EQUIPMENT

VEHICLES SHOWN ARE FROM THE JAGUAR GLOBAL RANGE. SPECIFICATIONS, OPTIONS AND AVAILABILITY WILL VARY BETWEEN MARKETS AND SHOULD BE VERIFIED WITH YOUR LOCAL JAGUAR RETAILER





INTRODUCTION

THE CONCEPT OF XF

The 2018 Jaguar XF builds on the success of the 2017 Jaguar XF. Possessing an unrivalled combination of style and substance, it delivers an utterly seductive blend of design, dynamics and refinement to create a car that offers true excitement. All enhanced by state-of-the-art technologies that keep you connected and entertained.

The XF sits in the Jaguar range between the taut athleticism of the Jaguar XE and the supreme luxury of Jaguar XJ. The fusion of these outstanding Jaguar attributes is what creates the XF – one of the most dynamic, premium sports sedans. The New XF Sportbrake complements the distinctive 'coupe' lines and dynamism of the XF Sedan with even greater space and versatility.

VEHICLES SHOWN: XF SPORTBRAKE S IN YULONG WHITE AND XF SEDAN R-SPORT IN CORRIS GREY WITH OPTIONAL EQUIPMENT



XF - THE FACTS

An outstanding combination of advanced engineering, the latest technology and contemporary design sets the XF apart.

PERFORMANCE

Find your perfect balance of economy and power in the XF Sedan and Sportbrake engine range. Many engines feature our Ingenium technology, including the 2.0 liter 4 cylinder 180HP Turbocharged Diesel. The most powerful XF engine, the 3.0 liter V6 380HP Supercharged, can sprint from 0-60 mph in 5.0 seconds[†] and reach a top speed of 121mph*⁷ in 5.0 seconds[†].

SPORTBRAKE REAR AIR SUSPENSION

Even when fully loaded, the comfort and precise handling of the XF Sportbrake is maintained by self-leveling rear air suspension. This system automatically inflates air springs to counteract the weight of heavy loads, helping ensure a level chassis and ride height.

JAGUAR ELITECARE

Enjoy your Jaguar with peace of mind. The XF is backed by Jaguar EliteCare*⁹, our exceptional 5 year / 60,000 mile coverage program including New Vehicle Limited Warranty, Complimentary Scheduled Maintenance, Roadside Assistance and Jaguar InControl[®] Remote & Protect[™].

*Please see page 103 for further information.

**Adaptive Surface Response system is only available on the Jaguar XF S AWD and Jaguar Sportbrake S models.

†40:20:40 split fold rear seats are standard on Premium, Prestige, R-Sport and S models and not available on Standard XF.

††Feature only available as part of Touch Pro.

‡Engine performance representative of XF Sedan only.

For detailed XF Sedan and Sportbrake technical specifications, see pages 92 to 93.

Some features described here are optional.

VEHICLES SHOWN: XF SPORTBRAKE S IN YULONG WHITE AND XF SEDAN R-SPORT IN CORRIS GREY WITH OPTIONAL EQUIPMENT

DYNAMIC DESIGN

With a sleek, low swooping roofline and optional 17.2 sq ft panoramic glass roof, the XF Sportbrake makes no compromise between assertive style and versatility. Perfectly executed to carry more, its proportions have been shaped to achieve aerodynamic excellence.



ADDED INTELLIGENCE

Innovative technologies make driving easier. The XF offers optional adaptive LED headlights, Traffic Sign Recognition with Adaptive Speed Limiter, Lane Keep Assist with Driver Condition Monitor, Emergency Braking, Adaptive Cruise Control with Queue Assist*⁵, Park Assist, and now Blind Spot Assist*⁵. On the Sportbrake with Powered Gesture trunk, you can access the trunk when your hands are full. Simply present your foot under either rear side of the bumper and the trunk opens.

CRAFTSMANSHIP AND SPACE

Contemporary craftsmanship and a luxurious, practical interior with the space to stretch out and enjoy every trip. Front and rear passengers will appreciate leg, knee and headroom that are ample and generous. You can choose the optional 40:20:40 rear seating[†] configuration for increased volume and versatility.

CONNECTIVITY

Every drive in the XF is enhanced by Jaguar InControl[®] Technologies. InControl is a suite of products and services that connects you with your XF and links the XF to the wider world. It ensures you are always in touch*¹.

LIGHTWEIGHT ALUMINUM ARCHITECTURE

The Lightweight Aluminum Architecture of the XF creates a strong body that delivers precise and responsive sports handling.

ADVANCED DRIVETRAIN TECHNOLOGY

The XF offers All Wheel Drive with Intelligent Driveline Dynamics and Adaptive Surface Response (if fitted to model)**. This enhances the legendary Jaguar handling, agility and ride, and gives added assistance in most conditions*⁵.

ADVANCED AERODYNAMICS

The XF has a low drag coefficient which allows it to cut through the air, reducing wind noise for enhanced refinement. The underside of the car is aerodynamically designed to be as smooth as possible, while apertures in the front bumper optimize airflow through the wheel arches.





DESIGN EXTERIOR PRINCIPLES



DESIGN PURITY

ADAPTIVE LED HEADLIGHTS

VEHICLE SHOWN RIGHT: XF SEDAN R-SPORT IN CORRIS GREY
WITH OPTIONAL EQUIPMENT

"It's about paring it down to the bare essentials. Good designers have always said less is more."
Ian Callum, Jaguar Design Director.

The XF demonstrates the Jaguar principles of design purity. Strong lines radiate dynamic character and enhance the vehicle capabilities - be it improving aerodynamics, visibility or stability. The XF is available with adaptive LED headlights*^{5†} complementing the Jaguar signature 'J' blade Daytime Running Lights and giving the vehicle a striking on-road presence. LED light quality is closer to daylight, helping to distinguish objects.

*Please see page 103 for further information.

†Optional feature, Xenon headlights are also available depending on the model chosen.



776 XCN

EXTERIOR AERODYNAMICS



AERODYNAMIC DESIGN

F-TYPE INSPIRED DESIGN

The sweeping exterior design of the XF is naturally aerodynamic. Its advanced form enhances handling, dynamics and refinement. Airflow is carefully managed through and around the car. Intakes either side of the front grille draw air in, then channel it out from the wheel arches to reduce turbulence. As air flows along the car, pressure differences that can cause drag are minimized by the flush, aerodynamically optimized sides.



At the rear, the XF sedan tail lights feature a distinctive, Jaguar F-TYPE inspired, double roundel and intersecting horizontal detail. The LED brake lights are not only brighter than halogen bulbs, they use less energy. LEDs also illuminate faster - so following drivers can react more quickly to braking. Within the tail lights is a pinstripe graphic - one of the many exquisite finishing touches on the XF.

VEHICLES SHOWN: XF SPORTBRAKE S IN YULONG WHITE AND XF SEDAN R-SPORT IN CORRIS GREY WITH OPTIONAL EQUIPMENT





Darkrest
Over Gaddy
Darkrest
412

70 90 110 130
50 0 150
30 10 170 190

3 4 5
P

HOME 08:30
Darkrest Over Gaddy 72°F Sunny 87°
High St Kensington

SYNC MAX A/C AUTO
MAX A/C A/C

P R N D S



INTERIOR



**DRAMATIC START-UP
SEQUENCE**

**CONTEMPORARY
CRAFTSMANSHIP**

Open the door and the Start button entices you inside. Pulsing with a heartbeat it creates an emotional connection between driver and machine. Its 72 per minute double beat is the same as a jaguar cat at rest. The XF is poised, ready for action. Now push the Start button. The car awakens and, if fitted, its mood lighting illuminates. With perfect choreography, air vents rotate open when the air conditioning is in use, the JaguarDrive Selector™ rises smoothly, and the engine growls – all inspiring you to anticipate the drive ahead.

The XF interior offers outstanding comfort, a sense of wellbeing and a wealth of choices. The number of switches and buttons is kept to a minimum to keep the look clean and tidy, as well as making them easy to use. Whichever XF interior combination you choose, materials used are always of the highest quality. Leather and finishes are selected with the greatest care to ensure that, inside the XF, everything is luxurious to the touch. Whether you prefer aluminum, carbon fiber, or wood veneer finishes to complement the beautiful selection of materials, your XF will always look and feel just right.

The XF Sportbrake offers a new ionization system that improves air quality. With this optional system, air is passed through an ionizer that filters and purifies the airflow before it is circulated within the cabin. This helps to neutralize odors and minimizes bacteria and pollution for a more pleasant and healthy in-car environment.

INTERIOR SHOWN: XF SEDAN S FEATURING LIGHT OYSTER/EBONY SEATS WITH EBONY UPPER FASCIA WITH CONTRAST STITCH, EBONY CARPET AND EBONY HEADLINING PLUS OPTIONAL EQUIPMENT





1. Headroom 38 inches (39.1 inches on XF Sportbrake) 2. Knee room 3 inches

INTERIOR SPACE



GENEROUS REAR SPACE

IMPRESSIVE VERSATILITY

In both XF Sedan and Sportbrake, the rear of the cabin is a destination of luxury, choice and space. With generous rear knee room, rear legroom and rear headroom, there is plenty of room to relax. It all adds up to greater comfort and well being for passengers.

Available interior mood lighting enhances the interior atmosphere. Opt for the Luxury Interior Upgrade Package and Configurable Interior Mood Lighting will offer you a choice of ten interior colors. In addition, the Four-zone Climate Control will give individual passengers the opportunity to set their own temperature and airflow.

At 17.8 cubic feet, the cargo space of the XF Sedan offers plenty of carrying capacity. For even greater versatility, choose the optional 40:20:40 rear seating configuration - it increases cargo space to an impressive 31.25 cubic feet. This outstanding practicality is taken to the next level in the XF Sportbrake with 31.7 and 69.7 cubic feet of rear cargo space respectively.

INTERIOR SHOWN: XF SEDAN S FEATURING LIGHT OYSTER/EBONY SEATS WITH EBONY UPPER FASCIA WITH CONTRAST STITCH, EBONY CARPET AND EBONY HEADLINING WITH OPTIONAL EQUIPMENT AND ACCESSORIES



SPACE AND VERSATILITY



SUBSTANTIAL CARGO SPACE

ACTIVITY KEY

The versatile interior of the XF Sportbrake is designed to meet the demands of your lifestyle. Its cargo space provides 31.7 cubic feet of space with the rear seats in place. Fold the rear seats down, and you'll create a space that is 79 inches in length and features 69.7 cubic feet of luggage capacity plus discreet underfloor storage.

To make things a bit easier, the XF Sportbrake offers a Powered Gesture Tailgate as standard and Activity Key as an option. The Activity Key is a robust and fully waterproof wristband that allows you to enjoy a range of activities - from skydiving to swimming - while giving you immediate access to the car at all times. The conventional key fob can remain within the car as it is deactivated for security purposes.

INTERIOR SHOWN: XF SPORTBRAKE S FEATURING BROGUE SEATS WITH CONTRAST STITCH, EBONY CARPET AND EBONY HEADLINING WITH OPTIONAL EQUIPMENT







40:20:40 SPLIT FOLD SEATS

FIXED PANORAMIC ROOF

The rear seats of the XF Sportbrake fold completely flat or can be divided with a 40:20:40 split, using a thoughtfully placed remote release that's accessible from the tailgate area. Easy-to-use optional cargo space rails help further increase the adaptability of cargo space storage, and an available divider net prevents objects from falling onto the rear seats.

Introducing even more natural light and airiness to the interior, is the large, standard fixed panoramic roof in the XF Sportbrake.

PERFORMANCE ENGINES OVERVIEW



INGENIUM ENGINES

STOP/START TECHNOLOGY

Ingenium technology underpins the 2.0 liter 4-cylinder diesel and gas engines in the XF range. These low friction, all-aluminum engines have stiff cylinder blocks and twin balancer shafts to ensure inherently low levels of vibration, for smooth day-to-day performance. All engines are equipped with Stop/Start technology and smart regenerative charging - harvesting kinetic energy from braking to charge the battery.



INGENIUM DIESEL ENGINE

318 lb-ft of Torque

The **Ingenium 2.0 liter 4-cylinder 180HP Turbocharged Diesel** offers impressive performance for an engine of this size. It offers high levels of torque - a balance achieved thanks to its variable geometry turbocharger. Adapting to the changing flow of exhaust gases, it maximizes low speed torque for broad power and responsiveness that is uniform, progressive and avoids lag.

The XF offers a choice of gas engines, including two from our Ingenium range. With their lightweight, all-aluminum design, and widespread use of low-friction roller bearings, Ingenium gas engines are built for smooth, efficient performance. To guarantee a responsive drive and effortless acceleration, every XF gas engine makes use of a rapid-shifting, 8-speed Automatic Transmission. All engines are equipped with Stop/Start technology and smart regenerative charging – harvesting kinetic energy from braking to charge the battery.



INGENIUM GAS ENGINES** UP TO

0-60 mph from 5.5 seconds*⁷

The **Ingenium 2.0 liter 4-cylinder 247HP Turbocharged Gas** engine delivers outstanding usable power and torque. For excellent acceleration and effortless overtaking, maximum torque is available between 1,200-4,500 rpm. This engine twin scroll turbocharger is fed by an integrated exhaust manifold that synchronizes exhaust pulses from two separate pairs of cylinders – reducing turbo lag and improving engine response.

The **Ingenium 2.0 liter 4 cylinder 296HP Turbocharged Gas[†]** engine has impressive power and balance. For almost instant boost and high efficiency, its low inertia twin-scroll turbocharger features low-friction ball bearings and a high flow compressor wheel. Underpinned by the turbocharger's increased aerodynamic efficiency, the engine delivers rapid acceleration and maximum torque of 295lb-ft between 1,500-4,500rpm.

*Please see page 103 for further information. **Engine performance and efficiency figures representative of XF Sedan only. For detailed XF Sedan and Sportbrake technical specifications, see pages 92 to 93.

[†]Only available on XF Sedan. Introduced Fall 2017.



GAS ENGINE UP TO**

0-60 mph in 5.0 seconds*⁷

The **3.0 liter V6 Supercharged Gas engine** features a Roots-type twin vortex supercharger that provides linear delivery of power and maximizes responsiveness. This results in performance much like larger engines. The engine also features dual independent variable cam timing to vary inlet and exhaust valve operation, working alongside lightweight pistons with ultra-low friction piston rings, for increased performance. For added refinement there is a twin, contra-rotating balancer shaft system.

ADVANCED AERODYNAMICS



LOW DRAG

CD 0.28**

The XF form has been designed for aerodynamic efficiency and stability at highway speeds. With a drag coefficient as low as Cd 0.28**, the Jaguar XF cuts through the air - helping to reduce fuel consumption and lower emissions. Every element exploits the maximum aerodynamic potential while preserving the stunning proportions of the XF. Apertures in the front bumper outer edges channel air through vents in the wheel arches and out over the front wheels. The airflow then passes along the XF sides where the doors have a flatter cross sectional profile to minimize air pressure differences and contribute further to reduced drag. Even the extensive under body protection is designed to make the XF as refined as possible.

**XF Sedan only. Drag coefficient for XF Sportbrake is Cd 0.29.

VEHICLE SHOWN: XF SEDAN IN SANTORINI BLACK WITH OPTIONAL EQUIPMENT



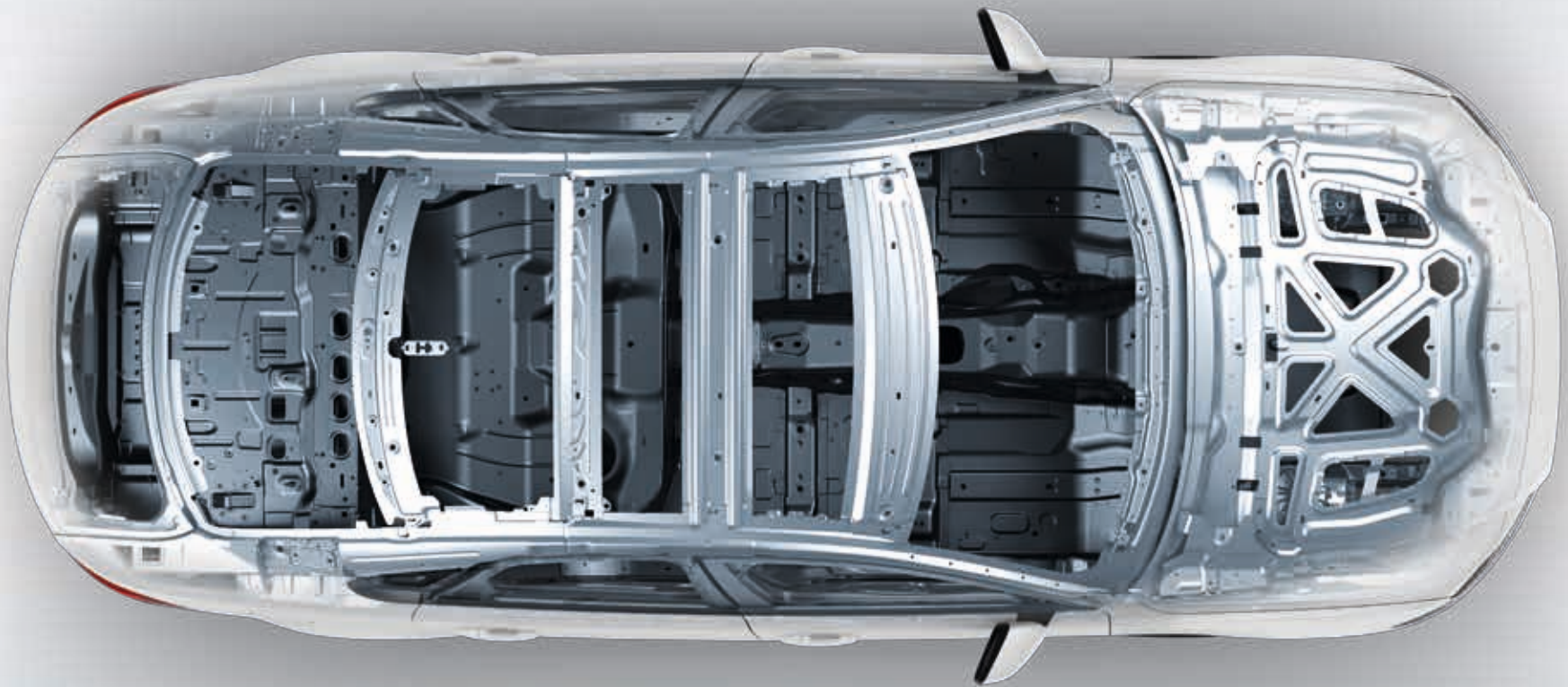

LIGHTWEIGHT ALUMINUM ARCHITECTURE

 **STRONG** | **RIGID** | **75% ALUMINUM**

Jaguar has been at the forefront of aluminum car construction for more than a decade. The latest innovation is our high-strength Lightweight Aluminum Architecture, which is strong and reduces weight, it is also stiff – underpinning the precise, agile handling of the XF. Aluminum has also been used to form the body sides, hood and front wings. These panels are bonded together with a strong adhesive, then punched with zinc-coated, boron steel rivets that compress the adhesive to form an airtight bond and a strong, rigid structure. This cutting-edge process, coupled with the Lightweight Aluminum Architecture, contributes towards a weight saving of up to 265 lbs over the previous generation XF.

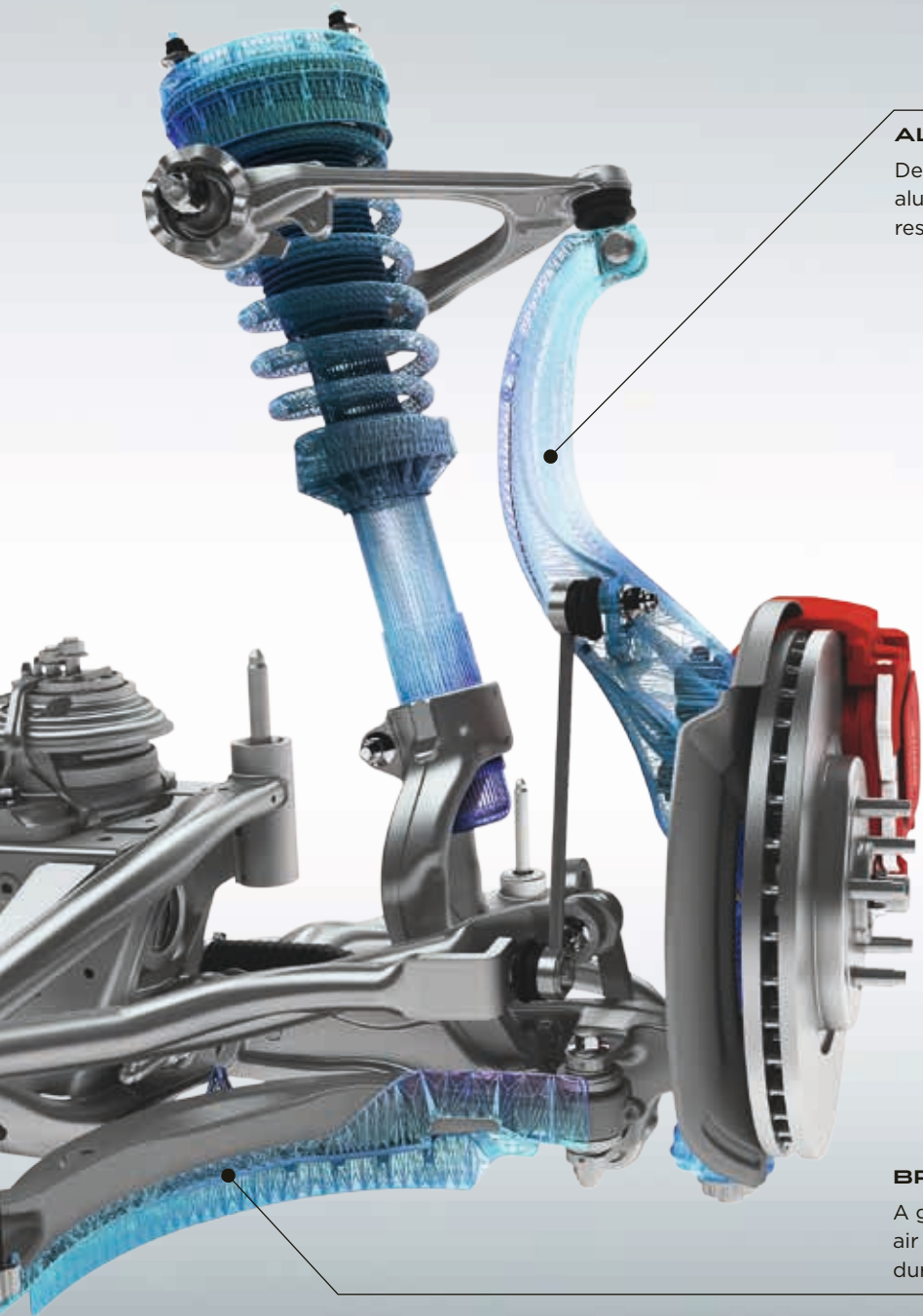

ALUMINUM FRONT KNUCKLE

Designed to optimize stiffness and strength, the lightweight aluminum front knuckle helps improve the XF agility, responsiveness and refinement for sports car-like control.

CHASSIS AND SUSPENSION

> ADVANCED SUSPENSION TECHNOLOGY

COMFORTABLE AND DYNAMIC

The XF responds with agility and performs with dynamism while maintaining ride comfort – it's a unique balance that makes it a Jaguar. The ideal foundation for these driving dynamics is the light, yet strong and stiff, Lightweight Aluminum Architecture with its near 50:50 weight distribution.

The sophisticated front and rear suspension systems complete a chassis that achieves a superb combination of sportiness and refinement. Advanced damper technologies – both passive or adaptive – improve ride quality still further and extend the XF breadth of dynamic capabilities. The suspension control, agility and feedback give the XF the spirit of a sports car.

BRAKE SCOOP

A glass-filled polypropylene brake scoop channels air onto the brakes for enhanced brake performance during enthusiastic driving.

INTEGRAL LINK REAR SUSPENSION

Integral Link suspension allows the XF to realize an ideal combination of refined, luxurious ride and sharp, responsive handling. The system separates and independently manages the lateral, longitudinal and vertical forces acting on the suspension for enhanced control and comfort. Many components are forged or hollow-cast aluminum – the optimum production techniques for strong, lightweight suspension.

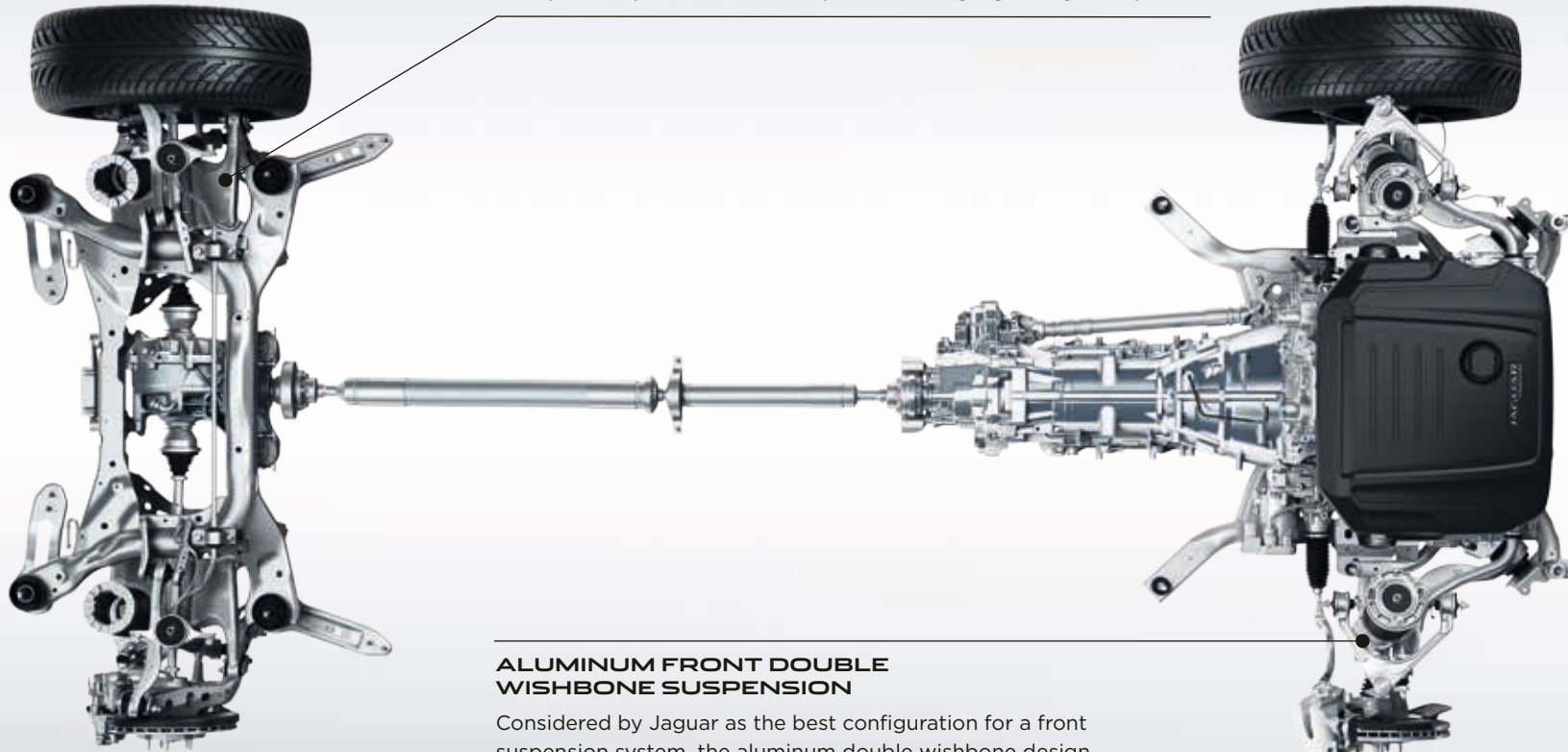

ALUMINUM FRONT DOUBLE WISHBONE SUSPENSION

Considered by Jaguar as the best configuration for a front suspension system, the aluminum double wishbone design is modeled closely on the F-TYPE for precise handling and steering response.

DRIVING TECHNOLOGY ADVANCED DRIVING DYNAMICS

ENHANCING AGILITY

Dynamic Mode revises the software of the vehicle to further enhance the sporting character. It sharpens the throttle response, increases steering weighting and performs gearshifts more quickly and at higher engine speeds. It also brings visual drama to the driver as the instrument cluster takes on a red glow. Dynamic Mode enhances your connection with the XF inherent Jaguar performance.

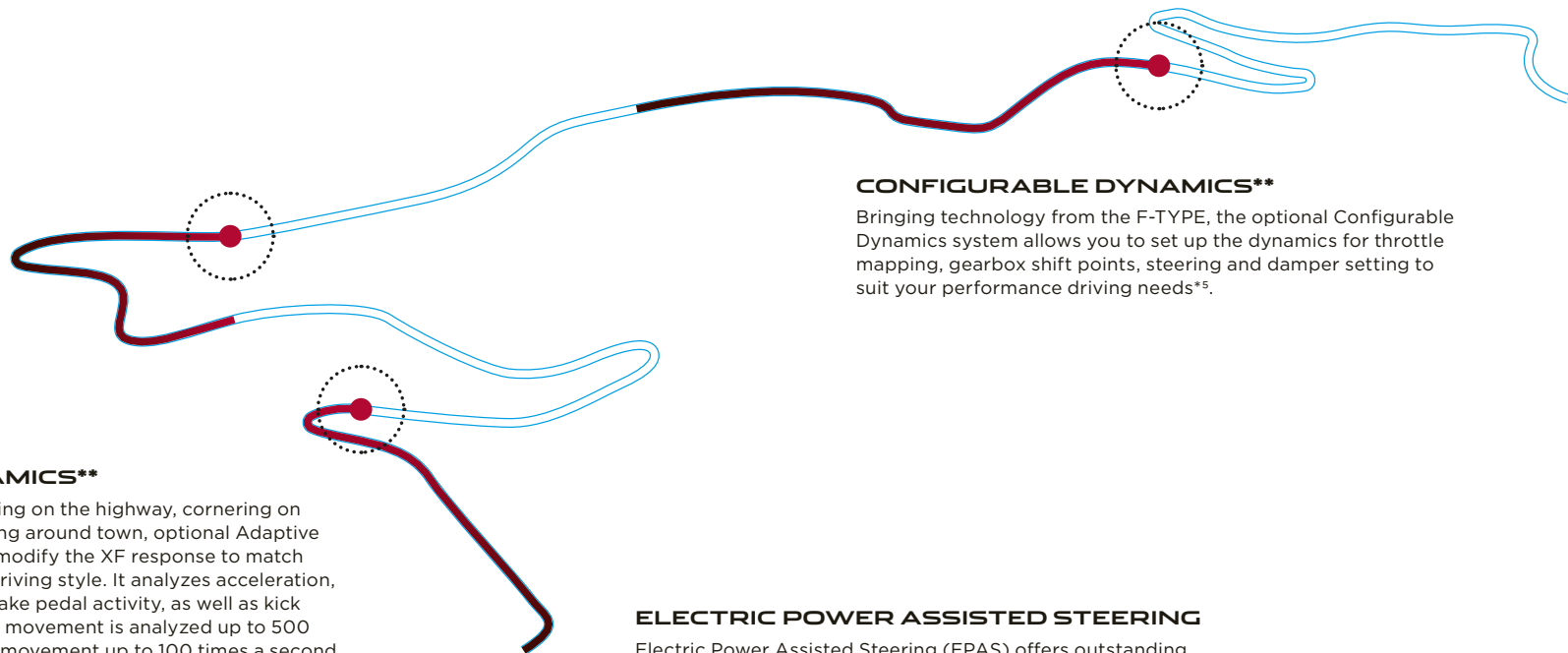

ADAPTIVE DYNAMICS**

Whether you're accelerating on the highway, cornering on country roads or navigating around town, optional Adaptive Dynamics is designed to modify the XF response to match the conditions and your driving style. It analyzes acceleration, cornering, throttle and brake pedal activity, as well as kick down activation. Steering movement is analyzed up to 500 times a second and body movement up to 100 times a second. Using this information, electronically controlled adaptive dampers then constantly adjust the suspension settings and maintain the poise and comfort of the XF*⁵.

CONFIGURABLE DYNAMICS**

Bringing technology from the F-TYPE, the optional Configurable Dynamics system allows you to set up the dynamics for throttle mapping, gearbox shift points, steering and damper setting to suit your performance driving needs*⁵.

ELECTRIC POWER ASSISTED STEERING

Electric Power Assisted Steering (EPAS) offers outstanding feedback, control and immediate power assistance. The EPAS sophisticated computer management varies steering assistance as appropriate - increasing assistance for low speed maneuvering and improving feel at higher speeds. It also enables advanced driver assistance features such as Lane Keep Assist and Park Assist*⁵.

*Please see page 103 for further information.
**Standard on XF S and Sportbrake S.



ADDED DRIVER ASSISTANCE



ALL SURFACE PROGRESS CONTROL

ADAPTIVE SURFACE RESPONSE

All Surface Progress Control (ASPC) technology is a low speed cruise control that helps the XF to cope with low traction situations. ASPC allows the driver to concentrate on steering the vehicle. Once activated, use the cruise control buttons to set a 'target' speed between 2.2 mph and 18.6 mph. The system then works to achieve and maintain that speed while exerting traction control*⁵.

ASPC is standard and gives XF drivers added assistance over slippery, loose surfaces, undulating terrain and even while descending a difficult incline. It helps make the XF easier to drive in challenging conditions. ASPC also has a pull-away function allowing the vehicle to progress from rest on low grip surfaces and ascending gradients, as well as a hill descent function that controls vehicle speed on steeper inclines*⁵.

On the XF S AWD and the XF Sportbrake S Adaptive Surface Response (AdSR) is designed to recognize differences between surfaces to exploit the maximum available grip. AdSR constantly monitors the car's environment and adjusts the appropriate engine and brake settings. Once selected, AdSR works at all speeds to support you in adverse weather and across challenging surfaces*⁵.

*Please see page 103 for further information.



GRAVEL



WET GRASS

SNOW/ICE

WET ROAD



HBS 991

XF

JAGUAR

ADVANCED DRIVETRAIN TECHNOLOGY



ALL WHEEL DRIVE

INTELLIGENT DRIVELINE DYNAMICS

The XF All Wheel Drive (AWD) system combines the agility and character of Rear Wheel Drive (RWD) with the increased security and traction provided by AWD. In normal driving, the XF is predominantly RWD to deliver handling purity, feel and balance. But when roads become more challenging, or when you accelerate more swiftly on low-grip surfaces, the system is designed to subtly channel power forwards enabling the XF to maintain improved traction for comfortable progress in various conditions*⁵.

The XF AWD uses a transfer case at the back of the 8-speed Automatic Transmission to manage the appropriate distribution of torque to the front and rear wheels. Engineered to ensure that the XF retains the dynamic behavior of a Jaguar car, the transfer case contains an electro-mechanically activated multi-plate clutch with an actuator to build hydraulic pressure. This pressure is quickly and accurately controlled to generate the required force in the clutch to transfer the optimal amount of torque to the front wheels.

Unlike other systems that react to wheel slip, Jaguar's Intelligent Driveline Dynamics (IDD) software is predictive and uses sensors measuring throttle and steering inputs to anticipate wheel slip*⁵. IDD seamlessly co-ordinates these inputs and compares them with responses from the engine, transmission and traction control systems to calculate the traction available and distribute torque accordingly even before grip is lost. From a standstill, the XF can transition from RWD to AWD in milliseconds. The result is a drive which blends the character of RWD with the capability of AWD, providing enhanced levels of performance and control*⁵.

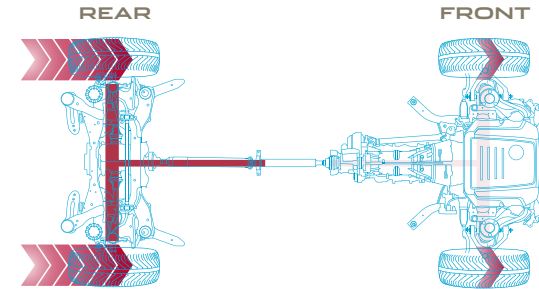

DRY ROAD CONDITIONS

In normal conditions, torque is distributed to the rear wheels, delivering acclaimed Jaguar agility and handling.

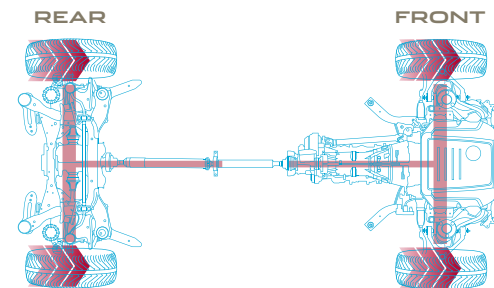

LOW TRACTION CONDITIONS

On slippery surfaces, such as grass or snow, torque can be balanced between the front and rear wheels to improve traction. In extreme conditions where only the front wheels have traction, up to 100 percent of engine torque can be distributed to the front wheels for more optimal grip.

*Please see page 103 for further information.

VEHICLE SHOWN: XF SEDAN S IN YULONG WHITE WITH OPTIONAL EQUIPMENT



TORQUE VECTORING

➤ ENHANCED CORNERING CAPABILITY

Torque Vectoring is designed to improve capability through even the tightest corners. Torque Vectoring technology provides controlled independent braking on the individual inside front and rear wheels to add to the turning forces acting on the car. In most conditions more braking pressure is applied to the rear inside wheel as this supports increased cornering capability, while the front inside wheel is braked for greater effectiveness and refinement. The result is reduced understeer for sharper turning and more consistent road holding. Torque Vectoring delivers increased sports car-like agility and added driver assistance*⁵.

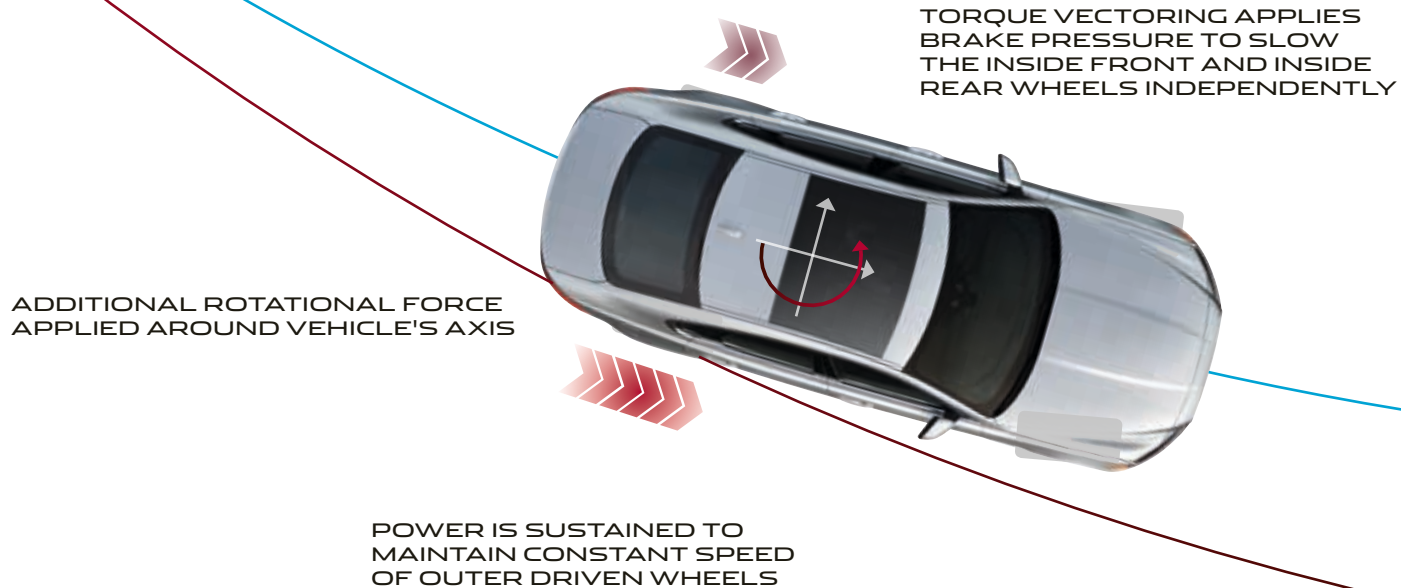

*Please see page 103 for further information.

VEHICLE SHOWN: XF SEDAN S IN YULONG WHITE WITH OPTIONAL EQUIPMENT



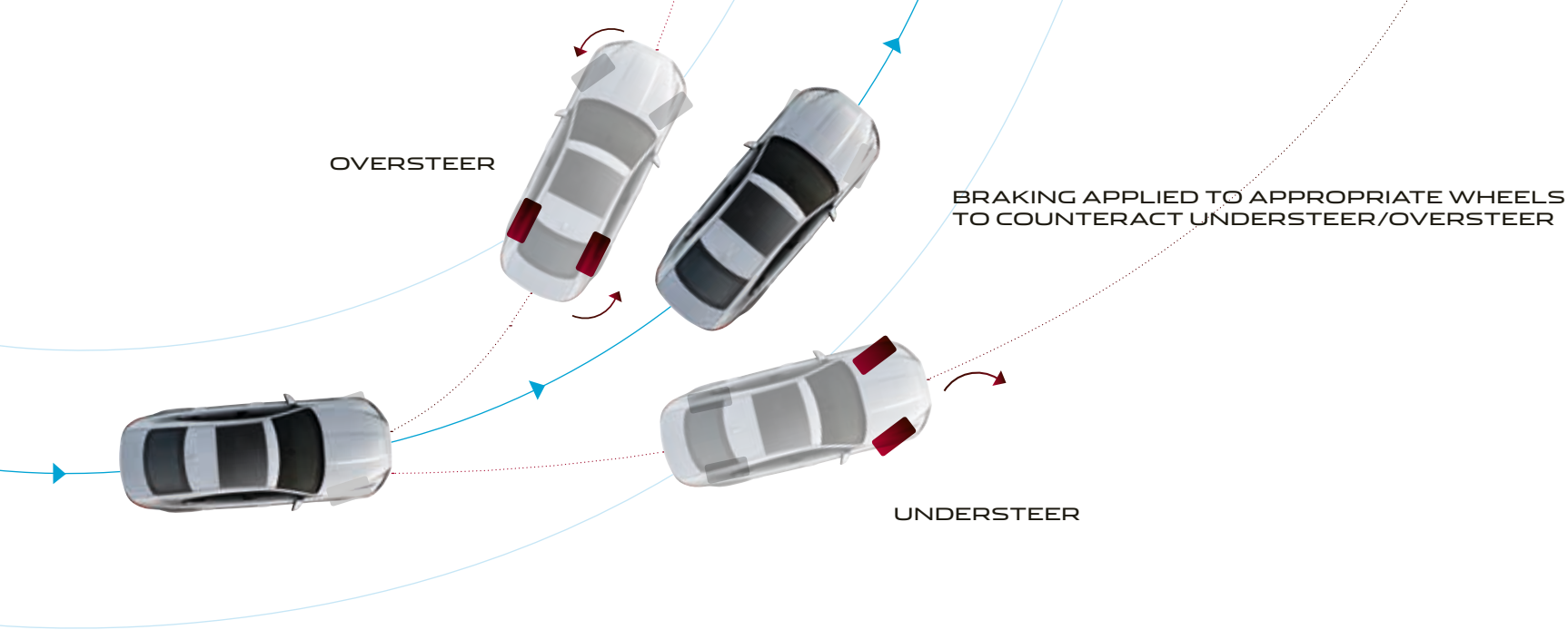

STABILITY AND CONTROL



DYNAMIC STABILITY CONTROL

ENGINE DRAG TORQUE CONTROL

The stability systems are designed to keep the XF balanced whether you're driving enthusiastically or simply want some reassurance in challenging conditions.

Dynamic Stability Control (DSC) monitors the dynamic behavior of the XF, intervening to assist vehicle stability and improving available grip. DSC is designed to reduce engine torque and apply braking to the appropriate wheels to correct the car direction of travel by counteracting understeer or oversteer. The DSC system fitted to the XF has enhanced understeer control to reduce speed and help regain control more effectively*⁵.

Engine Drag Torque Control mitigates the chance of wheel lock-up caused by strong engine braking in slippery conditions. It acts by briefly increasing torque to the driven wheels as appropriate*⁵.

*Please see page 103 for further information.

Graphical representation only.

VEHICLE SHOWN: XF SEDAN S IN YULONG WHITE WITH OPTIONAL EQUIPMENT



60 mph
55 mph
60 mph

Darkness
Oliver Daldry
Darkness
6/12



5:06 PM

59°F

SET +



HEAD-UP DISPLAY

> HEAD-UP DISPLAY WITH LASER TECHNOLOGY

The optional Head-up Display with laser technology projects key information onto the windshield. Remaining clear even in direct sunlight, the crisp, bright image can display vehicle speed, navigation, cruise control notifications and Traffic Sign Recognition data, where available. This technology helps you minimize time spent looking down at the instrument cluster and can help you maintain continuous awareness of your speed*⁵.

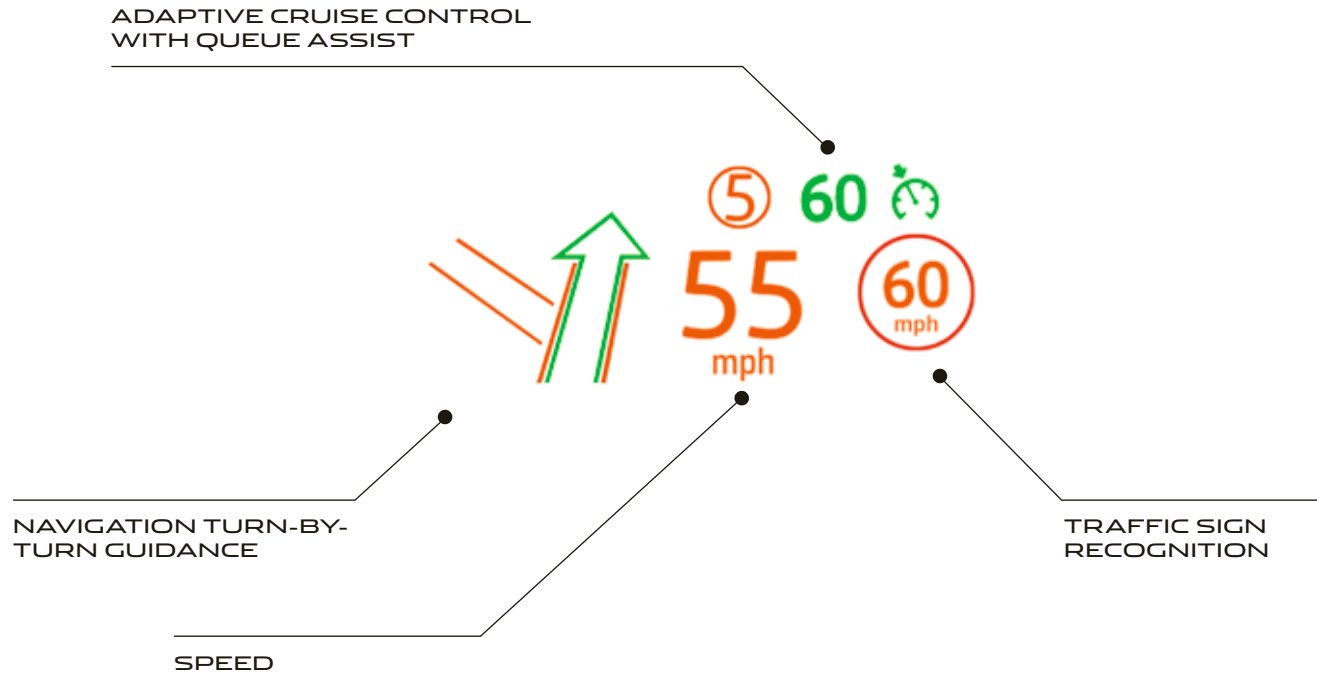

*Please see page 103 for further information.

INTERIOR SHOWN LEFT FEATURES OPTIONAL TECHNOLOGY PACKAGE

JAGUAR INCONTROL® TECHNOLOGIES INFOTAINMENT AND TECHNOLOGY



Jaguar InControl is our suite of advanced technologies that links both you and your XF to the wider world. Choose from two Jaguar InControl® infotainment systems: Touch, available as standard, or upgrade to Touch Pro*1.

*Please see page 103 for further information.

As we roll out InControl®, specific features described may be optional, and market or powertrain dependent. Please visit jaguarusa.com/owners/incontrol or your local Jaguar Retailer for availability and full terms. Certain features require an appropriate SIM with a suitable data contract which will require further subscription after the initial term advised by your Retailer. Mobile connectivity cannot be guaranteed in all locations.

Third Party programs or applications may require an end user license from the supplier.



TOUCH*1



STANDARD ON EVERY XF

8" Touchscreen
 5" instrument panel display with analog dials
 Meridian™ Sound System (380W)
 HD Radio™, USB*8, Bluetooth® and AUX connections



Remote & Protect™ consists of
 SOS Emergency Call, Jaguar Optimized Roadside Assistance,
 Stolen Vehicle Locator and Remote smartphone app

OPTIONAL FEATURES

SD Navigation
 Wi-Fi Hotspot*3
 SiriusXM® Satellite Radio*4
 InControl Apps™

For information on Touch see pages 46-47.



TOUCH PRO*1



AVAILABLE AS AN OPTION

10" Touchscreen with multi-touch gestures
 and customizable homescreen
 12.3" instrument panel display with virtual dials
 and full screen 3D navigation map view
 Navigation Pro
 Meridian™ Surround Sound System (825W)
 2 x USB connections
 CD/DVD Drive



Remote & Protect™ consists of
 SOS Emergency Call, Jaguar Optimized Roadside Assistance,
 Stolen Vehicle Locator and Remote smartphone app

Connected Navigation consists of InControl Apps™,
 door-to-door navigation and Wi-Fi Hotspot*3

OPTIONAL FEATURES

SiriusXM® Satellite Radio*4

For information on Touch Pro see pages 48-49.

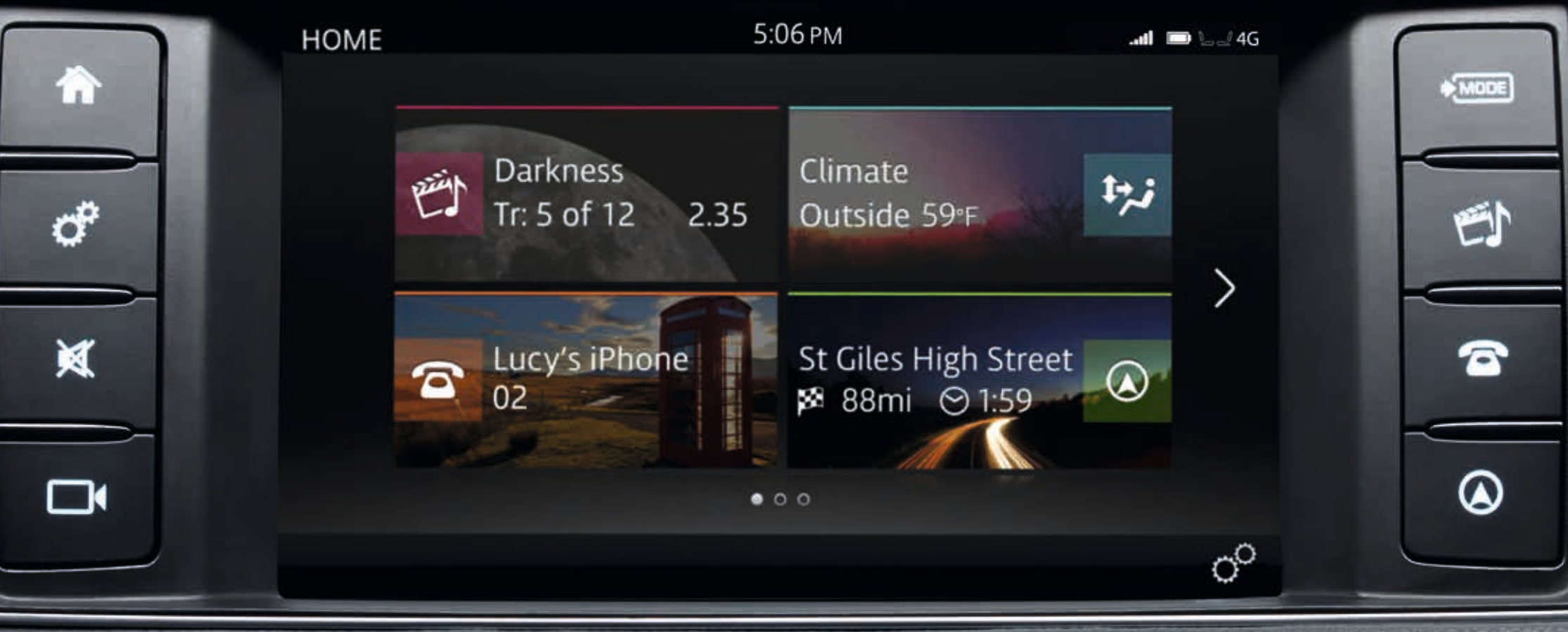

8" TOUCHSCREEN SHOWN AT ACTUAL SIZE

Audio	Meridian™ Sound System (380W)
Display	8" Touchscreen* ²
Multimedia	HD Radio™, USB* ⁸ , Bluetooth® and AUX connections
Touch Features*¹	Remote & Protect consists of SOS Emergency Call, Jaguar Optimized Assistance, Stolen Vehicle Locator and Remote smartphone app
Optional Features	Navigation with InControl Apps™* ¹ , Wi-Fi Hotspot* ³ and SiriusXM® Satellite Radio* ⁴

*Please see page 103 for further information.

TOUCH



ADVANCED INFOTAINMENT AS STANDARD

The Touch multimedia system is the hub for connectivity, control and entertainment*¹. The key features are:

8" Touchscreen at the heart of the center console. Clear and responsive graphical interface for quick control.

Easy to use Touchscreen responds directly to touch and swipe gestures.

Bluetooth phone connectivity allows you to link and control your smartphone via Touch either for phone calls or music playback: simple, easy and wire-free.

Access a world of music thanks to HD Digital Radio and available SiriusXM® Satellite Radio*⁴, as well as USB*⁸ and AUX connections.

Integrated text-to-voice technology reduces distraction by reading out incoming text messages. You can easily respond with short, prepared messages.

Precise climate control is available via the Touchscreen. Adjust temperature levels, direction and intensity of airflow and operate heated or cooled seats (if fitted).

Remote is a multi-function app that allows you to monitor as well as interact with your XF from your smartphone. Remote start the engine to pre-condition the climate, lock and unlock the car, locate your XF on a map or by using the beep and flash function, and track your journeys – all via the app.

Protect includes SOS Emergency Call and Jaguar Optimized Roadside Assistance, which can automatically bring the relevant services to your exact location if the airbags deploy.



OPTIONAL FEATURES

Enhance the capabilities of the InControl Touch™ multimedia system*¹ by selecting from the following options:

Navigation makes planning journeys and following routes easy, thanks to turn-by-turn voice guidance, intersection views and 3D maps*¹.

Wi-Fi Hotspot gives you the option to create a 4G Hotspot using the car antenna when you fit a SIM card. This strengthens your link to the outside world, for a more stable connection than an individual device could maintain. Connect up to eight devices to read emails, browse the web and download content*³.

InControl Apps™ features a range of Jaguar approved apps that can be connected to the car from your smartphone. It ensures the convenient use of these apps that have been optimized specifically to enhance aspects of your in-car experience.



Explore Jaguar InControl® at JAGUARUSA.COM

As we roll out InControl®, specific features described may be optional or powertrain dependent. Please consult your country-specific Jaguar website or local Jaguar Retailer for availability and full terms in your country. Certain features require an appropriate SIM with a suitable data contract which will require further subscription after the initial term advised by your Retailer. Mobile connectivity cannot be guaranteed in all locations.



10" TOUCHSCREEN SHOWN AT ACTUAL SIZE

Audio	Meridian™ Surround Sound System (825W)
Navigation Guidance*¹	Navigation Pro
Display*²	10" Touchscreen
Multimedia*²	Bluetooth®, HDMI, 2 x USB* ⁸ connections, and CD/DVD Drive
Touch Pro Features*¹	<p>Remote & Protect consists of SOS Emergency Call, Jaguar Optimized Roadside Assistance, Stolen Vehicle Locator and Remote smartphone app.</p> <p>Connected Navigation consists of InControl Apps™, Wi-Fi Hotspot*³ and additional services including Route Planner Companion App, share your destination and ETA, Commute Mode, Arrival Mode, real time traffic information and fuel and parking services.</p>



12.3" Full Digital Instrument Panel with virtual dials

*Please see page 103 for further information.

TOUCH PRO

UPGRADE TO NEXT GENERATION INFOTAINMENT

The next-generation hardware and software of Touch Pro advances your vehicle connectivity and entertainment to the very highest level. The key features of the Touch Pro system are*¹:

Larger, highly-responsive, 10" Touchscreen at the heart of the center console with customizable homescreen and improved fast response times. Its interactive side panel makes multi-tasking easy.

Pinpoint touch control allows you to manipulate and interact with information swiftly and seamlessly. The Touchscreen responds in the same manner as a smartphone or tablet computer, providing multi-touch gestures such as pinch to zoom and swipe.

12.3" instrument panel display with virtual dials and full screen 3D map view makes driving even more of a pleasure. It is housed in the instrument display directly in front of the driver. Select full screen 3D map view or choose one of four graphical themes to suit your personal preference.

Navigation Pro offers as one of its many innovative features the ability to set a destination and the system alerts you if you have insufficient fuel for the journey. It then displays filling stations on the part of the route where you may be low on fuel. The system automatically displays parking options.

 Explore Jaguar InControl® at JAGUARUSA.COM

As we roll out InControl®, specific features described may be optional or powertrain dependent. Please consult your country-specific Jaguar website or local Jaguar Retailer for availability and full terms in your country. Certain features require an appropriate SIM with a suitable data contract which will require further subscription after the initial term advised by your Retailer. Mobile connectivity cannot be guaranteed in all locations.

ENHANCED CONNECTIVITY

The services, technologies and applications found within Connected Navigation provide you with the very best in connectivity and convenience*¹. It offers many features including:

Route Planner Companion App offers true door-to-door navigation. Pre-plan your destination and route via your Apple® or Android™ smartphone. The app will guide you to your car, where you will find your selected route available on the car Touchscreen. When you've completed your road trip, the app can guide you by foot or public transportation (where supported) to your destination.

Share your estimated time of arrival so your selected contact(s) will know exactly when you will arrive, as calculated by the navigation guidance system. If you're running late, the system can then send automatic updates via text or email, without any further action from you.

Commute Mode allows the system to learn your commutes and automatically advises you of the expected travel time based on live and historical traffic movements. The system learns the routes you take for a given destination and then advises which of those is the quickest.

Arrival Mode displays interactive 360 degree street level imagery of your destination for seamless finishes to driving trips. It automatically displays again upon your arrival. You can simply tap the touchscreen to select a nearby parking garage, which appears as an updated destination.



AUDIO

MERIDIAN™ SOUND SYSTEMS

The XF offers an exceptional listening experience with a choice of two Meridian Sound Systems. Designed in conjunction with the British audio experts Meridian, these systems use innovative audio technology and precise speaker placement to give perfectly optimized sound quality.

The superb Meridian 380W Sound System has 11 speakers and is standard on all XF models. The optional 825W Surround Sound System has 17 speakers which ensure that, wherever you or your passengers sit in the XF, everyone will enjoy a rich, enveloping audio experience.



-  Fresh air subwoofer
-  Front door waves tweeter midrange bass
-  Rear door waves tweeter midrange

Diagram representative of Meridian™ 380W Sound System.



MERIDIAN

SOUND SYSTEM AVAILABLE IN CONJUNCTION WITH **TOUCH**

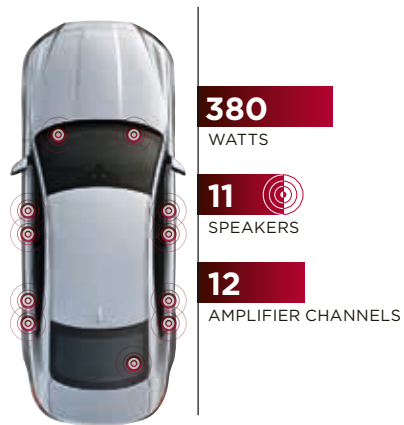

**MERIDIAN
SOUND SYSTEM**

DSP amplifier
Speed Dependent Volume
380 watts
11 speakers
12 amplifier channels

SOUND SYSTEM AVAILABLE IN CONJUNCTION WITH **TOUCH PRO**

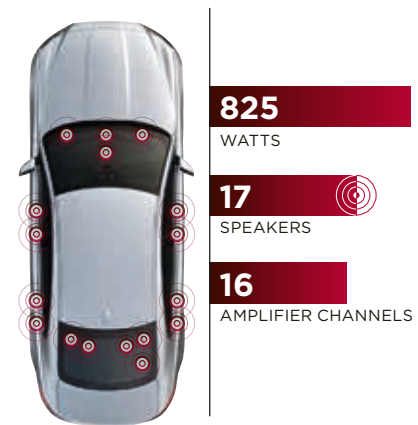

**MERIDIAN
SURROUND SOUND SYSTEM**

DSP amplifier
Audyssey MultEQ Audio Equalization
Dynamic Volume Control
825 watts
17 speakers
16 amplifier channels

Graphical representations only. Indicative of speaker positions in both XF Sedan and XF Sportbrake.

DRIVER ASSISTANCE

ADVANCED DRIVER ASSISTANCE



- 1 **EMERGENCY BRAKING****
Should a potential collision be detected, the XF gives an audible forward collision warning. Visual warnings follow. If the driver takes no action the system is designed to apply the brakes to help reduce the severity of the possible impact when driving below 50 mph. This system also includes pedestrian sensing*⁵.

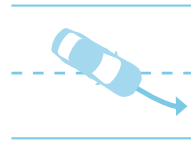

- 2 **LANE DEPARTURE WARNING****
Lane Departure Warning notifies the driver with a visual alert and a gentle vibration of the steering wheel should the car detect an unintentional drift from its lane*⁵.



- 3 **LANE KEEP ASSIST AND DRIVER CONDITION MONITOR****
Lane Keep Assist is designed to sense unintentional lane drift and to help steer the XF back into its lane. Driver Condition Monitor is designed to detect lapses in concentration due to tiredness by monitoring driver inputs and suggests taking a break via an audible alert and a visual notification in the instrument cluster*⁵.

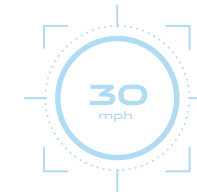

- 4 **TRAFFIC SIGN RECOGNITION WITH INTELLIGENT SPEED LIMITER****
Traffic Sign Recognition (TSR) technology detects speed limits, including variable limits, and no passing signs via the forward-facing camera, then displays them to the driver. The Intelligent Speed Limiter uses TSR's information, supported by map data from the navigation system, to help keep the XF within the appropriate speed limit*⁵.

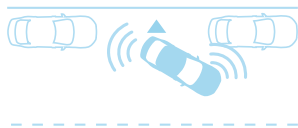

- 5 **PARK ASSIST****
Park Assist makes parking in tight spaces easier than ever. The XF can accurately steer itself during both parallel and perpendicular parking maneuvers - the driver only has to control the brakes and accelerator. An exit-assist function can help guide the XF while leaving a parallel space*⁵.



- 6 **BLIND SPOT ASSIST AND REVERSE TRAFFIC DETECTION****
If your car detects another vehicle in or quickly approaching your blind spot, the Blind Spot Monitor system is designed to alert you via a small warning light in the corresponding exterior mirror. As an enhancement to this feature, Blind Spot Assist will apply steering torque to guide you away from the vehicle in your blind spot if you begin to change lanes. Using the same radar system, Reverse Traffic Detection is designed to alert you via the Touchscreen of moving vehicles during reversing - for example, when leaving a parking spot with restricted vision*⁵.

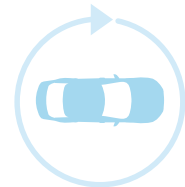

- 7 **SURROUND CAMERA SYSTEM****
Helping with various maneuvers, from parking by a curb to getting in and out of tight spaces or intersections, Surround Camera System gives you 360° exterior vision on the Touchscreen. To enhance this system further, new Forward Vehicle Guidance and Forward Traffic Detection are also available. Forming part of the Surround Camera System, Forward Vehicle Guidance provides the driver with an on-screen visualization of the vehicle and parking distance. Forward Traffic Detection helps avoid potential collisions in situations where forward maneuvers involve restricted views*⁵.

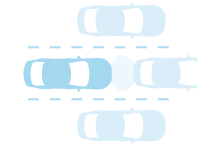

- 8 **ADAPTIVE CRUISE CONTROL WITH QUEUE ASSIST****
Adaptive Cruise Control uses radar technology to automatically adjust your speed to maintain a set distance from the vehicle ahead. If that vehicle slows, your XF reduces its speed to maintain a set distance. The XF resumes its pre-set speed as soon as the road in front is clear. Should the car in front stop completely, the Queue Assist function is designed to help bring the XF to a smooth halt. Once the traffic moves, touch the accelerator and the XF will follow the car in front again*⁵.

*Please see page 103 for further information.

**Optional feature.

VEHICLE SHOWN: XF SEDAN PRESTIGE IN INDUS SILVER WITH OPTIONAL EQUIPMENT

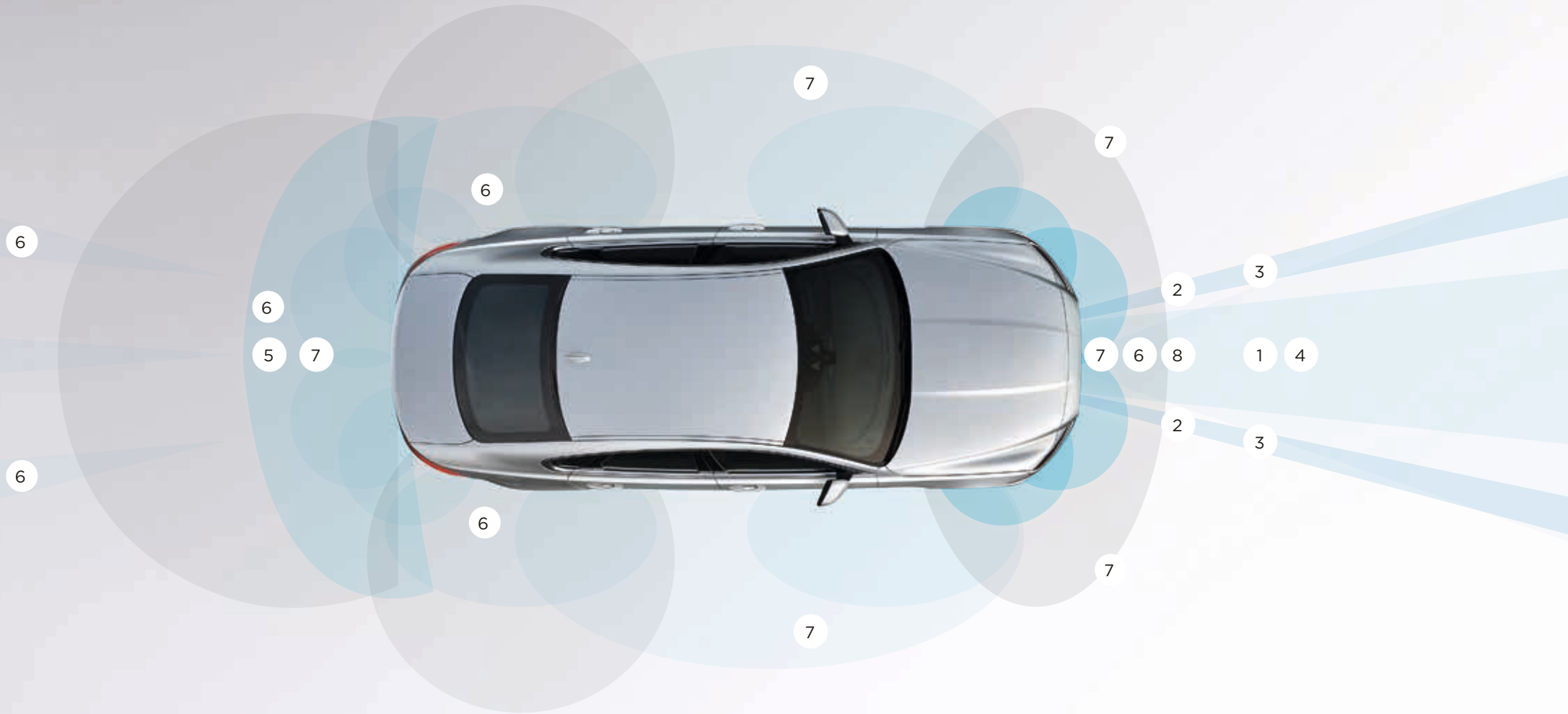

Graphical representation only.

PERSONALIZATION THE XF - YOUR CHOICE

 Configure your vehicle at JAGUARUSA.COM



CHOOSE YOUR ENGINE

Page 56

Select your XF engine,
to suit your driving style.

CHOOSE YOUR MODEL & PACKAGES

Page 58

Compare the wealth of standard
features and options on the XF models.

CHOOSE YOUR COLOR

Page 66

Express your individuality with
one of the stunning exterior colors
available on the XF.

CHOOSE YOUR WHEELS

Page 68

Add the personal finishing touch to your new XF, and complement its stunning style, with a set of beautifully designed alloy wheels.

CHOOSE YOUR INTERIOR

Page 70

There's a wide selection of premium materials, leathers, veneers and finishes for every personal taste.

CHOOSE YOUR JAGUAR GEAR

Page 84

Really make it yours by adding style, practicality and versatility with official XF Gear Accessories from your local Jaguar Retailer.

1 CHOOSE YOUR ENGINE

 Configure your vehicle at JAGUARUSA.COM

DIESEL ENGINES

2.0 LITER 4 CYLINDER TURBOCHARGED

XF SEDAN

MAXIMUM POWER 180HP

MAXIMUM TORQUE 318 lb-ft

ACCELERATION 0-60

RWD 8.0 seconds / AWD 7.9 seconds*7

TOP SPEED 121 mph*7

XF, PREMIUM, PRESTIGE, R-SPORT



RWD 0-60 MPH



AWD 0-60 MPH



TOP SPEED MPH



TOP SPEED MPH

*Please see page 103 for further information.

> GAS ENGINES

2.0 LITER

4-CYLINDER TURBOCHARGED

XF SEDAN

MAXIMUM POWER 247HP

MAXIMUM TORQUE 269 lb-ft

ACCELERATION 0-60

RWD 6.3 seconds / AWD 6.2 seconds*

TOP SPEED 121 mph**

XF, PREMIUM, PRESTIGE, R-SPORT



RWD 0-60 MPH



AWD 0-60 MPH



TOP SPEED MPH



TOP SPEED MPH

2.0 LITER

4 CYLINDER TURBOCHARGED

XF SEDAN

MAXIMUM POWER 296HP

MAXIMUM TORQUE 295 lb-ft

ACCELERATION 0-60

RWD 5.6 seconds / AWD 5.5 seconds*

TOP SPEED 121 mph**

PREMIUM, PRESTIGE, PORTFOLIO



RWD 0-60 MPH



AWD 0-60 MPH



TOP SPEED MPH



TOP SPEED MPH

3.0 LITER V6

SUPERCHARGED

XF SEDAN

MAXIMUM POWER 380HP

MAXIMUM TORQUE 332 lb-ft

ACCELERATION 0-60

RWD 5.1 seconds / AWD 5.0 seconds*

TOP SPEED 121 mph**

S

XF SPORTBRAKE

MAXIMUM POWER 380HP

MAXIMUM TORQUE 332 lb-ft

ACCELERATION 0-60 mph

AWD 5.3 seconds*

TOP SPEED 121 mph**

S



RWD 0-60 MPH



AWD 0-60 MPH



TOP SPEED MPH



TOP SPEED MPH



AWD 0-60 MPH



TOP SPEED MPH

2 CHOOSE YOUR MODEL & PACKAGES

 Configure your vehicle at JAGUARUSA.COM

LUXURY



XF

KEY FEATURES

18" alloy wheels
 Bi-function Xenon headlights with LED 'J' blade and power wash
 Luxtec seats
 10-way front seats (8-way electric)
 Gloss Black veneer
 Morse Code Aluminum instrument panel finisher
 Meridian 380W Sound System
 All Surface Progress Control (ASPC)*⁵



PREMIUM

KEY FEATURES (IN ADDITION TO XF)

Driver seat memory
 Rear Camera Parking Aid with guidance lines on display*⁵
 Memory, Power folding electrically adjustable, heated exterior mirrors
 Rear-folding seat (40/20/40 split)
 Power adjustable steering column



PRESTIGE

KEY FEATURES (IN ADDITION TO PREMIUM)

19" alloy wheels
 Grained leather seats
 Soft grain leather heated steering wheel
 Heated front seats with 4-way power lumbar
 Interior Mood Lighting
 Keyless Entry
 Front and Rear Parking Aid*⁵
 Navigation*²



PORTFOLIO

KEY FEATURES (IN ADDITION TO PRESTIGE)

Windsor leather 20-way electric front luxury Seats
 Windsor leather wrapped instrument panel
 Heated and cooled front seats with heated rear seats
 LED headlights with LED signature 'J' blade DRL and Auto High Beam Assist (AHBA)
 Blind Spot Monitor and Reverse Traffic Detection
 Electric rear, manual side window sunblinds
 InControl Touch Pro™ Navigation
 12.3" Full digital Instrument Panel
 Meridian 825W Surround Sound System
 Head-up Display
 Powered Gesture Trunk Lid

*Please see page 103 for further information.

> SPORT



R-SPORT

KEY FEATURES (IN ADDITION TO PRESTIGE)

'R-Sport' body kit including sport front bumper, body-colored side sills and trunk mounted spoiler
Grained leather sport-style seats
Metal treadplates and multi-function steering wheel with 'R-Sport' branding
Gloss Black side window surround
Dark Morse Code Aluminum instrument panel finisher
LED headlights with Auto High Beam Assist*⁵
Lane Keep Assist with Driver Condition Monitor*⁵
Blind Spot Assist with Reverse Traffic Detection*⁵



S

KEY FEATURES (IN ADDITION TO R-SPORT)

20" alloy wheels
'S' body kit including unique front sport bumper, Gloss Black side sills, rear valance and trunk mounted spoiler
Red brake calipers
18-way electric front sport-style seats
Taurus leather 'S' embossed seats
Grey Figured Ebony veneer
Dark Hex Aluminum instrument panel finisher
Metal treadplates and multi-function steering wheel with 'S' branding
Adaptive Dynamics*⁵ and Configurable Dynamics

SPORTBRAKE KEY FEATURES (IN ADDITION TO XF S SEDAN)

Gloss Black Roof Rails
Integrated Roof Spoiler
Rear Self Leveling Air Suspension
Cargo Space Cover
Powered Gesture Tailgate
Stainless steel cargo space scuff plate

2 CHOOSE YOUR MODEL & PACKAGES

 Configure your vehicle at JAGUARUSA.COM

KEY STANDARD & OPTIONAL FEATURES

	XF	PREMIUM	PRESTIGE	PORTFOLIO	R-SPORT	S
TRANSMISSION, STEERING & DYNAMIC FEATURES						
8-speed ZF electronic Automatic Transmission	●	●	●	●	●	●
Electric Power Steering (EPAS) with speed proportional steering* ⁵	●	●	●	●	●	●
Torque Vectoring* ⁵	●	●	●	●	●	●
Hill Launch Assist* ⁵	●	●	●	●	●	●
All Surface Progress Control (ASPC)* ⁵	●	●	●	●	●	●
Steering wheel mounted shift paddles	●	●	●	●	●	●
JaguarDrive Control™	●	●	●	●	●	●
Normal, Eco & Dynamic Modes* ⁵	●	●	●	●	●	●
Rain/Ice/Snow Mode* ⁵	●	●	●	●	●	●
Adaptive Surface Response (AdSR) Mode* ⁵ (XF S AWD model only)	●	●	●	●	●	●
JaguarDrive Selector™ rotary gear selector	●	●	●	●	●	●
SUSPENSION						
Four-wheel independent suspension	●	●	●	●	●	●
Double wishbone front suspension architecture	●	●	●	●	●	●
Integral link rear suspension	●	●	●	●	●	●
Rear Air Suspension Architecture	—	—	—	—	—	● [†]
Sport suspension (Spring & damper upgrade)	—	—	—	—	●	●
Adaptive Dynamics with Configurable Dynamics (with InControl Touch) or Dynamic-i* ⁵ (with InControl Touch Pro)	—	—	○	○	○	●
BRAKES & STABILITY CONTROL						
Anti-lock Braking System (ABS)* ⁵	●	●	●	●	●	●
Cornering Brake Control (CBC)* ⁵	●	●	●	●	●	●
Dynamic Stability Control (DSC) with Trac DSC Mode* ⁵	●	●	●	●	●	●
Electric Parking Brake (EPB) with drive away release	●	●	●	●	●	●
Hazard lights under heavy braking	●	●	●	●	●	●

SAFETY & SECURITY

	XF	PREMIUM	PRESTIGE	PORTFOLIO	R-SPORT	S
SAFETY						
Passive front head restraints (whiplash reduction system)	●	●	●	●	●	●
Seat belt-minder system with audio reminder chime and flashing warning light engages if vehicle is moving more than 10 mph and safety belt is not buckled on occupied front or rear seats	●	●	●	●	●	●
Driver and front passenger safety belt pretensioners	●	●	●	●	●	●
ISOFIX child seat tethered-anchorage	●	●	●	●	●	●
Dual-stage front airbags and seat-mounted side airbags for front occupants* ⁶	●	●	●	●	●	●
Full length side-impact curtain airbags* ⁶ for front and rear	●	●	●	●	●	●
Three-point restraints at all seating positions	●	●	●	●	●	●
Tire Pressure Monitoring System (TPMS)	●	●	●	●	●	●
SECURITY						
Anti-theft engine immobilizer	●	●	●	●	●	●
Security system with perimeter alarm	●	●	●	●	●	●
Emergency phosphorescent release in trunk	●	●	●	●	●	●
Brake pad wear indicator	●	●	●	●	●	●
LOCKING						
2-stage unlock, Touchscreen programmable	●	●	●	●	●	●
Central locking with drive-away door locking (Touchscreen programmable)	●	●	●	●	●	●
Jaguar Smart Key System™ with emergency blade - provide remote locking/unlocking, access to trunk and activate panic alarm	●	●	●	●	●	●
Keyless Entry	—	○	●	●	●	●
Soft Door Close	—	—	P3	●	P3	P3
Power gesture tailgate - power open/close	—	—	P3	●	P3	P3 [†]
Power operated child locks	●	●	●	●	●	●
Global window close from exterior lock button	●	●	●	●	●	●
Valet function for glove box and trunk security	●	●	●	●	●	●

● Standard ○ Option — Not available

P1 Cold Climate Package P2 Vision Package P3 Comfort & Convenience Package P4 Luxury Interior Upgrade Package P5 Driver Assistance Package P6 Technology Package P7 Black Package

*Please see page 103 for further information.

**Sport suspension only standard on the 2.0L diesel RWD.

†Only standard on XF Sportbrake.

DRIVERS AIDS*5

	XF	PREMIUM	PRESTIGE	PORTFOLIO	R-SPORT	S
Cruise control	●	●	●	●	●	●
Automatic Speed Limiter. If Traffic Sign Recognition is fitted on the vehicle, the Adaptive Speed Limiter (ASL) replaces the Automatic Speed Limiter	●	●	●	●	●	●
Blind Spot Monitor with Closing Vehicle Sensing	—	P2	P2	●	●	●
Blind Spot Assist	—	—	—	P5	P5	P5
Reverse Traffic Detection	—	P2	P2	●	●	●
Rear Camera Parking Aid with guidance lines on display	○	●	●	●	●	●
Rear parking sensors with Touchscreen visual indicators	—	P2	●	●	●	●
Front parking sensors with Touchscreen visual indicators	—	P2	●	●	●	●
Proximity Camera System - 4 cameras for front, side and rear views with images shown on the Touchscreen	—	—	—	P5	P5	P5
Park Assist - Parallel and Perpendicular Parking plus Parking Exit	—	—	—	P5	P5	P5
360° Parking Aid - additional sensors to alert the driver to potential side impacts	—	—	—	P5	P5	P5
Traffic Sign Recognition and Adaptive Speed Limiter (ASL) (ASL replaces the cruise control's Automatic Speed Limiter)	—	—	—	P5	P5	P5
Adaptive Cruise Control (ACC) with Forward Alert, Queue Assist, Intelligent Emergency Braking and Follow Mode off (When ACC fitted, the front grille insert is Gloss Black)	—	—	—	P5	P5	P5
Emergency Braking (uses forward facing camera)	—	P2	P2	●	●	●
Lane Departure Warning	—	—	—	●	●	●
Lane Keeping Assist	—	—	—	●	●	●
Driver Condition Monitor	—	—	—	●	●	●
Head-up Display	—	—	○	●	○	○

CONVENIENCE FEATURES

	XF	PREMIUM	PRESTIGE	PORTFOLIO	R-SPORT	S
Approach illumination	●	●	●	●	●	●
Dual function trip computer in Driver Message Center	●	●	●	●	●	●
Outside temperature gauge	●	●	●	●	●	●
Lockable glove box	●	●	●	●	●	●
A/C ducts in glove box for cooling	—	—	—	●	P4	P4
HomeLink® System - compatible three-channel garage-door/entry-gate opener	●	●	●	●	●	●
Keyless Push Button Start	●	●	●	●	●	●
Rain sensing, variable intermittent dual wipers	●	●	●	●	●	●
Shopping bag hook and luggage tie downs in trunk	●	●	●	●	●	●
Sunglasses holder in overhead console	●	●	●	●	●	●
Three 12V power sockets - center cubby box, rear of center arm rest and right hand trunk wall	●	●	●	●	●	●

2 CHOOSE YOUR MODEL & PACKAGES

Configure your vehicle at JAGUARUSA.COM

EXTERIOR FEATURES

	XF	PREMIUM	PRESTIGE	PORTFOLIO	R-SPORT	S
BODY EXTERIOR APPEARANCE						
Bumpers - Body-colored	●	●	●	●	●	●
Exhaust tips - Twin single sided	●(1)	●(1)	●(1)	—	●(1)	—
Exhaust tips - Dual bright	—	●(2)	●(2)	●(2)	●(2)	●(2)
Front grille	Grained Black mesh insert with Bright Chrome surround	●	●	●	—	—
	Gloss Black mesh insert with bright chrome surround	—	—	—	P5	—
	Grained Black mesh insert with Satin Chrome surround	—	—	—	—	●
	Gloss Black mesh insert with Satin Chrome surround	—	—	—	—	P5
	Gloss Black mesh insert with Gloss Black surround	—	—	—	—	—
Window surround finishers	Bright Chrome	●	●	●	—	—
	Gloss Black	—	—	—	—	●
Trunk plinth finisher	Bright Chrome	●	●	●	—	—
	Satin Chrome	—	—	—	—	●
Side power vents	Bright Chrome	●	●	●	—	—
	Satin Chrome	—	—	—	—	●
Front bumper	Sport style front bumper	—	—	—	—	●
	'S' Style Bumper	—	—	—	—	●
Side sills	Body Colored	—	—	—	—	●
	Gloss Black	—	—	—	—	●
Rear valance	Grained Black	●	●	●	●	—
	Gloss Black	—	—	—	—	●
Rear spoiler - Body-colored, trunk mounted	—	—	—	—	●	●
Full Length Gloss Black Roof Rails (only available on XF Sportbrake)	—	—	—	—	—	●

EXTERIOR BADGING

	XF	PREMIUM	PRESTIGE	PORTFOLIO	R-SPORT	S
Trunk left side - Nameplate	●	●	●	●	●	●
Center trunk lid - Jaguar and leaper wordmark	●	●	●	●	●	●
Trunk right side	Powertrain badging '20d' with 20d models only	●	●	●	—	—
	Powertrain badging '25t' with 25t models only	●	●	●	—	—
	Powertrain badging '35t' with 35t models only	—	●	●	●	—
	'S' badging	—	—	—	—	●
'AWD' badging with AWD models only	●	●	●	●	●	●
Side power vents - 'R-Sport'	—	—	—	—	●	—
Front grille - 'S' Script	—	—	—	—	—	●

BRAKE CALIPERS

Red with 'Jaguar' script (word is in silver)	—	—	—	—	—	●
--	---	---	---	---	---	---

ELECTRIC GLASS MOONROOF

Electric with tilt/slide one-touch operation and electric blind (only available on XF Sedan)	●	●	●	●	●	●
Fixed Panoramic Roof (only available on XF Sportbrake)	—	—	—	—	—	●

LIGHTS

Bi-function HID Xenon headlights with auto-leveling and auto on/off	●	●	●	—	—	—
Full LED headlights	—	P2	P2	●	●	●
LED signature 'J' blades Daytime Running Lights	●	●	●	●	●	●
Headlight power wash	●	●	●	●	●	●
Adaptive Front Lighting*5	—	P2	P2	●	●	●
Cornering Lights*5	—	P2	P2	●	●	●
Auto High Beam Assist (AHBA)*5	—	P2	P2	●	●	●
Partial Light Emitting Diode (LED) tail lights	●	●	●	●	●	●

MIRRORS & WINDOWS

Exterior mirrors - body-colored, electrically adjustable, heated with clear side turn indicators	●	—	—	—	—	—
Exterior mirrors - body-colored, power folding, electrically adjustable, heated, electrochromic with puddle lights and clear side turn indicators	—	●	●	●	●	●
Passenger side exterior mirror - dip in reverse	—	●	●	●	●	●

● Standard ○ Option — Not available

P1 Cold Climate Package P2 Vision Package P3 Comfort & Convenience Package P4 Luxury Interior Upgrade Package P5 Driver Assistance Package P6 Technology Package P7 Black Package

*Please see page 103 for further information.

(1)Standard on 20d models. (2)Standard on 25t and 35t models.

INTERIOR FEATURES

	XF	PREMIUM	PRESTIGE	PORTFOLIO	R-SPORT	S
CLIMATE CONTROL						
Front deployable vents	●	●	●	●	●	●
Automatic A/C with solar sensing, mist sensing, air filtration and dual temperature control for driver and front passenger	●	●	●	—	●	●
Four-zone Climate Control with auto-recirculation and air ducts in glove box. (Four-zone fitment results in replacement of the center console storage with a tray)	—	—	—	●	P4	P4
DOOR SILL FINISHERS						
Metal with Jaguar script	●	●	●	—	—	—
Metal with 'R-Sport' script	—	—	—	—	●	—
Metal with 'S' script	—	—	—	—	—	●
Illuminated - Metal with Jaguar script	—	—	—	●	P4	P4
FOOTWELL RUGS						
Front and rear carpet mats	●	●	●	—	●	●
Premium front and rear floor mats (with Nubuck edge and tonal twin-needle stitching)	—	—	—	●	P4	P4
GEAR SELECTOR						
JaguarDrive™ rotary gear selector - Bright Chrome finish	●	●	●	●	●	●
INTERIOR LIGHTING						
Overhead light console with JaguarSense™ Control	●	●	●	●	●	●
Switchgear and instrument cluster panel lighting, front and rear map lights, front footwell lights, trunk illumination and front and rear downlighters	●	●	●	●	●	●
Driver and front passenger sunvisors with illuminated vanity mirrors	●	●	●	●	●	●
Blue halo illumination on front and rear door signature lines and front and rear door release	—	—	●	—	●	●
Glove box illumination	—	—	●	●	●	●
10 color selectable variable illumination including door storage, console and instrument panel plus rear footwells illumination and front and rear puddle lights	—	—	—	●	P4	P4
MIRRORS & WINDOWS						
Auto-dimming interior rear view mirror	●	●	●	●	●	●
Front and rear electric windows with one-touch open/close and anti-trap	●	●	●	●	●	●
Acoustic layer windshield	●	●	●	●	●	●
Infrared reflective front windshield glass	●	●	●	●	●	●
Heated rear window	●	●	●	●	●	●
Heated front windshield with timer. Includes heated windshield jets	P1	○	○	○	○	○

WINDOW SUNBLINDS

	XF	PREMIUM	PRESTIGE	PORTFOLIO	R-SPORT	S
Electric rear window sunblind (not available on XF Sportbrake)	—	—	—	●	P4	P4
Manual rear side window blinds	—	—	—	●	P4	P4

SEATING

10x10 way front seats with 8x8 electric movement - Fore/Aft (2), Cushion Height (2) & Tilt (2), Squab Recline (2) - plus manual Headrest Height (2)	●	●	●	—	●	—
14x14 way front seats with 12x12 electric movements - Fore/Aft (2), Cushion Height (2), Cushion Tilt (2) & Extension (2), Squab Recline (2), Bolster (2) plus manual Headrest Height (2)	—	—	—	—	—	●
16x16 way front seats with 14x14 electric movements - Fore/Aft (2), Cushion Height (2), Cushion Tilt (2) & Extension (2), Squab Recline (2), Bolster (2), headrests height (2) plus manual winged headrest	—	—	—	●	—	—
Front seats 4-way power lumbar	—	—	●	●	●	●
Sport-style front seats	—	—	—	—	●	●
3-stage heated front seats	P1	P1	●	●	●	●
3-stage active ventilated heated and cooled front seats	—	—	P3	●	P3	P3
3-stage heated rear seats	P1	P1	P3	●	P3	P3
Memory function with 3 settings for driver seat, exterior mirrors and steering wheel column	●	●	●	●	●	●
Front passenger seat memory	—	—	—	●	—	●
Rear folding seat (40/20/40 split)	—	●	●	●	●	●
Rear armrest with twin cupholders	●	●	●	●	●	●
Three rear headrests	●	●	●	●	●	●

STEERING WHEEL & CONTROLS

Soft grain leather steering wheel with Jaguar Sequential Shift™ paddles and remote controls for audio, cruise control, Bluetooth* wireless technology and JaguarVoice™	●	●	—	—	—	—
Soft grain leather sport steering wheel with Jaguar Sequential Shift™ paddles and remote controls for audio, cruise control, Bluetooth* wireless technology and JaguarVoice™	—	—	●	●	●	●
Heated steering wheel	P1	P1	●	●	●	●
'R-Sport' script on steering wheel	—	—	—	—	●	—
'S' script on steering wheel	—	—	—	—	—	●
Power adjustable steering column (reach and rake)	—	●	●	●	●	●
Three flash lane change/turn indicator	●	●	●	●	●	●

2 CHOOSE YOUR OPTIONS

 Configure your vehicle at jaguarusa.com

INTERIOR FEATURES CONTINUED

	XF	PREMIUM	PRESTIGE	PORTFOLIO	R-SPORT	S
INTERIOR TRIM						
Front center console with storage compartment**, twin cupholders, auxiliary power socket and armrest	●	●	●	●	●	●
Luxtec seat trim	●	●	—	—	—	—
Perforated grained leather seat trim	—	—	●	—	—	—
Perforated grained leather seat trim with contrast stitch	—	—	—	●	—	●
Perforated Windsor leather seat trim	—	—	—	—	●	—
Luxtec-wrapped instrument panel	●	●	●	—	●	●
Windsor leather wrapped instrument panel topper	—	—	—	●	—	—
'S' embossing on front seats	—	—	—	—	—	●
Seat back map pocket - Net	—	—	●	●	●	●
INSTRUMENT PANEL FINISHERS						
Morse Code Aluminum	●	●	●	●	—	—
Dark Morse Code Aluminum	—	—	—	—	●	—
Dark Hex Aluminum	—	—	—	—	—	●
VENEER TRIM						
Gloss Black finish	●	●	●	—	●	—
Grey Figured Ebony	—	—	—	—	—	●
Gloss Burl Walnut†	—	—	○	○ ⁺	○	—
Gloss Figured Ebony	—	—	—	●	—	○
Satin Burl Ash†	—	—	—	○ ⁺	○	—
Satin Fine Line	—	—	—	—	—	○
Carbon Fiber veneer†	—	—	—	○ ⁺	○	○
Morzine headliner	●	●	●	—	●	●
Suedecloth premium headliner	—	—	—	●	P4	P4
Ebony headliner	—	—	—	●	—	●
Light Oyster headliner	●	●	●	—	●	—

INFORMATION, COMMUNICATION AND ENTERTAINMENT

	XF	PREMIUM	PRESTIGE	PORTFOLIO	R-SPORT	S
MULTIMEDIA						
Physical dials with 5" full color TFT-LCD display	●	●	●	—	●	●
Full 12.3" TFT / LCD instrument cluster	—	P6	P6	●	P6	P6
Touch - 8" capacitive Touchscreen display with controls for audio, climate control, Bluetooth* and navigation (when fitted)* ¹	●	●	●	—	●	●
Touch Pro - 10" capacitive Touchscreen display with controls for audio, climate control, Bluetooth* and navigation* ¹	—	P6	P6	●	P6	P6
ECO HMI - Includes Eco data analysis, Parasitic load monitor and Driver Eco rating	●	●	●	●	●	●
Meridian 380W Sound System with 11 speakers including 1 subwoofer	●	●	●	—	●	●
Meridian 825W 7.1 Channel Digital Surround Sound System plus Meridian Trifold Mode, 17 speakers including 1 subwoofer, separate DSP, Audyssey MultEQ and Meridian Cabin Correction	—	—	P6	●	P6	P6
Dynamic Volume Control	●	●	●	●	●	●
HD Radio™	●	●	●	●	●	●
Front media interface (USB & iPod*)	●	●	●	●	●	●
SiriusXM® Satellite Radio* ⁴ (includes 3 mo. complimentary subscription)	○	○	○	●	●	●
InControl Apps™ enables use of optimized 3 rd party smartphone apps installed on a phone through the vehicle Touchscreen* ¹	○ w/Nav	○ w/Nav	●	●	●	●
NAVIGATION						
Navigation system with SD Card-based mapping* ²	○	○	●	—	●	●
Touch Pro - Navigation system with 60GB Solid-State Drive (SSD) based mapping. Includes HDD-based "virtual multichanger" and single slot in dash CD/DVD player* ¹	—	—	P6	●	P6	P6
Bluetooth® wireless technology for cell phone and audio streaming* ²	●	●	●	●	●	●
TELEMATICS						
Protect - SOS Emergency Call, Jaguar Assistance Call and Stolen Vehicle Locator. Service complimentary for 5 years	●	●	●	●	●	●
Remote - Smartphone application for vehicle status (fuel level, security status, last parked, direction to vehicle), vehicle lock/unlock, A/C remote setting through engine start. Feature complimentary for 5 years	●	●	●	●	●	●
Wi-Fi Hotspot - 4G Hotspot - includes 3GB or 3 months (which ever comes first) complimentary data subscription* ³	○	○	○/P6	●	○/P6	○/P6

● Standard ○ Option — Not available NCO No cost option

P1 Cold Climate Package P2 Vision Package P3 Comfort & Convenience Package P4 Luxury Interior Upgrade Package P5 Driver Assistance Package P6 Technology Package P7 Black Package

*Please see page 103 for further information.

**Not available with Four-zone Climate Control.

†Limited availability.

OPTION PACKAGES

		XF	PREMIUM	PRESTIGE	PORTFOLIO	R-SPORT	S	
	CODE							DESCRIPTION
Cold Climate Package (P1)	Z88D	○	○	—	—	—	—	Heated front seats, heated rear seats, heated steering wheel, heated front windshield with heated washer jets
Vision Package* ⁵ (P2)	Z86A	—	○	○	—	—	—	LED headlights with signature Daytime Running Lights, Adaptive Front Lighting with Auto High Beam Assist (AHBA), Front and Rear Parking Aid (standard on the Prestige model, included in the Package for the Premium model), Emergency Braking, Lane Departure Warning, Blind Spot Monitor with Closing Vehicle Sensing and Reverse Traffic Detection
Comfort & Convenience Package (P3)	Z28C	—	—	○	●	○	○	Cooled front seats, heated rear seats, Soft Door Close, Power open/close Gesture Tailgate
Luxury Interior Upgrade Package (P4)	Z61V	—	—	—	●	○	○	Electric rear sunblind (not available on XF Sportbrake), Manual rear side window blinds, Four-zone Climate Control (inc B-pillar vents and ducts in glove box), Suedecloth premium headliner, ambient lighting upgrade including 10 color variable illumination, Illuminated metal sill finishers with Jaguar script
Driver Assistance Package* ⁵ (P5)	Z68X	—	—	—	—	○	○	Adaptive Cruise Control (ACC) with Forward Alert, Advanced Emergency Brake Assist with Queue Assist and Intelligent Emergency Braking, 360° Parking Aid, Traffic Sign Recognition and Intelligent Speed Limiter, Blind Spot Assist, Park Assist - Parallel, Perpendicular & Parallel Exit
Technology Package* ¹ (P6)	Z80U	—	○	○	●	○	○	Touch Pro - SSD-based Navigation with single slot in dash CD/DVD player, 10" capacitive Touchscreen, full 12.3" TFT/LCD virtual instrument cluster Pro Services and Wi-Fi Hotspot, Meridian 825W Surround Sound System
Black Package (P7)	Z93L	—	—	—	—	—	○	Radiator grille - Gloss Black insert with Gloss Black surround, Gloss Black side power vents, Gloss Black trunk finisher

STAND ALONE OPTIONS

Heated front windshield	D96A	P1	○	○	○	○	○	—
Head-up Display	G62A	—	—	○	●	○	○	—
Navigation with SD Card-based mapping plus Jaguar InControl Apps	G61C	○	○	●	—	●	●	—
Head-up Display* ⁵	G62A	—	—	○	●	○	○	Refer to page 38
SiriusXM* Satellite Radio* ⁴ (includes 3 month complimentary service)	B51D	○	○	○	●	●	●	—
4G Wi-Fi Hotspot* ³ with 3GB or 3 month complimentary data plan (which ever comes first)	A44A	—	○	○	●	○	○	Refer to page 43
Adaptive Dynamics with Configurable Dynamics* ⁵	C35A	—	—	○	○	○	●	Refer to page 29
Powertrain '20d' '25t' or '30t' debadging	B05H	—	NCO	NCO	—	NCO	—	—
Rear View Camera* ⁵	C14A	○	●	●	●	●	●	—
Keyless Entry	F04B	—	○	●	●	●	●	—
Cargo space Partition Net (only available on XF Sportbrake)	C02B	—	—	—	—	—	○	—
Cargo space Storage Rails (only available on XF Sportbrake)	H52C	—	—	—	—	—	○	—
Cabin Air Ionization (only available on XF Sportbrake)	J59B	—	—	—	—	—	○	—
Activity Key (only available on XF Sportbrake)	F05D	—	—	—	—	—	○	Refer to page 19

3 CHOOSE YOUR COLOR



Configure your vehicle at [JAGUARUSA.COM](https://www.jaguarusa.com)

The XF has limited color availability, please consult your local Jaguar Retailer for further details.

SOLID

Fuji White

Narvik Black

METALLIC

Yulong White

Santorini Black

Indus Silver

Corris Grey

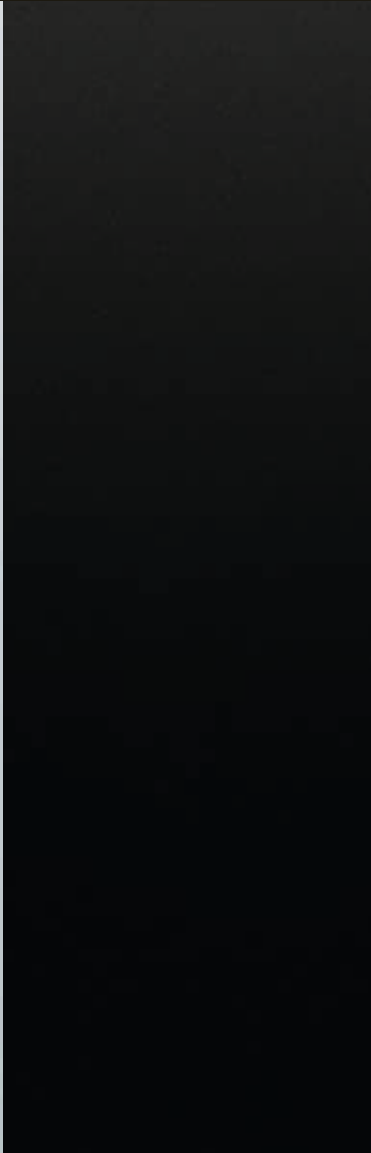
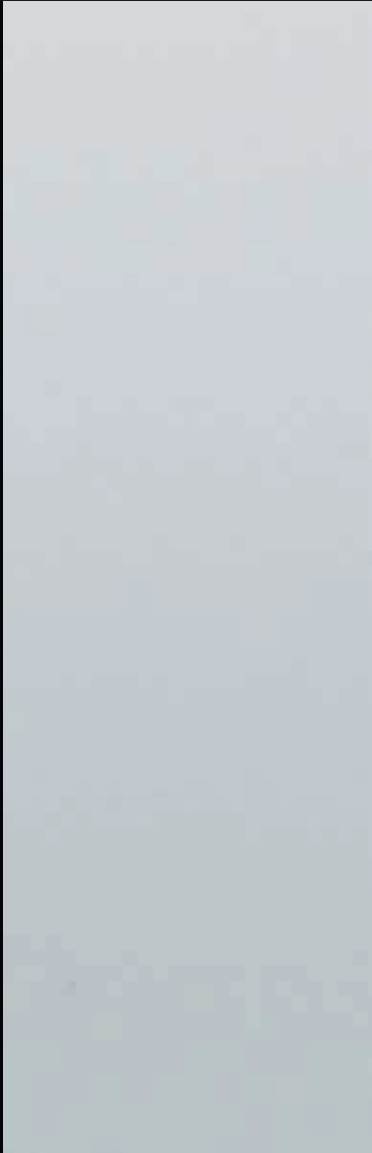

PREMIUM PALETTE

Loire Blue



Caesium Blue



Firenze Red



Rossello Red



Carpathian Grey

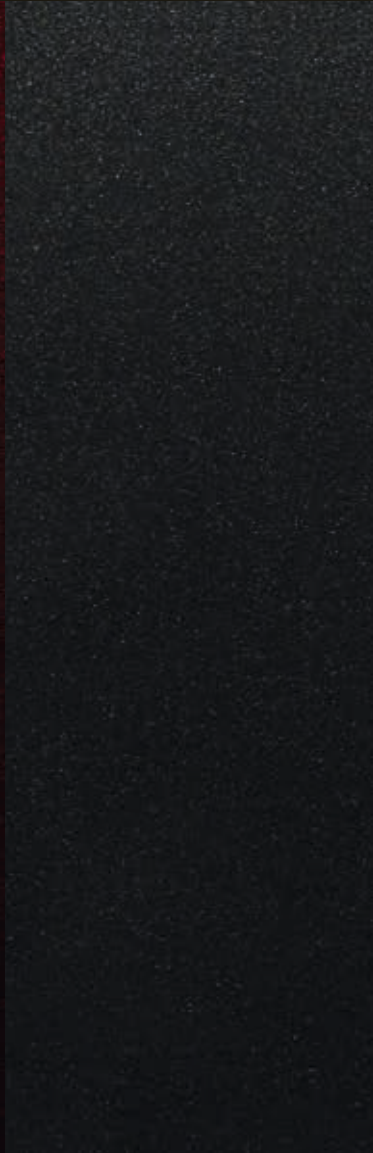

Silicon Silver

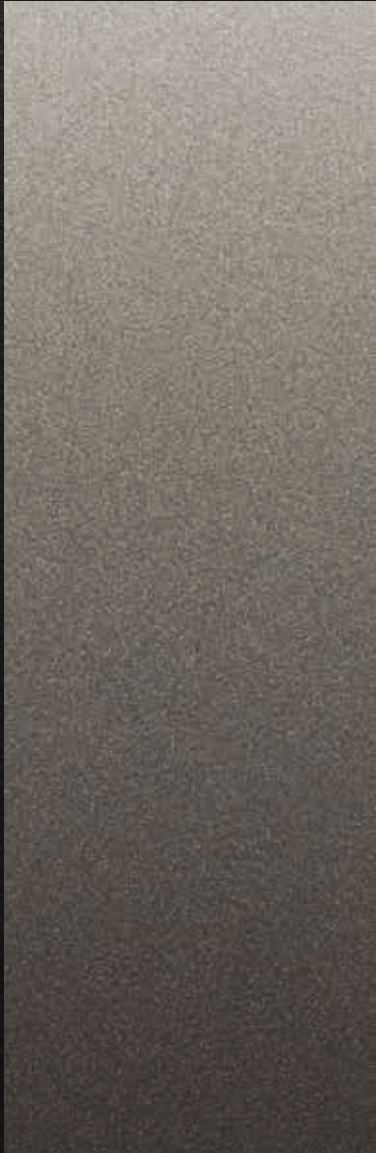

4 CHOOSE YOUR WHEELS

 Configure your vehicle at JAGUARUSA.COM



18" 5 SPOKE
'STYLE 5034'



18" 5 SPOKE
'STYLE 5033'



18" 7 SPLIT-SPOKE
'STYLE 7011'



19" 5 SPOKE
'STYLE 5035'

ALLOY WHEEL FINISH	Silver	Silver	Silver	Gloss Dark Grey/Diamond Turned
ALLOY WHEEL/SIZE	8.0 J x 18"	8.0J x 18"	8.0J x 18"	8.0J x 19"
TIRE SIZE	245/45 R18	245/45 R18	245/45 R18	245/40 R19
CODE	C53R	C53T	C53S	C53W
XF	● (20d & 25t)	—	—	—
Premium	—	● (20d & 25t)	● (35t only)	—
Prestige	—	—	—	—
Portfolio	—	—	—	—
R-Sport	—	—	—	● (20d & 25t)
S	—	—	—	—



19" 7 SPLIT-SPOKE
'STYLE 7012'



19" 10 SPOKE
'STYLE 1018'



19" 7 SPLIT-SPOKE
'STYLE 7013'



19" 7 SPLIT-SPOKE
'STYLE 7013'

ALLOY WHEEL FINISH	Silver	Silver	Silver	Contrast/Diamond Turned
ALLOY WHEEL/SIZE	8.0J x 19"	8.0J x 19"	8.0J x 19"	8.0J x 19"
TIRE SIZE	245/40 R19	245/40 R19	245/40 R19	245/40 R19
CODE	C53U	C53W	C53V	C53Z
XF	—	—	—	—
Premium	—	—	—	—
Prestige	● (35t only)	—	● (20d & 25t)	○
Portfolio	● (35t only)	—	—	—
R-Sport	—	● (35t only)	—	—
S	—	—	—	—

● Standard ○ Option — Not Applicable

Standard and optional features may differ depending on market availability.



20" 9 SPLIT-SPOKE
'STYLE 9004'



20" 9 SPLIT-SPOKE
'STYLE 9004'



20" 5 SPLIT-SPOKE
'STYLE 5071'

ALLOY WHEEL FINISH	Silver	Contrast/Diamond Turned	Silver
ALLOY WHEEL/SIZE	8.5J x 20"	8.5J x 20"	8.5J x 20"
TIRE SIZE	255/35 R20	255/35 R20	255/35 R20
CODE	C53H	C53J	C53K
XF	-	-	-
Premium	-	-	-
Prestige	○	-	-
Portfolio	-	-	-
R-Sport	-	○	○
S	-	-	-



20" 5 SPLIT-SPOKE
'STYLE 5031'



20" 5 SPLIT-SPOKE
'STYLE 5031'



20" 5 SPLIT-SPOKE
'STYLE 5036'

ALLOY WHEEL FINISH	Gloss Dark Grey/Diamond Turned	Gloss Black	Gloss Dark Grey/Diamond Turned
ALLOY WHEEL/SIZE	8.5J x 20"	8.5J x 20"	8.5J x 20"
TIRE SIZE	255/35 R20	255/35 R20	255/35 R20
CODE	C53F	C53L	C53G
XF	-	-	-
Premium	-	-	-
Prestige	-	-	-
Portfolio	-	-	-
R-Sport	-	-	-
S	●	○	○

5 CHOOSE YOUR INTERIOR

 Configure your vehicle at JAGUARUSA.COM

XF						
	SEAT WITH TONAL STITCH	VENEER	UPPER FASCIA WITH TONAL STITCH	HEADLINING MORZINE	CARPET	INTERIOR TRIM CODES
Luxtec seats	Ebony with Ebony	Gloss Black	Ebony with Ebony	Light Oyster	Ebony	TR23
	Latte with Latte	Gloss Black	Espresso with Espresso	Light Oyster	Espresso	TR24
	Light Oyster with Light Oyster	Gloss Black	Oyster with Oyster	Light Oyster	Oyster	TR25
PREMIUM						
	SEAT WITH TONAL STITCH	VENEER	UPPER FASCIA WITH TONAL STITCH	HEADLINING MORZINE	CARPET	INTERIOR TRIM CODES
Luxtec seats	Ebony with Ebony	Gloss Black	Ebony with Ebony	Light Oyster	Ebony	TR23
	Latte with Latte	Gloss Black	Espresso with Espresso	Light Oyster	Espresso	TR24
	Light Oyster with Light Oyster	Gloss Black	Oyster with Oyster	Light Oyster	Oyster	TR25
PRESTIGE						
	SEAT WITH TONAL STITCH	VENEER**	UPPER FASCIA WITH TONAL STITCH	HEADLINING MORZINE	CARPET	INTERIOR TRIM CODES
Grained leather seats	Ebony with Ebony	Gloss Black	Ebony with Ebony	Light Oyster	Ebony	TR26
	Latte with Latte	Gloss Black	Espresso with Espresso	Light Oyster	Espresso	TR27
	Light Oyster with Light Oyster	Gloss Black	Oyster with Oyster	Light Oyster	Oyster	TR28

**Optional veneers are available.

PORTFOLIO						
	SEAT WITH INSERT AND CONTRAST STITCH	VENEER**	UPPER FASCIA WITH CONTRAST STITCH	HEADLINING MORZINE	CARPET	INTERIOR TRIM CODES
Windsor leather seats	Sienna Tan with Sienna Tan	Gloss Figured Ebony	Ebony with Ebony	Ebony or Light Oyster	Ebony	TR41
R-SPORT						
	SEAT WITH INSERT AND CONTRAST STITCH	VENEER**	UPPER FASCIA WITH CONTRAST STITCH	HEADLINING MORZINE	CARPET	INTERIOR TRIM CODES
Grained leather sports seats	Ebony/Ebony with Light Oyster	Gloss Black	Ebony with Light Oyster	Ebony	Ebony	TR29
	Ebony/Pimento Red with Pimento Red	Gloss Black	Ebony with Pimento Red	Ebony	Ebony	TR30
	Ebony/Light Oyster with Light Oyster	Gloss Black	Ebony with Light Oyster	Ebony	Ebony	TR31
	Brogue/Brogue with Light Oyster	Gloss Black	Ebony with Light Oyster	Ebony	Ebony	TR32
S						
	SEAT WITH INSERT AND CONTRAST STITCH	VENEER**	UPPER FASCIA WITH CONTRAST STITCH	HEADLINING MORZINE	CARPET	INTERIOR TRIM CODES
Sports grained leather 'S' embossed seats	Ebony/Ebony with Light Oyster	Grey Figured Ebony	Ebony with Light Oyster	Ebony	Ebony	TR33 + B41T
	Pimento Red/Ebony with Ebony	Grey Figured Ebony	Ebony with Pimento Red	Ebony	Ebony	TR34 + B41T
	Light Oyster/Ebony with Ebony	Grey Figured Ebony	Ebony with Light Oyster	Ebony	Ebony	TR35
	Brogue/Brogue with Light Oyster	Grey Figured Ebony	Ebony with Light Oyster	Ebony	Ebony	TR36

5 CHOOSE YOUR INTERIOR

Configure your vehicle at [JAGUARUSA.COM](https://www.jaguarusa.com)

Interior shown: Ebony Luxtec seats with Ebony fascia, Morse Code Aluminum finisher, Gloss Black veneer and Light Oyster headlining.



XF AND XF PREMIUM

INTERIOR COLOR COMBINATIONS

1

SEAT WITH TONAL STITCH

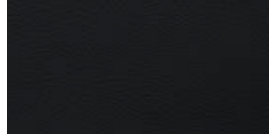

Ebony with Ebony

2

VENEER



Gloss Black

3

HEADLINING MORZINE



Light Oyster

4

UPPER FASCIA WITH TONAL STITCH



Ebony with Ebony

5

FINISHER



Morse Code Aluminum

6

CARPETS



Ebony

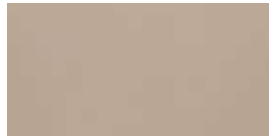

Latte with Latte



Gloss Black



Light Oyster



Espresso with Espresso

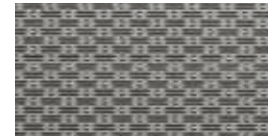

Morse Code Aluminum



Espresso



Light Oyster with Light Oyster



Gloss Black



Light Oyster



Oyster with Oyster



Morse Code Aluminum



Oyster

5 CHOOSE YOUR INTERIOR



















⚙️ Configure your vehicle at [JAGUARUSA.COM](https://www.jaguarusa.com)

Interior shown: Ebony grained leather seats with Ebony tonal stitch, Ebony fascia, Morse Code Aluminum finisher, Gloss Black veneer and Light Oyster headlining.



PRESTIGE

INTERIOR COLOR COMBINATIONS

1	2	3	4	5	6
SEAT WITH TONAL STITCH	VENEER	HEADLINING MORZINE	UPPER FASCIA WITH TONAL STITCH	FINISHER	CARPETS
					
Ebony with Ebony	Gloss Black	Light Oyster	Ebony with Ebony	Morse Code Aluminum	Ebony
					
Latte with Latte	Gloss Black	Light Oyster	Espresso with Espresso	Morse Code Aluminum	Espresso
					
Light Oyster with Light Oyster	Gloss Black	Light Oyster	Oyster with Oyster	Morse Code Aluminum	Oyster

VENEER OPTIONS

Gloss Burl Walnut Veneer

5 CHOOSE YOUR INTERIOR

⚙️ Configure your vehicle at [JAGUARUSA.COM](https://www.jaguarusa.com)

Interior shown: Sienna Tan Windsor leather with Sienna Tan tonal stitch, Ebony fascia, Morse Code Aluminum finisher, Gloss Figured Ebony veneer and Ebony suedecloth headliner.



PORTFOLIO

INTERIOR COLOR

STANDARD

1

SEAT WITH TONAL STITCH



Sienna Tan with Sienna Tan

2

VENEER



Gloss Figured Ebony

3

HEADLINING SUEDECLOTH



Ebony

4

UPPER FASCIA WITH TONAL STITCH

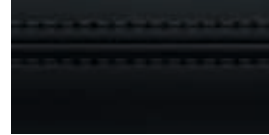

Ebony with Ebony

5

FINISHER



Morse Code Aluminum

6

CARPETS



Ebony

5 CHOOSE YOUR INTERIOR











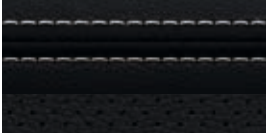

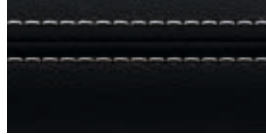

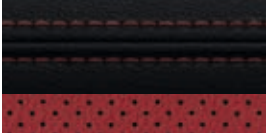

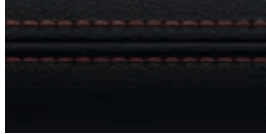

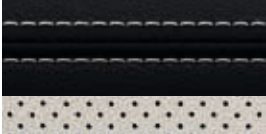
Configure your vehicle at JAGUARUSA.COM

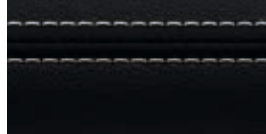
Interior shown: Ebony and Light Oyster perforated grained leather sports seats with Light Oyster contrast stitch, Ebony fascia with Light Oyster contrast stitch, Dark Morse Code Aluminum finisher, Gloss Black veneer and Ebony headlining.

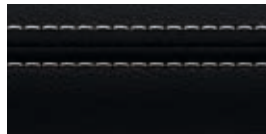

R-SPORT

INTERIOR COLOR COMBINATIONS

1	2	3	4	5	6
SEAT WITH INSERT AND CONTRAST STITCH	VENEER	HEADLINING MORZINE*	UPPER FASCIA WITH CONTRAST STITCH	FINISHER	CARPETS
					
Ebony/Ebony with Light Oyster	Gloss Black	Ebony	Ebony with Light Oyster	Dark Morse Code Aluminum	Ebony
					
Ebony/Pimento Red with Pimento Red	Gloss Black	Ebony	Ebony with Pimento Red	Dark Morse Code Aluminum	Ebony
					
Ebony/Light Oyster with Light Oyster	Gloss Black	Ebony	Ebony with Light Oyster	Dark Morse Code Aluminum	Ebony
					
Brogue/Brogue with Light Oyster	Gloss Black	Ebony	Ebony with Light Oyster	Dark Morse Code Aluminum	Ebony

VENEER OPTIONS

Carbon Fiber Veneer, Satin Burl Ash Veneer or Gloss Burl Walnut Veneer

*Morzine headlining replaced by suedecloth headlining when Luxury Interior Upgrade Package selected.

5 CHOOSE YOUR INTERIOR













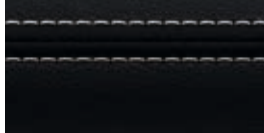







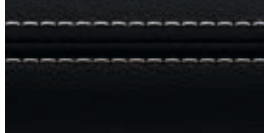

Configure your vehicle at JAGUARUSA.COM

Interior shown: Light Oyster and Ebony perforated grained leather sports seats with Ebony contrast stitch, Ebony fascia with Light Oyster contrast stitch, Dark Hex Aluminum finisher, Grey Figured Ebony veneer and Ebony headlining.

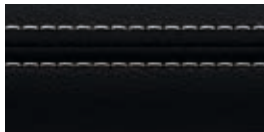

S

INTERIOR COLOR COMBINATIONS

1	2	3	4	5	6
SEAT WITH INSERT AND CONTRAST STITCH	VENEER	HEADLINING MORZINE*	UPPER FASCIA WITH CONTRAST STITCH	FINISHER	CARPETS
 Ebony/Ebony with Light Oyster	 Grey Figured Ebony	 Ebony	 Ebony with Light Oyster	 Dark Hex Aluminum	 Ebony
 Pimento Red/Ebony with Ebony	 Grey Figured Ebony	 Ebony	 Ebony with Pimento Red	 Dark Hex Aluminum	 Ebony
 Light Oyster/Ebony with Ebony	 Grey Figured Ebony	 Ebony	 Ebony with Light Oyster	 Dark Hex Aluminum	 Ebony
 Brogue/Brogue with Light Oyster	 Grey Figured Ebony	 Ebony	 Ebony with Light Oyster	 Dark Hex Aluminum	 Ebony

VENEER OPTIONS

Gloss Figured Ebony Veneer, Carbon Fiber Veneer or Satin Fine Line Veneer

*Morzine headlining replaced by suedecloth headlining when Luxury Interior Upgrade Package selected.

5 CHOOSE YOUR INTERIOR

 Configure your vehicle at [JAGUARUSA.COM](https://www.jaguarusa.com)

Gloss Black Veneer

Carbon Fiber Veneer

Satin Burl Ash Veneer

Gloss Figured Ebony Veneer



Grey Figured Ebony Veneer



Satin Fine Line Veneer



Gloss Burl Walnut Veneer

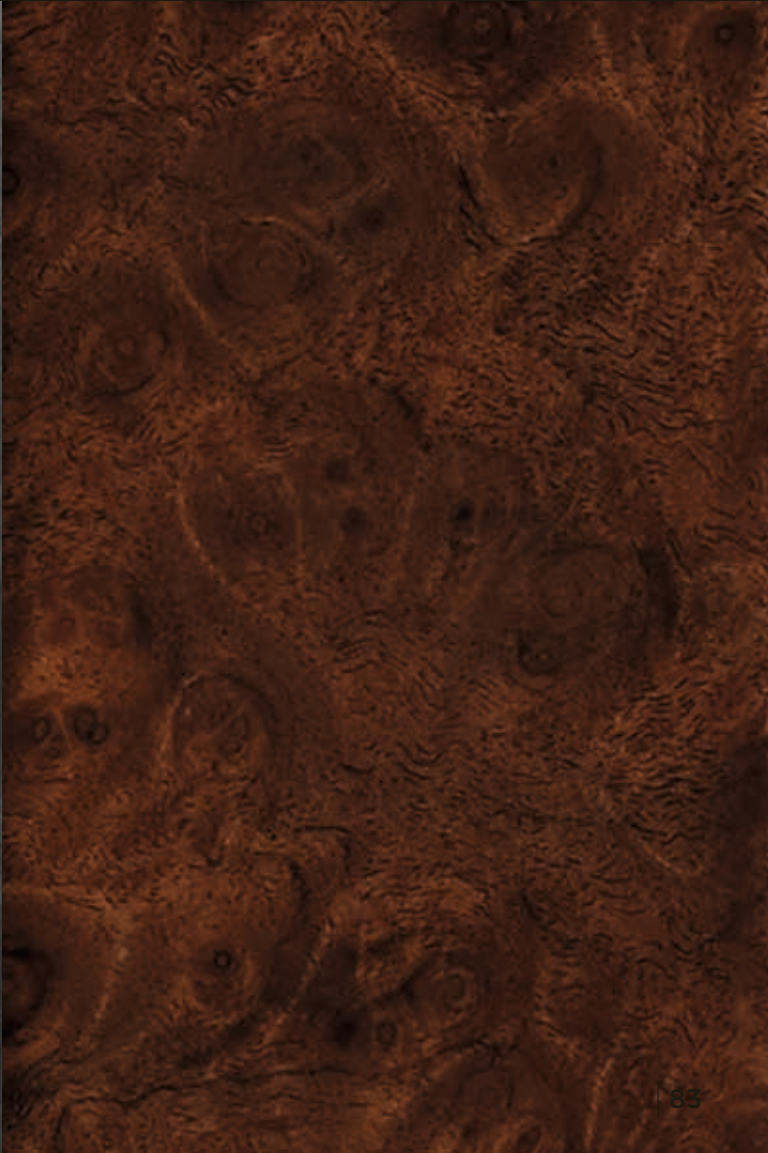

6 CHOOSE YOUR JAGUAR GEAR

The genuine range of accessories from Jaguar.

 Configure your vehicle at [JAGUARUSA.COM](https://www.jaguarusa.com)



Watersports Carrier**
C2Z21730

A versatile system for transporting a variety of water sports equipment including surfboard, kayak or sailboard. Tilts to facilitate loading/unloading.

**Requires roof cross bars T2H14468.

VEHICLE SHOWN: XF SEDAN S IN YULONG WHITE WITH OPTIONAL EQUIPMENT



Aluminum Paddle Shifters
T2R6547MMU (Brushed Aluminum - shown)
T2R6547CAY (Red)

Replacement steering wheel gearshift paddles offered in a premium aluminum material providing a high quality finish to a key contact point in the vehicle. Manufactured from billet machined aluminum, the paddles are hand brushed for a premium finish and anodized to ensure they will not deteriorate with wear.



Luxury Carpet Mat Set
T2H7171PVJ (Jet - shown)
T2H7171AMT (Oyster)
T2H7171AAM (Espresso)
T2H7173PVJ (Jet, AWD only)
T2H7173AMT (Oyster, AWD only)
T2H7173AAM (Espresso, AWD only)

Luxurious, tailored 60.46oz / yd² carpet mat set with Jaguar Ingot and Nubuck edge binding.



Central Armrest Chiller/Warmer
T2H7739

Food and drinks chiller and warmer that acts as a rear center armrest. With a leather-covered top, it is held in place by the center seat belt and powered from the rear auxiliary socket. Ideal for long trips with the family.



iPad® Holder
T2H7757 Fits iPad® 1, 2, 3 & 4 (not mini)
T2H7758 - Fits iPad Mini™

Jaguar branded iPad® holder mounts to front seat headrests providing a flexible solution for rear seat entertainment. Quick release design ensures iPad® can be fitted or removed quickly and easily.

*Not available for XF.



Personalized Illuminated Sill Treadplates†
T2H17122PVJ

Elegantly styled stainless steel sill treadplate finishers for driver or passenger doors. Illuminates when either the driver or passenger doors are opened. Highlighted by soft Phosphor Blue lighting. Allows customer to specify a monochrome 'motif' in a choice of approved typefaces/scripts.



Rear Splash Guards
T2H12954

Jaguar branded, rear splash guards complement the lines of your vehicle and provide protection from dirt and stone chippings.

6 CHOOSE YOUR JAGUAR GEAR

⚙️ Configure your vehicle at JAGUARUSA.COM



Gloss Black Side Vent**
T4N5176 - Left Side
T4N5178 - Right Side

Jaguar branded, Gloss Black side power vents provide a dynamic exterior styling enhancement.



Carbon Fiber Side Vent
T2H18318 - Left Side
T2H18319 - Right Side

High grade Carbon Fiber side power vents provide a performance-inspired styling upgrade.



All-Weather Car Cover†
T2H7756

All-weather tailored cover for the XF with the Jaguar logo. Protect your XF from the elements, including showers, frost and dust. Quick and easy to fit.



Gloss Black Mirror Cap
C2D6067PEC - Left Side
C2D6066PEC - Right Side

Gloss Black mirror covers accentuate the dynamic design of the exterior mirrors.



Carbon Fiber Mirror Cap
C2P24176 - Right Side
C2P24177 - Left Side

High grade Carbon Fiber mirror covers provide a performance-inspired styling upgrade.



Rear Tailgate Trim - Gloss Black†
T2H6925

Add style and visual distinction with Gloss Black finish rear tailgate trim.

**Not applicable for R-Sport. †Not available on Sportbrake. **Requires roof cross bars T2H14468.



Roof Cross Bars
T2H14468

Jaguar branded cross bars required for fitting all roof carrying equipment. Engineered specifically for your vehicle.



Roof Sport Box**
C2C41627

Spacious 11 cubic feet capacity lockable roof box designed for sports equipment, measuring 81 x 33 x 13 inches.



Roof Mounted Cycle Carrier**
C2A1540

An easy to fit, roof mounted, lockable cycle carrier which carries one bike per holder. A maximum of three holders can be fitted.



Premium Cargo space Carpet Mat†
T2H7174PVJ - Space Saver NLI Variant
T2H7175PVJ - Space Saver NGL Variant
T2H7176PVJ - Non Space Saver Variant

Luxurious soft luggage mat in Jet Black with the Jaguar logo. Deep premium 60.46 oz/yd2 pile with Nubuck edging and Dove contrast stitch. For vehicles equipped with InControl Touch Pro™ and fitted with space saver spare wheel OR for vehicles fitted with tire repair kit.



Rear Spoiler†
T2H6236LML

Give the XF an even more sporting look with this body-colored spoiler exterior styling upgrade. For XF, Premium, Prestige and Portfolio rear luggage compartment lid spoiler in primed condition for painting. Spoiler is standard for R-Sport and 'S'.

6 CHOOSE YOUR JAGUAR GEAR

 Configure your vehicle at JAGUARUSA.COM



Roof Mounted Cycle Carrier* C2A1539

An easy to fit, roof mounted, lockable cycle carrier which carries one bike per holder. A maximum of three holders can be fitted.

*Requires Roof Cross Bars T2H24300. **Only available on XF Sportbrake.

VEHICLE SHOWN: XF SPORTBRAKE S IN YULONG WHITE WITH OPTIONAL EQUIPMENT



Roof Cross Bars
T2H24300**

Jaguar branded cross bars required for fitting all roof carrying equipment. Engineered specifically for your vehicle.



**Roof Sport Box†
C2C41627**

Spacious 11.3 cu.ft. capacity lockable roof box designed for sports equipment, measuring 81.1 x 33 x 13.3 inches.



**Fork Mounted Cycle Carrier†
C2A1540**

Fitted to the roof, the fork mounted cycle carrier provides a simple and secure fitting with the bike front wheel removed, ideally suited to lightweight bikes and 'racing' wheels. A separate carrier is included for the front wheel. Easy to fit, lockable cycle carrier which carries one bike per holder. A maximum of three holders can be fitted.



**Watersports Carrier†
C2Z21730**

A versatile system for transporting a variety of water sports equipment including surfboard, kayak or sailboard. Tilts to facilitate loading/unloading.



**Ski/Snowboard Holder†
C2A1538**

A safe and secure Jaguar branded system for transporting winter sports equipment. Incorporates slider rails for easy loading. For four pairs of skis or two snowboards.

6 CHOOSE YOUR JAGUAR GEAR

 Configure your vehicle at jaguarusa.com



Click and Play - iPad® 2-4**
J9C2163

Click and Play is a removable tablet holder attachment which is available for various tablets, and can be easily positioned in multiple angles for in cabin comfort and rear entertainment.



Click and Hook**
J9C2169

Click and Hook is a universal hook that creates extra storage space for items to be hung.



Click and Hang**
J9C2167

Click and Hang is a removable coat hanger allowing for shirts and jackets to be kept crease-free while transporting.



Union Jack Sill Treadplates
T2H17123PVJ - Ebony
T2H17123AMT - Oyster

Elegantly styled stainless steel sill treadplate finisher for driver or passenger doors featuring a distinctly British design.



Sport Pedal Covers
T2H3746 - Automatic

Made from stainless steel and rubber, the pedal kit fits securely over existing pedals for a contemporary, sporting appearance. Standard on 'S'.



Luggage Compartment Waterproof Liner**
T2H24704

Total protection for the luggage compartment and second row seat back. Bespoke developed for XF Sportbrake, the liner is a fully waterproof and is easy to fit or remove in a matter of minutes.

**Only available on XF Sportbrake.



Aperture Retention Net**
T2H31242

The aperture retention net prevents small items from falling out of the cargo space when the tailgate is opened and maximizes packing space. Manufactured from premium lightweight materials including high grade machined aluminum to ensure robust quality.



Luggage Guard**
T2H31273

The luggage compartment partition is designed to prevent cargo from entering the passenger compartment.



Luggage Compartment Collapsible Organiser
T2H7752

Collapsible luggage compartment organizer keeps items from shifting during transport with two durable straps.



Luggage Compartment Rubber Mat**
T2H24552

This premium mat is tailored specifically to protect the luggage compartment. Light and durable, it is easily removable for cleaning.



Luggage Compartment Multi-purpose Liner**
T2H24651

All-in-one premium cargo space carpet mat and double layer reversible rubber liner helps protect the rear cargo space area from general dirt. The liner can be folded out to cover the back of the second row seats when folded down. Also includes fold out bumper protector.



Bumper Protector**
T2H24701

Provides protection for the rear bumper from scuffs and scratches and helps to prevent clothing from collecting dirt when loading and unloading.

TECHNICAL SPECIFICATIONS

 Configure your vehicle at JAGUARUSA.COM

ENGINES		20d 2.0 LITER 4 CYLINDER TURBOCHARGED DIESEL	25t 2.0 LITER 4 CYLINDER TURBOCHARGED GAS	30t 2.0 LITER 4 CYLINDER TURBOCHARGED GAS	S 3.0 LITER V6 380 SUPERCHARGED GAS
Drive		RWD	RWD	RWD	RWD
Capacity	cc	1,999	1,997	1,997	2,995
Maximum power	hp	180	247	296	380
@rev/min	rpm	4,000	5,500	5,500	6,500
Maximum torque	lb-ft	318	269	295	332
@rev/min	rpm	1,750 – 2,500	1,200 – 4,500	1,500 - 4,500	4,500
Transmission		8-speed Automatic	8-speed Automatic	8-speed Automatic	8-speed Automatic

PERFORMANCE*7		XF SEDAN	XF SEDAN	XF SEDAN	XF SEDAN
0-60 mph	seconds	8.0	6.3	5.6	5.1
Top speed	mph	121	121	121	121

DIMENSIONS		XF SEDAN	XF SEDAN	XF SEDAN	XF SEDAN
Overall length	in	195.0	195.0	195.0	195.0
Overall width (inc. mirrors)	in	82.3	82.3	82.3	82.3
Overall width (exc. mirrors)	in	78.2	78.2	78.2	78.2
Overall height	in	57.4	57.4	57.4	57.4
Wheelbase	in	116.5	116.5	116.5	116.5
Ground clearance	in	4.57	4.57	4.57	4.57
Turning circle diameter (curb-to-curb)	ft	38.1	38.1	38.1	38.1
Trunk volume	cu-ft	19.1	19.1	19.1	19.1
Tank capacity	US gallons	17.4	19.5	19.5	19.5

WEIGHT†		XF SEDAN	XF SEDAN	XF SEDAN	XF SEDAN
Curb weight from	lbs	3,520	3,604	3,665	3,770
Gross vehicle weight	lbs	4,960	5,070	4,982	5,137

ENGINE AVAILABILITY		XF SEDAN	XF SEDAN	XF SEDAN	XF SEDAN
XF		●	●	—	—
Premium		●	●	●	—
Prestige		●	●	●	—
Portfolio		—	—	●	—
R-Sport		●	●	●	—
S		—	—	—	●

● Available — Not Available

*Please see page 103 for further information.

†Weights reflect vehicles to standard specifications. Optional extras increase weight.

ENGINES		20d 2.0 LITER 4 CYLINDER TURBOCHARGED DIESEL	25t 2.0 LITER 4 CYLINDER TURBOCHARGED GAS	30T 2.0 LITER 4 CYLINDER TURBOCHARGED GAS	S 3.0 LITER V6 380 SUPERCHARGED GAS
Drive		AWD	AWD	AWD	AWD
Capacity	cc	1,999	1,997	1,997	2,995
Maximum power	hp	180	247	296	380
@rev/min	rpm	4,000	5,500	5,500	6,500
Maximum torque	lb-ft	318	269	295	332
@rev/min	rpm	1,750 - 2,500	1,200 - 4,500	1,500 - 4,500	4,500
Transmission		8-speed Automatic	8-speed Automatic	8-speed Automatic	8-speed Automatic

PERFORMANCE*7		XF SEDAN	XF SEDAN	XF SEDAN	XF SEDAN	XF SPORTBRAKE
0-60 mph	seconds	7.9	6.2	5.5	5.0	5.3
Top speed	mph	121	121	121	121	121

DIMENSIONS						
Overall length	in	195.0	195.0	195.0	195.0	195.0
Overall width (inc. mirrors)	in	82.3	82.3	82.3	82.3	82.3
Overall width (exc. mirrors)	in	78.2	78.2	78.2	78.2	78.2
Overall height	in	57.4	57.4	57.4	57.4	58.9
Wheelbase	in	116.5	116.5	116.5	116.5	116.5
Ground clearance	in	4.57	4.57	4.57	4.57	4.57
Turning circle diameter (curb-to-curb)	ft	38.1	38.1	38.1	38.1	38.1
Trunk volume	cu-ft	19.1	19.1	19.1	19.1	19.9
Tank capacity	US gallons	17.4	19.5	19.5	19.5	19.8

WEIGHT†						
Curb weight from	lbs	3,750	3,715	3,785	3,880	4,045
Gross vehicle weight	lbs	5,093	5,202	5,140	5,225	5,357

ENGINE AVAILABILITY						
XF		●	●	—	—	—
Premium		●	●	●	—	—
Prestige		●	●	●	—	—
Portfolio		—	—	●	—	—
R-Sport		●	●	●	—	—
S		—	—	—	●	●

XF SEDAN DIMENSIONS

Overall Width (inc mirrors) 82.3 inches

Overall Width (exc mirrors) 74.0 inches

Trunk Volume 17.8 cu ft (with space saver)



VEHICLE SHOWN: XF SEDAN S IN YULONG WHITE WITH OPTIONAL EQUIPMENT

Turning Circle
Curb-to-Curb 38.1 ft

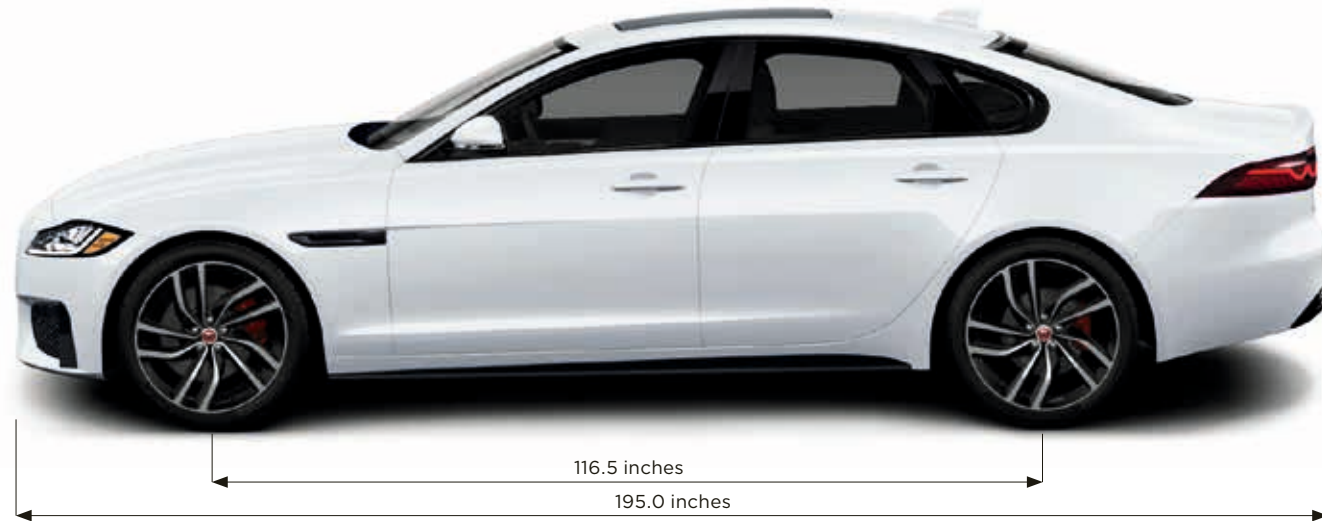

Dimensions were measured with vehicle at unladen weight.
(measured by VDA standard test method using 200 x 100 x 50mm blocks).

XF SPORTBRAKE DIMENSIONS

Overall Width (inc mirrors) 82.3 inches

Overall Width (mirrors folded) 78.2 inches

Trunk Volume 19.7 cu.ft.**

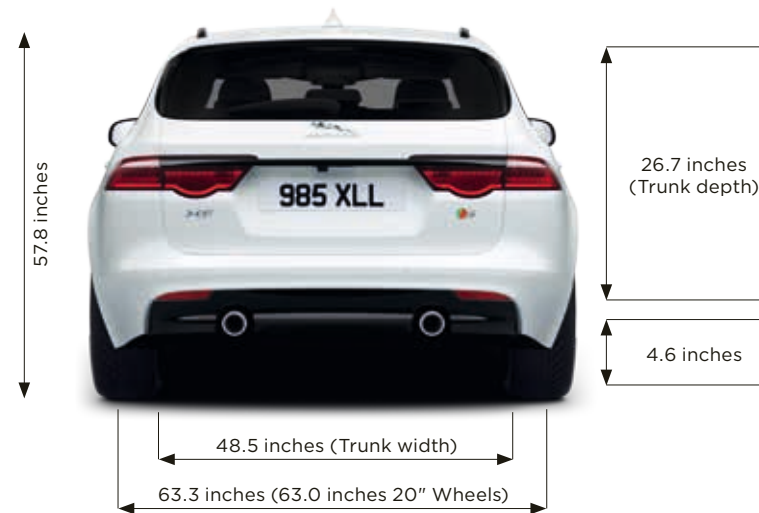

VEHICLE SHOWN: XF SPORTBRAKE S IN YULONG WHITE WITH OPTIONAL EQUIPMENT

Turning Circle
Curb-to-Curb 38 ft.

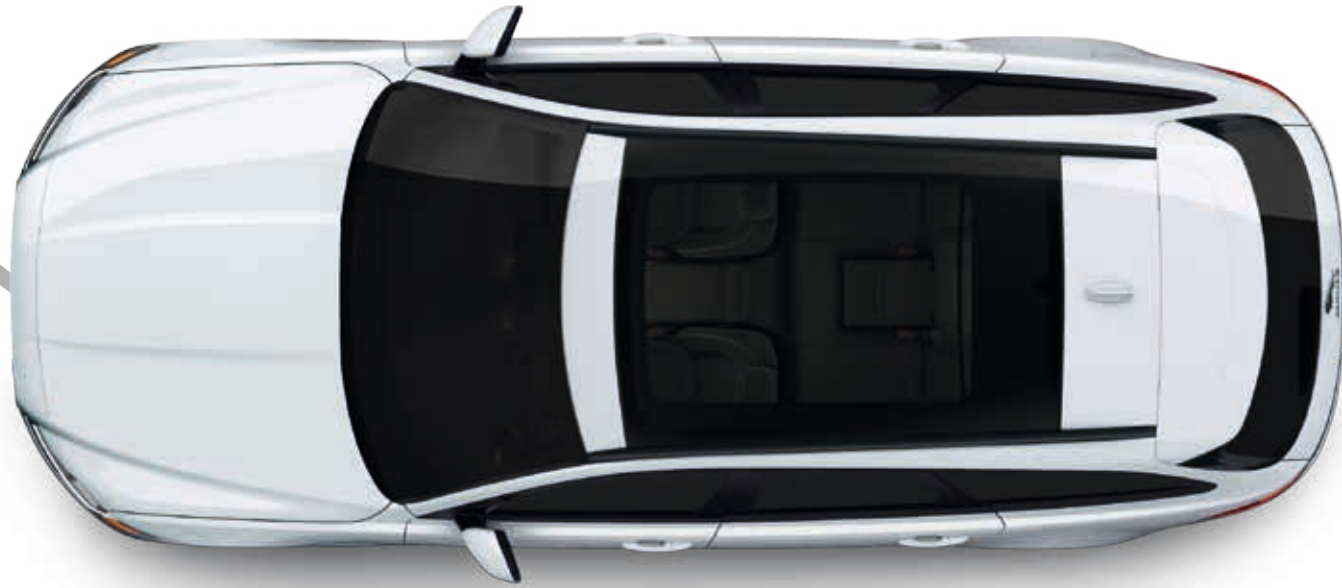

45 inches
(Trunk length)



116.5 inches
195.1 inches

**4.6 inches for 30d 3.0 liter V6 Twin Turbocharged Diesel.
Dimensions were measured with vehicle at unladen weight.
(measured by VDA standard test method using 200 x 100 x 50mm blocks).

JAGUAR EXPERIENCE

There's no better way to get to know Jaguar than by taking a drive. The Jaguar Experience offers a range of unique opportunities to really find out what it feels like to get the most out of a Jaguar. Our track experiences allow you to push yourself and vehicles from the incredible Jaguar range to the limit. Jaguar Experience also offers the opportunity to see a Jaguar vehicle brought to life during a tour of one of our UK manufacturing facilities.

Find out more by visiting JAGUARUSA.COM



BEHIND THE SCENES

Our factory tours give you the unique opportunity to experience the whole process of how our vehicles are brought to life – from the molding of sheet metal to those intricate final touches. At our state-of-the-art production facilities, you'll get to see how skilled technicians and sophisticated machines work seamlessly together to perfect some of Jaguar's most breathtaking cars – from the powerful F-TYPE to the groundbreaking F-PACE performance SUV.

Find out more at JAGUARUSA.COM



DRIVING EXPERIENCES

The opportunity to drive the latest Jaguar vehicles at their limits, or relive iconic Jaguar history, is rare. Jaguar Driving Experiences offer unique driving adventures you will never forget. Imagine yourself behind the wheel of our highest performing Jaguar models, on a closed course, with a Jaguar Experience Instructor at your side.

Find out more at JAGUARUSA.COM

European model shown.



ICONIC EXPERIENCES

Take your driving to the next level with our international adventures facing extreme road conditions. Our Iconic Experiences offer journeys and challenges that will test and develop your performance driving skills. Every year, Jaguar customers and enthusiasts join us for our luxury Ice Driving Experience. The exclusive ski resort in Gstaad, Switzerland, is the perfect location to enjoy the thrill of performance driving on ice. Our Ice Driving Experience is a two-day getaway held each winter. You can get a flavor of the event below. Then, if you'd like to be part of it in the next experience, we can keep you posted.

Find out more by visiting JAGUARUSA.COM

THE WORLD OF JAGUAR

Choose an XF and you're joining the exciting World of Jaguar. It makes owning and driving carefree and easy, as well as providing a range of exclusive services and lifestyle products.

JAGUAR ELITECARE

Enjoy your Jaguar with peace of mind. The XF is backed by Jaguar EliteCare, our exceptional 5 year / 60,000 mile coverage*⁹ program including New Vehicle Limited Warranty, Complimentary Scheduled Maintenance, Roadside Assistance and Jaguar InControl Remote & Protect™.



NEW VEHICLE LIMITED WARRANTY

The New Vehicle Limited Warranty (the 'Warranty') lets you enjoy your driving with peace of mind and runs for a best in class 5 years or 60,000 miles, whichever occurs first. The Warranty is fully transferable to subsequent owners and remains in effect throughout the Warranty coverage period.

*Please see page 103 for further information.



COMPLIMENTARY SCHEDULED MAINTENANCE**

Relax in the knowledge that long-term performance is assured with the Complimentary Scheduled Maintenance Coverage. It covers factory recommended scheduled servicing as detailed in the 'Passport to Service' for 5 years or 60,000 miles, whichever occurs first. A Service Interval Indicator will appear every 16,000 miles or every 12 months, to remind you to take advantage of your complimentary maintenance.

GENUINE PARTS

Jaguar Genuine Parts are designed, tested and manufactured to our uncompromising standards for quality, fit and durability. Each part is engineered specifically for the XF to contribute to optimum performance and to help maximize its lifespan.



ROADSIDE ASSISTANCE

Jaguar Roadside Assistance provides help in motoring emergencies, from immobilization due to breakdown or accident to minor problems such as punctures. You can rely on our roadside assistance, whatever the situation, anywhere in North America during the vehicles warranty period.



THE JAGUAR MAGAZINE

This is our own vibrant, cosmopolitan and contemporary magazine. Produced by a team of enthusiastic designers and feature writers, it goes behind the scenes at Jaguar as well as providing insight into the world of luxury, design, style and travel.

JAGUAR COLLECTION

The latest range from the Jaguar Collection has been crafted with the same design execution and attention to detail that goes into all of our vehicles. This is evident in our clothing range, premium leather items and luxury travel goods. To celebrate Jaguar's heritage we also have a collection that honors past achievements and features race-inspired gift items and apparel. Visit shop.jaguarusa.com to browse the Jaguar Collection.

GLOSSARY

A

ADAPTIVE FULL LED HEADLIGHTS

Adaptive headlights automatically adjust to follow steering inputs, casting light where needed. They will angle the beam when indicating, as well as working in conjunction with Auto High Beam Assist (AHBA) if fitted to the vehicle to prevent your lights from dazzling oncoming traffic.

ADAPTIVE SPEED LIMITER

The Adaptive Speed Limiter, when selected, will assist in limiting vehicle speed to the speed limits as recognized by the Traffic Sign Recognition system.

AUX CONNECTION

Auxiliary (AUX) connections allow for the convenient input of audio signals from personal devices into the vehicle multimedia system.

C

Cd

The Cd value is the coefficient drag of the car. It gives an indication of the vehicle aerodynamic qualities. The lower the value, the more aerodynamically efficient the vehicle design.

CONFIGURABLE INTERIOR MOOD LIGHTING

Configurable Interior Mood Lighting highlights a number of key functional and styling features of your Jaguar and allows adjustment of the ambient light. Choose from a range of 10 colors.

D

DAMPERS/DAMPING

Dampers absorb forces acting on the suspension for greater ride comfort and control. Dampers are also known as shock absorbers.

DEAD RECKONING

Dead Reckoning uses sensors to measure vehicle direction, wheel rotation and inclination. These measurements are calibrated up to 40 times per second to ensure accurate placement of the vehicle even when no GPS signal is available.

E

ECO MODE

Eco Mode encourages fuel efficient driving by reducing throttle sensitivity, selecting more economical engine mapping. It also reduces fuel consumption by reducing the energy demands placed on the engine by climate control and audio systems.

F

FORWARD ALERT

Should a potential collision be detected Forward Alert gives an audible warning and a visual warning in the instrument cluster.

FOUR-ZONE CLIMATE CONTROL

Automatic Four-zone climate control that allows rear occupants to optimize cabin temperature and air flow for their individual position.

G

GPS

The Global Positioning System (GPS) uses satellites to determine the car position. By cross-referencing this with road maps stored in the vehicle memory, the navigation system provides route guidance and tracks the car location.

I

INTERIOR MOOD LIGHTING

Interior mood lighting highlights many of the cabin's key features and design details in a relaxing soft Phosphor Blue glow.

INTELLIGENT STOP/START

Stop/Start is a technology that stops the engine when it is not needed, improving the fuel economy and reducing the car CO₂ emissions. The engine will restart as soon as the driver foot comes off the brake pedal. The engine will be operating at full capacity before the driver's foot has touched the accelerator pedal.

J

JAGUAR SIGNATURE 'J' BLADE DAYTIME RUNNING LIGHTS

'J' blade Daytime Running Lights are separate LED running lights, in a distinctive 'J' shape, built into the headlights. They emphasize the striking on-road style of Jaguar vehicles.

JAGUARDRIVE SELECTOR

The JaguarDrive Selector rises from the center console on start up. It is a rotary shifter that allows you to quickly shift between drive modes.

L

LED HEADLIGHTS

Multiple powerful LED emitters give a clearer light in low light conditions. Further complemented with LED 'J' blade Daytime Running Lights incorporating LED Direction Indicators. These lights also integrate the vehicle's Adaptive Lighting and Auto High Beam Assist (AHBA) systems.

M

MHL CONNECTION

A Mobile High-Definition Link (MHL) enables connection between a personal device and the InControl® infotainment system. It is designed for seamless transfer of audio-visual data.

10" MULTI-TOUCH DISPLAY

The multi-touch functionality of Touch Pro 10" display allows the screen to recognize multiple points of contact. This provides direct control of the system's features in a more natural, intuitive way, enabling gestures such as pinch and zoom.

R

RAIN ICE SNOW MODE

By selecting Rain/Ice/Snow mode, the system automatically dampens acceleration and applies more gradual torque for improved traction in slippery conditions.

S

SATELLITE VIEW

Satellite View allows you to view satellite imagery as an optional view mode for the navigation system.

SOLID STATE DRIVE

Solid State Drives are storage devices with no moving parts designed for rapid retrieval of large quantities of data.

SPEED LIMITER

The Speed Limiter, when selected, will assist in limiting vehicle speed to the speed limits as recognized by the Traffic Sign Recognition system.

V

12.3" VIRTUAL NAVIGATION MAP

The 12.3" virtual navigation map is a TFT (Thin Film Transistor) screen that replaces the traditional instrument cluster. It displays a wide range of key driving information. Four graphical themes and a 3D map view are available.



*DISCLAIMERS

¹ Do not use Jaguar InControl® features under conditions that will affect your safety or the safety of others. Driving while distracted can result in loss of vehicle control.

² Driving while distracted can result in loss of vehicle control. Do not operate, adjust or view the navigation or multimedia systems under conditions that will affect your safety or the safety of others. Only use mobile phones, and other devices, even with voice commands, when it is safe to do so.

³ The Wi-Fi Hotspot is intended for passenger use only. Jaguar InControl® features may require an additional subscription with separate terms and conditions.

⁴ A 3-month trial subscription to the SiriusXM® All Access package is included with the vehicle, which gives you access to 175+ channels of premium programming. Plus you can stream SiriusXM® on your computer, smartphone or tablet – it's included in your trial. If you decide to continue service after your trial, the subscription plan you choose will automatically renew thereafter and you will be charged according to your chosen payment method at then-current rates. Fees and taxes apply. To cancel you must call SiriusXM® at 1-866-635-2349. See the SiriusXM® Customer Agreement for complete terms at siriusxm.com. All fees and programming are subject to change. SiriusXM® Satellite Radio is not available in Alaska, Hawaii, or Puerto Rico.

⁵ These features are not a substitute for driving safely with due care and attention and will not function under all circumstances, speeds, weather and road conditions, etc. Driver should not assume that these features will correct errors of judgment in driving. Please consult the owner's manual or your local Jaguar Retailer for more details.

⁶ Please remember that the safety belts in a vehicle constitute the primary protection system for driver and passengers in collisions. Airbags are not designed to deploy in all collisions. The airbag Supplemental Restraint System (SRS) is a supplement to the safety belts and is designed to work as a system with the safety belts. Although airbags provide additional protection, airbags without safety belts do not provide optimal protection in a crash. Always wear your safety belts. Children younger than 13 years old should always be properly restrained in a back seat, away from airbags. Never place an infant seat in the front seat.

⁷ Always follow local speed limits.

⁸ Supports compatible music players.

⁹ Class is cars sold by luxury automotive brands and claim is based on total package of warranty, maintenance and other coverage problems. For complete details regarding Jaguar EliteCare coverage, visit JAGUARUSA.COM, call 1.800.4.JAGUAR or visit your local Jaguar Retailer. Servicing your vehicle at the specified interval is critical to maintaining its long-term durability. Failure to perform scheduled maintenance within 1,000 miles of the recommended interval may void the Warranty under certain circumstances.

Meridian is a trademark of Meridian Audio Limited.
The Bluetooth® word mark and logos are owned by the Bluetooth SIG, Inc. and any use of such marks by Jaguar Land Rover Limited is under license.
iPod, iPod touch and iPad are trademarks of Apple Inc, registered in the US and other countries.
©2017 Jaguar Land Rover North America, LLC

VEHICLES SHOWN FRONT COVER: XF SPORTBRAKE S IN YULONG WHITE AND XF SEDAN R-SPORT IN CORRIS GREY WITH OPTIONAL EQUIPMENT

VEHICLES SHOWN BACK COVER: XF SPORTBRAKE S IN YULONG WHITE AND XF SEDAN R-SPORT IN CORRIS GREY WITH OPTIONAL EQUIPMENT

IMPORTANT NOTICE

Jaguar Land Rover Limited is constantly seeking ways to improve the specification, design and production of its vehicles and alterations take place continually. While every effort is made to produce up-to-date literature, this brochure should not be regarded as an infallible guide to current specifications, nor does it constitute an offer for the sale of any particular vehicle. Distributors and Retailers are not agents of Jaguar Land Rover Limited by any express or implied undertaking or representation. Comparisons are based on manufacturer's own data and testing.

COLORS

Print and online colors are representative only.

ENVIRONMENTAL INNOVATION AT JAGUAR

Jaguar is proud to continue the company's tradition with its approach to Environmental Innovation. From the choice of lightweight materials and lean production methods to the efficiency of its engines and designs, Jaguar is committed to operating as a more sustainable business and reducing its overall environmental impact.

The company flagship model, the XJ model was the first in the company to achieve ISO14040, the international standard for vehicle 'life cycle assessment'. This certification measures the environmental impact of the XJ from component material sourcing and manufacturing process, through driving 124,000 miles. But that's not all. Every new Jaguar is designed to be 85% Recyclable/Reusable and 95% Recoverable at the end of the vehicle life.

The all-new XF, XE, XJ and F-TYPE innovative use of lightweight aluminum, which incorporates up to 50% closed-loop recycled material from the manufacturing process of the body structures, provides considerable performance benefits. This includes improved fuel consumption and less CO₂ emissions during the use phase of the Life Cycle due to lighter structures. Our on-going target is to ensure scrap aluminum reclaimed from our stamping process is to be segregated and recycled through a closed loop system and re-melted into the same grade quality sheet, therefore reducing CO₂ emissions during the production phase of the Life Cycle. Jaguar is committed to reducing dependency on fossil fuels, using fewer resources and creating less waste as part of our approach to sustainability excellence.

The company plan includes 25% reduction targets in operating and tailpipe CO₂ emissions, waste to landfill, logistics efficiencies (15%) and water consumption (10%), all based on per vehicle built since 2007. In addition the manufacturing assembly CO₂ emissions of each Jaguar built in the UK since 2009 is 100% offset. For each ton of CO₂ emitted in the assembly process, Jaguar invests in projects that reduce an equivalent ton of CO₂ elsewhere. Taking into account the company's global sales growth and increased investment in more efficient operating facilities, we are proud to have delivered and in some cases exceeded our Environmental Innovation targets as planned for 2012. And we are on track to meet our 25% reduction in joint European fleet average tailpipe CO₂ emissions by 2015.

Looking forward, we have developed our 2020 vision for sustainable business growth that focuses on continued improvements in tailpipe CO₂ emissions, operational carbon neutrality and zero waste. To date the company has offset over 6 million tons of CO₂, provided over 4,000 direct jobs in 60 emissions reduction projects in 17 countries and improved the lives of over 1 million people in our global cook stoves emissions reduction program.

But it doesn't stop there. Our manufacturing facilities have been certified to ISO14001 since 1998 and we are credited to Platinum Plus level in the UK's Business in the Community Corporate Responsibility Index.

Castrol EDGE™ Professional is recommended by Jaguar.

Jaguar Land Rover North America LLC
555 MacArthur Boulevard
Mahwah, NJ 07430-2327
JAGUARUSA.COM

1X2601820M00BUSEN01P

