

CONTENTS

PERSONALIZATION

LOCATE A RETAILER

BUILD YOURS

JAGUAR XJ 2018



THE ART OF PERFORMANCE





CONTENTS

PERSONALIZATION

LOCATE A RETAILER

BUILD YOURS



BY APPOINTMENT TO
HIS MAJESTY THE KING
MANUFACTURERS OF
MOTOR VEHICLES
JAGUAR LAND ROVER LIMITED
COVENTRY



BY APPOINTMENT TO
HIS MAJESTY THE KING
MANUFACTURERS OF
MOTOR VEHICLES
JAGUAR LAND ROVER LIMITED
COVENTRY



BY APPOINTMENT TO
HIS MAJESTY THE KING
MANUFACTURERS OF
MOTOR VEHICLES
JAGUAR LAND ROVER LIMITED
COVENTRY



THE ART OF PERFORMANCE

Every day we push performance to its limit. Our performance. Our cars' performance. We innovate, we engineer, we design. We master rules and then break them. Only to push further. Past the limits of convention. This is when performance becomes art.

Jaguar. The Art of Performance.





CONTENTS

INTRODUCTION		JAGUAR INCONTROL® TECHNOLOGIES	
The Concept of XJ	06	Infotainment and Connectivity	40
The XJ - The Facts	08	Touch Pro and Connect Pro Audio	43 44
DESIGN		ASSISTANCE AND EFFICIENCY	
Exterior Principles	10	Driver Assistance	46
Exterior - A Powerful Look	13	Efficient Technologies	48
Exterior View	15	PERSONALIZATION	
Interior Technology	17	The XJ - Your Choice	50
Interior Luxury	18	Choose your Engine	52
Interior Comfort	21	Choose your Model & Packages	54
Interior Space	23	Choose your Color	62
PERFORMANCE		Choose your Wheels	64
Engines	24	Choose your Interior	66
All-Aluminum Body	26	Choose your Jaguar Gear	80
Advanced Driving Dynamics	28	Technical Specifications	82
XJR575 - The Most Powerful and Agile XJ	33	Dimensions	84
XJR575 - Sporting Style	35	SPECIAL VEHICLE OPERATIONS	86
DRIVING TECHNOLOGY		THE WORLD OF JAGUAR	88
Added Driver Assistance	36	Glossary and Legal Information	90
Advanced Drivetrain Technology	38		



Scan to find out more about the Jaguar XJ.

VEHICLE SHOWN: XJ SUPERCHARGED IN SANTORINI BLACK WITH OPTIONAL EQUIPMENT
 VEHICLES SHOWN ARE FROM THE JAGUAR GLOBAL RANGE. SPECIFICATIONS, OPTIONS AND AVAILABILITY WILL VARY BETWEEN MARKETS AND SHOULD BE VERIFIED WITH YOUR LOCAL JAGUAR RETAILER





INTRODUCTION THE CONCEPT OF XJ

The pinnacle sedan car of the Jaguar line-up, the XJ is the perfect combination of cutting edge technology, sporting vehicle dynamics, and opulent luxury. In the cabin, there's space to stretch out, relax or work using our latest connected technology, Touch Pro*¹. With the new 10" Touchscreen and the availability of 4G Wi-Fi Internet, the XJ has everything you need to make your journey more productive, entertaining and relaxed.

Always working with you, is an enhanced suite of available Advanced Driver Assist Systems including, Lane Keep Assist and Adaptive Cruise Control with Queue Assist*⁵. While energy-efficient full-LED headlights, standard on every XJ, produce piercing beams of light with a quality close to daylight for better visibility at night.

Now, the most powerful XJ ever joins the range - XJR575. Its assertive presence only hints at the power within: 575HP and 517 lb-ft of torque can take this luxury sedan to a top speed of 186 mph*⁸. XJR575 is XJ at its most dynamic and intense.

*Please see page 90 for further information.

VEHICLE SHOWN: XJL PORTFOLIO IN LOIRE BLUE WITH OPTIONAL EQUIPMENT



CONTENTS

PERSONALIZATION

LOCATE A RETAILER

BUILD YOURS

THE XJ - THE FACTS

The technology developed by Jaguar is focused on enhancing the journey for you and your passengers. Dynamic systems assist performance, handling and comfort. The XJ also features the latest connected technology, powerful engines and an array of luxury interior choices.

JAGUAR ELITECARE
**BEST IN CLASS
COVERAGE**
5 YEARS 60,000 MILES

JAGUAR ELITECARE

Enjoy your Jaguar with complete peace of mind. The XJ is backed by the Best-In-Class Jaguar EliteCare^{®9}, our exceptional 5 year / 60,000 mile coverage program including New Vehicle Limited Warranty, Complimentary Scheduled Maintenance, Roadside Assistance and Jaguar InControl[®] Remote & Protect[™].

As we roll out InControl, specific features described may be optional or powertrain dependent. Please consult your country-specific Jaguar website or local Jaguar Retailer for availability and full terms in your country. Certain features require a Micro SIM with a suitable data contract which will require further subscription after the initial term advised by your Retailer. Mobile connectivity cannot be guaranteed in all locations.

*Please see page 90 for further information.

VEHICLE SHOWN: XJR575 LONG WHEELBASE IN SATIN CORRIS GREY WITH OPTIONAL EQUIPMENT

CONNECTED CAR

Connect Pro is a package of applications and technologies that keeps the XJ connected to the world. It runs a suite of useful smartphone apps from the new 10" Touchscreen^{*1}. The Connect Pro services, technologies and applications give you the very best in connectivity and convenience, all supported by a fast 4G Wi-Fi Internet connection through a powerful external antenna. With Remote you can connect to, and monitor, your Jaguar XJ from anywhere and even pre-heat or cool the cabin before entering.

TOUCH PRO

Putting all the essential in-car controls and a world of entertainment at your fingertips is the next-generation XJ Touch Pro infotainment system, part of Jaguar InControl[®] technologies. It features Bluetooth[®] connectivity and a larger 10" tablet-style Touchscreen with intuitive swipe and pinch-to-zoom navigation^{*1}.

COLORS AND MATERIALS

XJ provides true luxury choice throughout. A wealth of colors and wheels are available, including two exterior colors exclusive to the XJR575 – Satin Corris Grey and Velocity Blue. Choose a Portfolio, XJL Supercharged or XJR575 model and you will discover beautiful soft grain leather seats defined in a Diamond quilted contrast stitched pattern. Exclusive color coordination continues throughout the cabin.

PERFORMANCE AND EFFICIENCY

Powerful and refined, for a thrilling and rewarding drive. The XJ offers two highly advanced engines – 3.0 V6 and 5.0 V8. The 5.0 V8 engine is available in two power outputs – 470HP and 575HP, achieving 0-60 mph in as low as 4.2 seconds^{*8}. Featuring an 8-speed automatic transmission with Intelligent Stop/Start technology.

ALL-ALUMINUM CONSTRUCTION

The XJ all-aluminum body architecture is designed to be strong and rigid but also extremely light making the car highly responsive and agile, as well as fuel efficient. Riveted, and without a single welded joint, the 100 percent aluminum monocoque body structure makes the car lighter and without compromise to the integrity of its body.

'DOUBLE J' HEADLIGHTS

Jaguar's unique 'Double J' Daytime Running Lights give the XJ a distinctive appearance. The full LED headlights supply a 'whiter' light than conventional Xenon beams. Being closer to daylight, objects can be better recognized, helping increase comfort and visibility during night driving.





DESIGN EXTERIOR PRINCIPLES

▶ DESIGN PURITY | **POWERFUL STANCE**

The XJ stands out: authoritative, elegant, and powerful. The teardrop shape is formed for optimum aerodynamic efficiency, reducing air resistance to a minimum, improving acceleration. The shape is the result of exhaustive computational modeling where aesthetics and aerodynamics work together. The chrome outlined side windows emphasize the pure, elongated form of the XJ. The low, wide stance and long, taut waistline create a commanding presence, while inside the cabin still feels airy and spacious thanks to its panoramic roof and smart design.

VEHICLE SHOWN: XJL PORTFOLIO IN LOIRE BLUE WITH OPTIONAL EQUIPMENT





EXTERIOR - A POWERFUL LOOK

> BOLD FRONT GRILLE | 'DOUBLE J' HEADLIGHTS

The assertive front styling includes an upright front grille design with mesh detail. The grille is framed by energy efficient full-LED headlights, sporting unique Jaguar 'Double J' Daytime Running Light design. Producing a light with a color temperature closer to natural daylight, objects can be better recognized helping increase comfort and visibility during night driving.

At the rear, finishing touches include elliptical tailpipes and LED tail lights incorporating a distinctive pinstripe graphic that provides a crisp and clear 'ribbon of light'. The LED tail lights are brighter, more efficient and illuminate faster than halogen bulbs contributing to the overall drive for greater efficiency.

VEHICLE SHOWN: XJ SUPERCHARGED IN SANTORINI BLACK WITH OPTIONAL EQUIPMENT



EXTERIOR VIEW

FULL WIDTH PANORAMIC ROOF

The view from inside XJ is extensive: a panoramic, full width, heat-reflective glass roof sweeps back and over the rear seats. It filters UV rays and floods the interior with natural light making it feel airy, spacious and, thanks to effective tinting, very private. Power operated blinds allow you to completely block the light when required. Specially formulated toughened glass helps to keep the cabin cool.

VEHICLE SHOWN: XJL PORTFOLIO IN CARPATHIAN GREY WITH OPTIONAL EQUIPMENT



INTERIOR TECHNOLOGY

➤ **CONNECTED INFOTAINMENT** | **ADVANCED GRAPHICS**

The high-definition Interactive Driver Display puts everything you need to know about your driving right in front of you. The 12.3" screen displays the speed, fuel and temperature gauges and can be set to display the most relevant information, depending on the situation and set up. This multi-layered virtual display combines a user-friendly graphical interface with advanced functionality to make finding the right settings even easier.

The Interactive Driver Display is fully integrated with the 10" Touchscreen to put all information behind the wheel or on the center console. For example, when working with Navigation Pro the Interactive Driver Display can be reconfigured to show 3D mapping, making following your route even simpler*1.

As we roll out InControl, specific features described may be optional, and market or powertrain dependent. Please consult your country-specific Jaguar website or local Jaguar Retailer for availability and full terms in your country. Certain features require a Micro SIM with a suitable data contract which will require further subscription after the initial term advised by your Retailer. Mobile connectivity cannot be guaranteed in all locations.

*Please see page 90 for further information.
INTERIOR SHOWN: XJL PORTFOLIO SHOWING IVORY SOFT GRAIN PERFORATED LEATHER SEATS WITH EBONY CONTRAST STITCH, EBONY UPPER FASCIA, EBONY SUEDE/CLOTH HEADLINING AND GLOSS BURL WALNUT VENEER WITH OPTIONAL EQUIPMENT

INTERIOR LUXURY

[▶ CRAFTSMANSHIP](#) | [EXTENSIVE CHOICE](#)

The quality of craftsmanship throughout the XJ cabin sets it apart. With a wide choice of colors, materials and finishes, the interior reflects the clarity and purity of the XJ exterior. The hand-crafted veneer that runs right around the cabin accentuates the sense of space. The sporting character of Jaguar is present in the controls and architecture surrounding the driver including the leather-wrapped, three-spoke steering wheel that offers key controls at your fingertips.



INTERIOR SHOWN: INTERIOR SHOWN: XJL PORTFOLIO WITH OPTIONAL PREMIUM REAR SEAT PACK SHOWING IVORY SOFT GRAIN PERFORATED LEATHER SEATS WITH EBONY CONTRAST STITCH, EBONY UPPER FASCIA, EBONY SUEDECLOTH HEADLINING AND GLOSS BURL WALNUT VENEER WITH OPTIONAL EQUIPMENT



INTERIOR COMFORT

- [FRONT PASSENGER SEAT AWAY](#)
- [HEATING AND COOLING FUNCTIONS](#)
- [MASSAGE SEATS](#)

The multi-functional seating in the XJ gives you complete control of your comfort. Both front seats feature fine-tuned electric adjustment and can be specified with five different massage programs. Both front and rear seats are heated. All seats feature a cooling function as well. Some XJ models also offer three position user memory on the driver and front passenger seats. Long Wheelbase models can be further enhanced with a choice of Rear Seat Option Packages, featuring two individual airline-style reclining seats complete with three massage programs and memory. The reclining rear seats can be programmed to return to an upright position when the door is opened and a 'front passenger seat away' function allows rear occupants to move the empty front passenger seat forward to increase legroom and aid access.

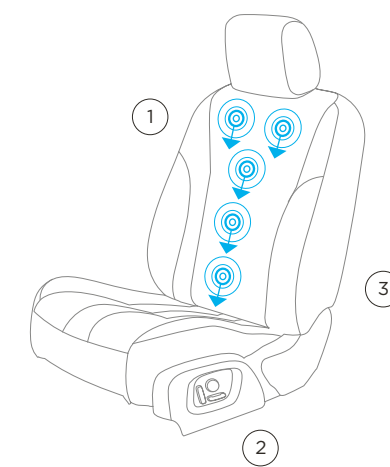

FRONT SEATS

Available with five different massage programs, electric adjustment with three position memory and heated/cooling function.

1. Five massage programs
2. Three position memory function
3. Cooling function

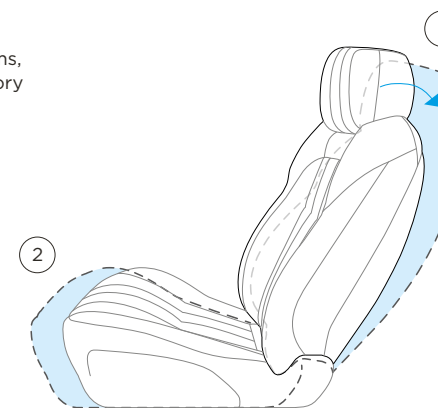

REAR SEATS

Available on Long Wheelbase models with airline-style recline, three different massage programs, electric adjustment with two position memory.

1. Total recline movement is 11 degrees
2. 4 inches of longitudinal cushion movement and separate 14.5 degrees of upper articulation movement

INTERIOR SHOWN: XJL PORTFOLIO WITH OPTIONAL PREMIUM REAR SEAT PACK SHOWING IVORY SOFT GRAIN PERFORATED LEATHER SEATS WITH EBONY CONTRAST STITCH, EBONY UPPER FASCIA, EBONY SUEDECLOTH HEADLINING AND GLOSS BURL WALNUT VENEER WITH OPTIONAL EQUIPMENT



1. LWB headroom 37.2" 2. LWB knee room 7.4"

INTERIOR SPACE

> OVER THREE FEET OF LEGROOM | LIMOUSINE RIDE

Long Wheelbase models feature over three feet of legroom for rear seat passengers providing the perfect environment to work, enjoy a host of entertainment options, or simply stretch out and relax. Long Wheelbase models also feature a unique 'limousine' ride with revised air suspension settings for even more refined comfort.

Depending on the model, or options chosen, the rear cabin can be further enhanced with individual 10.2" HD screens. The center armrest houses the multimedia remote and front and rear seat controls, as well as providing useful storage. Folding business tables, LED reading lights, drop-in footrests and electric side rear window blinds are also available to add comfort, convenience and privacy.

INTERIOR SHOWN: XJL PORTFOLIO WITH OPTIONAL PREMIUM REAR SEAT PACK SHOWING IVORY SOFT GRAIN PERFORATED LEATHER SEATS WITH EBONY CONTRAST STITCH, EBONY UPPER FASCIA, EBONY SUEDECLOTH HEADLINING AND GLOSS BURL WALNUT VENEER WITH OPTIONAL EQUIPMENT

PERFORMANCE ENGINES

▶ STOP/START TECHNOLOGY

The XJ offers two highly advanced engines – 3.0 liter V6 and 5.0 liter V8. Each features a Roots-type twin vortex supercharger that maintains the engines' compact dimensions.



V6 ENGINE

0-60 mph from 5.7 sec*7

Powerful and refined, for a thrilling and rewarding drive. The compact supercharger's sophisticated boost control and secondary throttle valve give you a burst of power when you accelerate, with minimal lag. The water-cooled intercooler reduces air intake temperature for more power and efficiency. The XJ 3.0 liter 340HP Supercharged engine offers economy and performance, achieving 0-60 mph in 5.7 seconds*7 due to its 332 lb-ft of torque.

The engine uses an 8-speed automatic transmission and also includes Stop/Start technology.

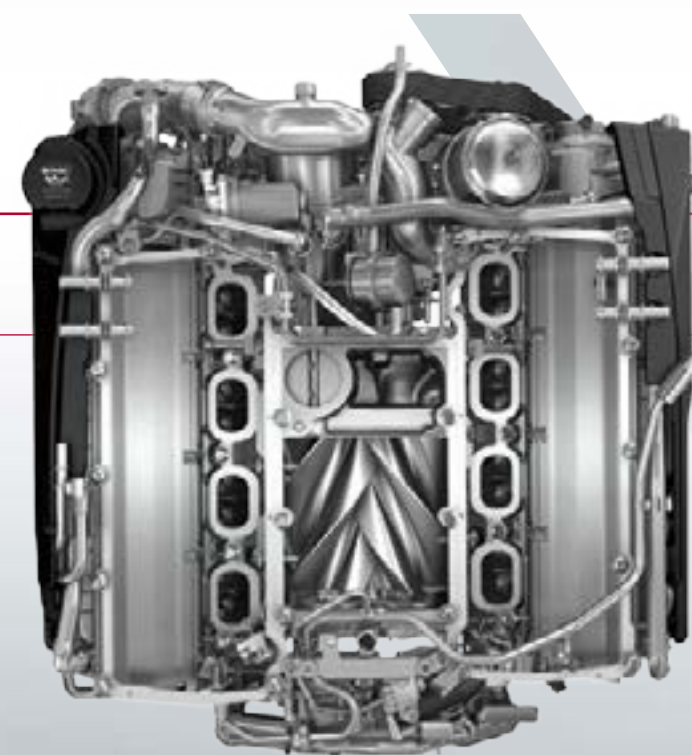

V8 ENGINES

0-60 mph from 4.2 sec*7

Lightweight and powerful, this engine features die-cast aluminum blocks to reduce weight. Dual independent variable cam timing optimizes power at any speed. Cleaner, more efficient combustion is achieved by spray-guided direct injection of precisely measured quantities of fuel directly into the center of the combustion chamber. The 5.0 liter V8 engine is available in two power outputs – 470HP and 575HP. The 5.0 liter V8 470HP creates 424 lb-ft of torque. 0-60 mph acceleration is achieved in 4.9 seconds*7. The 5.0 liter V8 575HP has been modified to create 517 lb-ft of torque. 0-60 mph acceleration is achieved in 4.2 seconds with a top speed of 186 mph*7.

*Please see page 90 for further information.

ALL-ALUMINUM BODY

➤ **AGILITY ENHANCED** | **ECONOMY IMPROVED** | **100% ALUMINUM**

The all-aluminum body, the core of its dynamic performance is stiff, strong and light architecture. Developed using aerospace bonding and riveting techniques, the 100 percent aluminum monocoque body structure of the XJ does not have a single welded joint. With up to 50 percent of the aluminum coming from recycled sources, the XJ leads the way in sustainability.

The power-to-weight ratio improves all aspects of performance without compromising its strength. Acceleration is improved, and because the engine has to work less, it lowers fuel consumption and emissions. Its aluminum construction also enhances ride comfort, handling, agility and feel, connecting the driver seamlessly to the car and the road.

The inherent strength of aluminum and the monocoque construction offer safety benefits too. The lower weight improves braking performance and reduces the kinetic energy involved in almost any impact. Aluminum absorbs significantly more energy than steel when it is deformed and, because there are fewer joints, the XJ strength is increased further still.

VEHICLE SHOWN: XJL PORTFOLIO IN LOIRE BLUE WITH OPTIONAL EQUIPMENT



ADVANCED DRIVING DYNAMICS

[▶ AIR SUSPENSION SYSTEM](#) | [ADAPTIVE DYNAMICS](#)

The XJ delivers the comfort and refinement of a luxury car with the responsiveness and driver involvement of a sports car. Whether you're cornering, navigating uneven surfaces or accelerating, the Adaptive Dynamics system continually monitors the car up to 500 times a second. Working in conjunction with the air suspension it is designed to vary the damping to suit the conditions. These intelligent adjustments are designed to keep the XJ flat and stable, and to improve control without loss of ride comfort*⁵. In unexpected road and weather conditions, Dynamic Stability Control is designed to react as soon as the system detects the wheels slipping. Trac DSC provides a sportier drive and assists when using snow chains by allowing some slippage or overspin before the system engages*⁵. The XJ also features selectable driving modes for specific performance requirements. In addition to 'Drive' and 'Sport', Dynamic Mode gives more responsive acceleration; Winter Mode is designed to deliver more progressive control in slippery conditions*⁵.

*Please see page 90 for further information.
VEHICLE SHOWN: XJL PORTFOLIO IN CARPATHIAN GREY WITH OPTIONAL EQUIPMENT







XJR575 - THE MOST POWERFUL AND AGILE XJ

5.0 LITER SUPERCHARGED V8 | ELECTRONIC ACTIVE DIFFERENTIAL

The breathtaking power and razor-sharp responsiveness of the XJR575 helps deliver new levels of dynamic ability in a luxury sedan car. It is the epitome of technology, performance and seductive design – everything Jaguar stands for in the 21st century. This flagship Jaguar has extraordinary performance with a stealthy, purposeful appearance. The 5.0 liter Supercharged V8 engine at its heart generates a formidable 575HP and 517 lb-ft torque, powering XJR575 to a top speed of 186 mph*⁸.

Capable of accelerating from 0-60 mph in just 4.2 seconds*⁸, the driving dynamics of the XJR575 are assisted by an innovative Electronic Active Differential*⁵. This technology enables fine control of power delivery, designed to enhance traction and limit the occurrence of wheelspin. Working in conjunction with the Dynamic Stability Control and ABS systems, the Electronic Active Differential uses an electric motor, acting on a multi-plate clutch to manage the delivery of torque to the rear wheels*⁵. Full electronic control of the rear differential lock enables the system to apply full locking torque almost instantaneously, allowing the driver to exploit the thrilling performance potential of XJR575.

Subtle exterior design cues optimize the flow of air over and around the car, and signify the sporting intent of this most focused, agile and responsive member of the XJ family. The XJR575 is given even more visual muscularity by a revised rear spoiler, side sills, front hood, splitter and lower air intakes featuring Gloss Black surrounds.

Unique exterior styling includes XJR575 badging and twin hood vents, as well as Red painted brake calipers and 20" 5 spoke 'Style 5044' Forged alloy wheels finished in Gloss Black. Also available as a visual enhancement are Satin Corris Grey and Velocity Blue high quality Special Vehicle Operations Premium Palette paint finishes.

*Please see page 90 for further information.
VEHICLE SHOWN LEFT AND PREVIOUS PAGE: XJR575 STANDARD WHEELBASE IN SATIN CORRIS GREY WITH OPTIONAL EQUIPMENT



XJR575 - SPORTING STYLE

> SOFT GRAIN LEATHER SPORT SEATS

The XJR575 offers an unrivalled combination of sporting style, contemporary luxury and breathtaking performance. Its sports seats feature adjustable bolsters that provide the driver and passenger with lateral support during hard cornering. They are upholstered in soft grain leather offered in two bold color combinations, either Ebony with Pimento stitch or Ivory with Ebony stitch. This is complemented with a Carbon Fiber veneer or optional Piano Black veneer. The XJR575 logo appears on the treadplates, dashboard Intaglio and is embroidered on the front and rear seats.

INTERIOR SHOWN: XJR575 LONG WHEELBASE WITH EBONY SOFT GRAIN LEATHER SPORTS SEATS WITH PIMENTO CONTRAST STITCH, EBONY UPPER FASCIA, EBONY SUEDECLOTH HEADLINING, CARBON FIBER VENEER AND EBONY PREMIUM CARPET MATS WITH PIMENTO CONTRAST BINDING WITH OPTIONAL EQUIPMENT

DRIVING TECHNOLOGY ADDED DRIVER ASSISTANCE

ALL SURFACE PROGRESS CONTROL

Standard on every XJ, the Jaguar All Surface Progress Control (ASPC) technology is a low speed cruise control that helps the car to cope with low traction situations. ASPC allows the driver to concentrate on steering the vehicle. Once activated, you use the cruise control buttons to set a 'target' speed of between 2.2 mph and 18.6 mph*⁸.

The system then works to achieve and maintain that speed while exerting optimum traction control. ASPC gives XJ drivers added confidence over slippery, loose surfaces, undulating terrain and even while descending a difficult incline*⁵.



GRAVEL

WET GRASS

SNOW/ICE

WET ROAD

*Please see page 90 for further information.

With any given set of tires, ASPC can accomplish comparable levels of traction. Fitting All Season or Winter tires to XJ can improve capability on slippery surfaces.

ADVANCED DRIVETRAIN TECHNOLOGY

▶ ALL WHEEL DRIVE |
 OVER 90% TORQUE SPLIT |
 INTELLIGENT AND ADAPTIVE

The optional Jaguar Instinctive All Wheel Drive® system is continuously variable and intelligent. The rear wheel bias ensures a consistently true Jaguar driving experience. In normal conditions an XJ with the AWD system behaves like a rear wheel drive vehicle but reacts intelligently to road conditions to deliver traction on demand. The AWD system reacts in the blink of an eye, so should the rear wheels start to slip, it is designed to instantly redistribute torque to compensate. Over 90 percent of engine torque can be distributed from the rear wheels to the front wheels to provide optimum traction. It offers a smoother drive with the familiar Jaguar agility and handling*⁵.

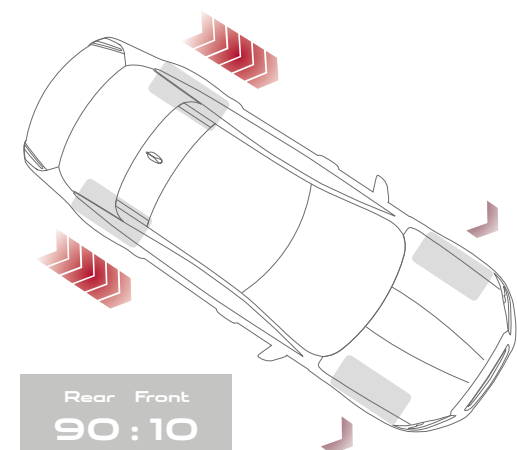

DRY ROAD CONDITIONS

In normal driving conditions, virtually all torque is distributed to the rear wheels providing signature Jaguar rear wheel drive performance.

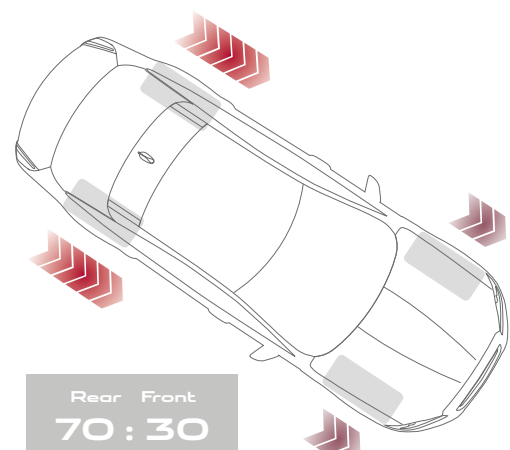

AWD WINTER MODE

At the touch of a button AWD Winter Mode can be selected to distribute 30 percent of the torque to the front wheels and 70 percent of the torque to the rear wheels for improved assistance in difficult conditions*⁵.

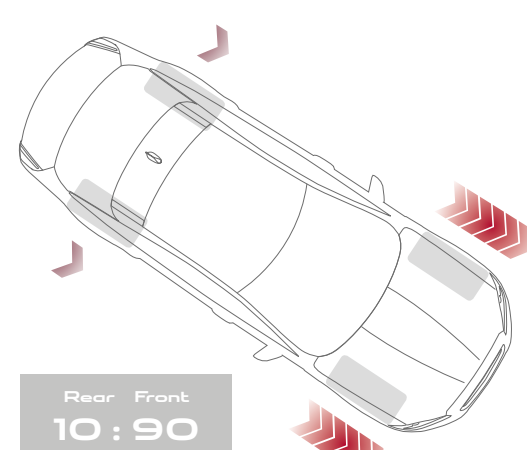

VARIABLE ROAD CONDITIONS

Where road conditions are changeable, over 90 percent of torque can be distributed to the front wheels as required.

*Please see page 90 for further information.

VEHICLE SHOWN: XJL PORTFOLIO IN LOIRE BLUE WITH OPTIONAL EQUIPMENT



JAGUAR INCONTROL® TECHNOLOGIES INFOTAINMENT AND CONNECTIVITY

➤ [TOUCH PRO](#) | [CONNECT PRO](#)

InControl is our suite of advanced technologies that links both you and your XJ to the wider world. XJ features the Touch Pro infotainment system, now with the full 10" Touchscreen, and the connectivity package: Connect Pro*1.

TOUCH PRO*1



STANDARD ON EVERY XJ

10" Touchscreen with multi-touch gestures and customizable home screen

12.3" Interactive Driver Display with virtual dials and full screen 3D Map View

Navigation Pro

FM Radio, Bluetooth® and 2 x USB connections

CD/DVD Drive



Connect Pro consists of InControl Apps, Remote Premium smartphone app, Wi-Fi Hotspot*3 and Pro Services



Protect consists of SOS Emergency Call, Jaguar Optimized Assistance and Remote smartphone app

⚙️ For information on Connect Pro see page 43.

*Please see page 90 for further information.

As we roll out InControl, specific features described may be optional, and market or powertrain dependent. Please consult your country-specific Jaguar website or local Jaguar Retailer for availability and full terms in your country. Certain features require a Micro SIM with a suitable data contract which will require further subscription after the initial term advised by your Jaguar Retailer. Mobile connectivity cannot be guaranteed in all locations.

VEHICLE SHOWN: XJL PORTFOLIO IN CARPATHIAN GREY WITH OPTIONAL EQUIPMENT



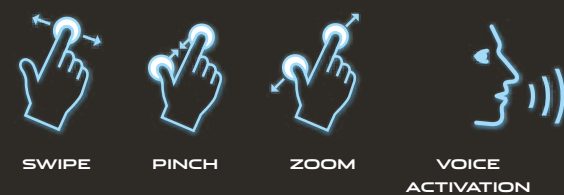

TOUCH PRO

➤ NEXT GENERATION INFOTAINMENT

The next-generation hardware and software of Touch Pro advances your vehicle's connectivity and entertainment to the very highest level. The key aspects of Touch Pro*¹ are:

Large, highly-responsive, 10" Touchscreen at the heart of the center console with customizable home screens and fast response times*¹.

Pinpoint touch control allows you to manipulate and interact with information swiftly and seamlessly. The Touchscreen responds in the same manner as a smartphone or tablet computer, supporting a range of multi-touch gestures such as pinch, zoom and swipe*¹.

12.3" Interactive Driver Display with virtual dials and full screen 3D Map View makes driving even more of a pleasure. Select full screen 3D Map View or choose one of four graphical themes to suit your personal preference*¹.

Navigation Pro offers response times that are a fraction of conventional systems. Set a destination and the system alerts you if you have insufficient fuel for the journey. It then displays gas stations on the part of the route where you may be low on fuel. The system also automatically displays parking options*¹.

CONNECT PRO

➤ ENHANCED CONNECTIVITY PACKAGE

The services, technologies and applications of Connect Pro give you the very best in connectivity and convenience. It offers many features including:

InControl Apps™ features a range of Jaguar approved apps that can be connected to the XJ from your smartphone. It ensures convenient use of apps optimized to enhance aspects of your in-car experience*¹.

Remote is an app that allows you to monitor as well as interact with your XJ from your smartphone. Remote start the XJ to pre-condition the cabin climate, lock and unlock the car, locate your XJ on a map or by using the beep and flash function, and track your trips.

Wi-Fi Hotspot gives you the option to create a strong 4G hotspot using the car's antenna when you fit a SIM card. Connect up to eight devices to read emails, browse the web and download content*³.

Pro Services is a comprehensive suite of connected services that includes:

InControl Route Planner App allows you to pre-plan your route via your Apple® or Android™ smartphone. It guides you to your car, where you will find your selected route available on the XJ Touchscreen*¹. When you've completed your trip, the app guides you to your destination.

Share your estimated time of arrival so your selected contact(s) will know when you will arrive, as calculated by the navigation guidance system. The system can then send automatic updates via text or email, without any further action from you*¹.

Commute Mode allows the system to learn your commutes and automatically advises you of the expected trip time and quickest routes based on live and historical traffic movements.

Arrival Mode displays interactive 360° street level imagery of your destination for a seamless finish to trips. It automatically displays again upon your arrival.

Real Time Traffic Information uses live traffic data feeds to give you the most accurate picture of what the traffic is like on the way to your destination.

Explore InControl at jaguarusa.com/incontrol

As we roll out InControl, specific features described may be optional, and market or powertrain dependent. Please consult jaguarusa.com or local Jaguar Retailer for availability and full terms in your country. Certain features require a Micro SIM with a suitable data contract which will require further subscription after the initial term advised by your Jaguar Retailer. Mobile connectivity cannot be guaranteed in all locations.

*Please see page 90 for further information.

AUDIO

➤ **MERIDIAN™** | **TRIFIELD™** | **CONVERSATION ASSIST**

Designed for XJ by Meridian, the British audio experts, two fully Digital systems are available: the Meridian 825W Digital Surround Sound System and the Meridian Reference 1300W Digital Sound System. All feature advanced technology including Digital Sound Processor (DSP) software to create high fidelity sound throughout the cabin and optimize every element of the system, as well as Meridian Cabin Correction (MCC) to improve the clarity and authentic reproduction of your music.

The Meridian 825W Digital Surround Sound System uses 20 speakers including 2 subwoofers with Audyssey MultEQ Sound Equalization technology to produce 7.1 surround sound, with Meridian's exclusive Trifield technology ensuring a perfect stereo image for each occupant wherever they are seated.

The optional Meridian Reference 1300W Digital Sound System using 26 speakers. This ultra-premium sound system employs Psychoacoustics to produce sounds that are so true to life they are perceived by the brain as the real thing.

You can hold a meeting or have an informal chat without ever having to raise your voice. Conversation Assist, included as standard with the Meridian Reference 1300W Digital Sound System, allows the driver or front seat passenger to talk with ease to passengers in the rear of the car, and vice versa. Microphones above each seat reinforce the occupants' voices via the audio system's speakers, making it much easier for everyone to be heard.

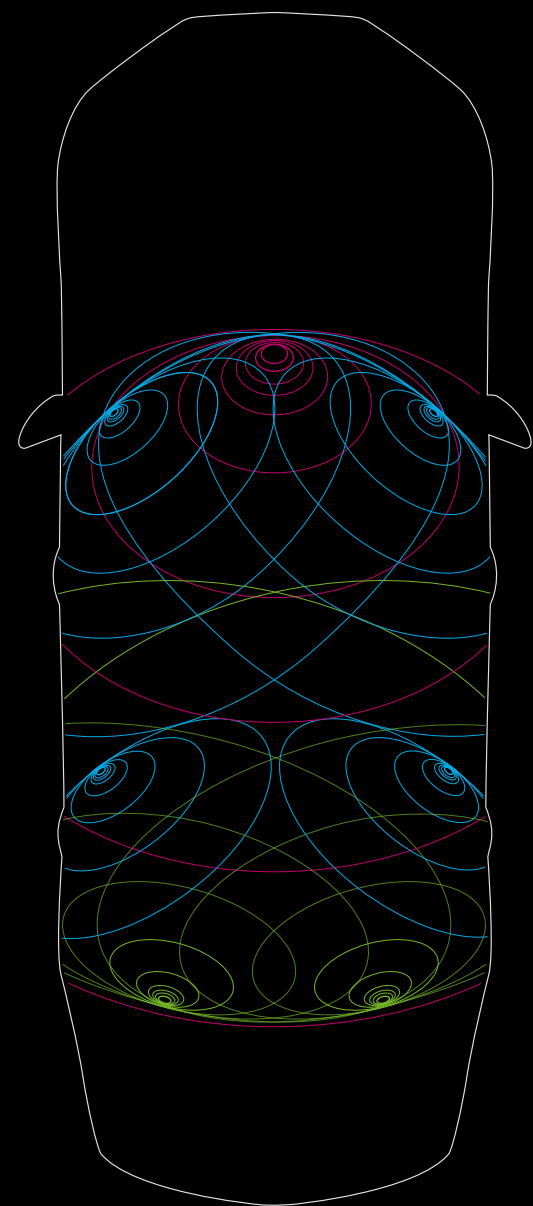

- Holographic Centre Image
- Door Waves: Tweeter, Midrange & Bass
- Surround Sound Waves

Diagram representative of Meridian 825W Surround Sound System.



825

WATTS

20

SPEAKERS

15

AMPLIFIER CHANNELS

MERIDIAN SURROUND SOUND SYSTEM

825W,
20 speakers,
15 channel class D DSP amplifier,
Audyssey MultEQ Audio Equalization,
7.1 Surround Sound,
Trifield technology



1300

WATTS

26

SPEAKERS

17

AMPLIFIER CHANNELS

MERIDIAN REFERENCE SOUND SYSTEM

1300W,
26 speakers,
17 channel class D DSP amplifier,
Audyssey MultEQ Audio Equalization,
7.1 Surround Sound,
Trifield technology,
Conversation Assist

*Trifield' and the 'three fields' device are trademarks of Trifield Productions Ltd.

ASSISTANCE AND EFFICIENCY DRIVER ASSISTANCE

The XJ is equipped with an array of standard and optional Advanced Driver Assist Systems dependent on model chosen. All are designed to make driving easier.



360° PARKING AID**

360° Parking Aid uses ultrasonic sensors to the front, rear and sides of the vehicle to alert you to the proximity of objects when parking or exiting from a spot*⁵.



ADAPTIVE FRONT LIGHTING

Adaptive Front Lighting adapts to steering inputs to cast a deeper beam into corners, while its Intelligent High Beam can detect oncoming vehicles and automatically selects high or dipped beam as appropriate*⁵.



REVERSE TRAFFIC DETECTION

Reverse Traffic Detection is particularly useful when reversing out of a parking spot, the system is designed to warn you of vehicles, pedestrians or other hazards, approaching from either side of your vehicle. It will alert you with both audio and visual warnings even when the view is obstructed*⁵.



TRAFFIC SIGN RECOGNITION AND ADAPTIVE SPEED LIMITER

Traffic Sign Recognition technology can detect current speed limit signs to display them on the Interactive Driver Display. This smart system is also aware of local and conditional speed limits. When activated, our Adaptive Speed Limiter uses Traffic Sign Recognition information to adjust your car's speed accordingly*⁵.



BLIND SPOT MONITOR

Blind Spot Monitor is designed to warn you of vehicles in, or quickly approaching your blind spot. When a vehicle is detected, a small warning light will illuminate in the corresponding side mirror. If you indicate in the direction of the obstacle, the warning light will flash to highlight potential danger*⁵.

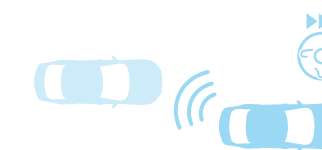

BLIND SPOT ASSIST†

If your vehicle detects another car in your blind spot when you begin to change lanes, this system is designed to provide precisely calculated steering torque - guiding your car away from the approaching vehicle*⁵.

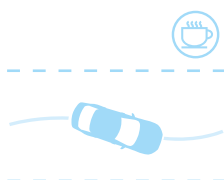

DRIVER CONDITION MONITOR†

Driver Condition Monitor detects if you're starting to feel drowsy or fatigued - giving you an early warning when you need to take a break*⁵.



PARK ASSIST***

Park Assist makes life easier. The system works for both parallel and perpendicular parking and is designed to automatically steer the XJ into and out of a space while the driver operates the pedals*⁵.

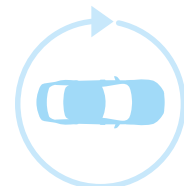

SURROUND CAMERA SYSTEM**

Provides a 360° exterior view via the Touchscreen, helping with various maneuvers from parking by a curb, to getting in and out of tight spaces*⁵.

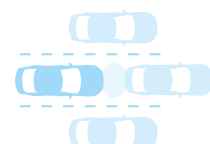

ADAPTIVE CRUISE CONTROL WITH QUEUE ASSIST**

Adaptive Cruise Control with Queue Assist is designed to keep your vehicle a set distance from the one in front should it slow or stop when you're cruising on the highway or travelling in slow-moving traffic. Should the vehicle in front stop completely, the system can provide assistance to reduce the stopping distance. Once the traffic moves, simply touch the accelerator and Adaptive Cruise Control will resume following the car in front. The system can be activated from 9.9 mph up to highway speeds*⁵.

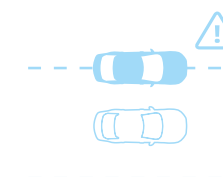

LANE DEPARTURE WARNING†

Lane Departure Warning can help make long trips more enjoyable. It senses when your car is unintentionally drifting out of your lane, and notifies you with a visual alert and a gentle vibration of the steering wheel*⁵.

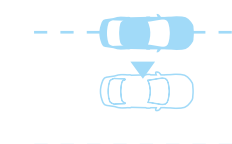

LANE KEEP ASSIST†

Working in conjunction with Lane Departure Warning, Lane Keep Assist can sense when your car is unintentionally drifting out of your lane, and is designed to gently steer you back*⁵.

*Please see page 90 for further information. **Optional feature. †Available on Rear Wheel Drive (RWD) models only.

EFFICIENT TECHNOLOGIES

[▶ STOP/START TECHNOLOGY](#) | [CLEAN TECHNOLOGIES](#)

We are determined to do more with less. That is why the XJ uses a range of technologies to help reduce fuel consumption and CO₂ emissions, all while staying true to the dynamic nature of Jaguar.



STOP/START TECHNOLOGY

The XJ engines come with Stop/Start technology. It shuts down the engine when you come to a complete halt and restarts the engine immediately when required, helping to save fuel, especially during city driving.



ELECTRIC POWER ASSISTED STEERING (EPAS)

The next generation Electric Power Assisted Steering (EPAS) offers outstanding feedback, control and immediate power assistance*⁵. Electrically driven, it's only active on demand which helps to save fuel. Only available on rear wheel drive vehicles.



AERODYNAMICS

The highly efficient shape of the XJ is the result of hundreds of thousands of hours of Computational Fluid Dynamics testing. Jaguar created one of the world's most advanced automotive virtual testing labs, honing the XJ shape through virtual wind tunnels to slice through wind resistance.



ALUMINUM ARCHITECTURE

The All-Aluminum architecture of the XJ makes it a lighter vehicle, meaning less fuel is needed to move it and consequently creating lower emissions.

*Please see page 90 for further information.



PERSONALIZATION THE XJ - YOUR CHOICE

Configure your vehicle at JAGUARUSA.COM



CHOOSE YOUR ENGINE

Page 52

Select a powerful XJ engine to suit your driving style.

CHOOSE YOUR MODEL & PACKAGES

Page 54

Compare the wealth of standard features and options on XJ models.

CHOOSE YOUR COLOR

Page 62

Express your individuality with one of the stunning XJ exterior colors.

CHOOSE YOUR WHEELS

Page 64

Add the personal finishing touch to your new XJ, and complement its stunning style, with a set of beautifully designed alloy wheels.

CHOOSE YOUR INTERIOR

Page 66

There's a wide selection of premium materials, leathers, veneers and finishes for every personal taste.

CHOOSE YOUR JAGUAR GEAR

Page 80

Really make it yours by adding style, practicality and versatility with official XJ Gear Accessories from your local Jaguar Retailer.



1 CHOOSE YOUR ENGINE

Configure your vehicle at JAGUARUSA.COM

> V6 ENGINES

3.0 LITER V6 SUPERCHARGED GAS

MAXIMUM POWER 340HP
MAXIMUM TORQUE 332 lb-ft
ACCELERATION 0-60 mph 5.7 seconds**
TOP SPEED 121 mph**
XJ R-SPORT, XJL PORTFOLIO

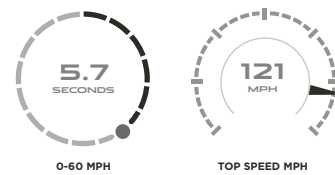

3.0 LITER V6 SUPERCHARGED GAS AWD

MAXIMUM POWER 340HP
MAXIMUM TORQUE 332 lb-ft
ACCELERATION 0-60 mph 6.1 seconds**
TOP SPEED 121 mph**
XJ R-SPORT, XJL PORTFOLIO

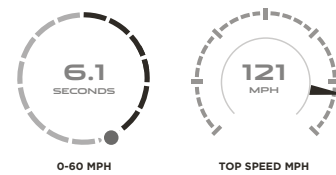

> V8 ENGINES

5.0 LITER V8 SUPERCHARGED GAS

MAXIMUM POWER 470HP
MAXIMUM TORQUE 424 lb-ft
ACCELERATION 0-60 mph 4.9 seconds**
TOP SPEED 155 mph**
XJ SUPERCHARGED, XJL SUPERCHARGED

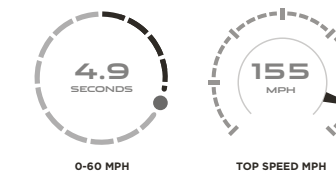

5.0 LITER V8 SUPERCHARGED GAS

MAXIMUM POWER 575HP
MAXIMUM TORQUE 517 lb-ft
ACCELERATION 0-60 mph 4.2 seconds**
TOP SPEED 186 mph**
XJR575 LWB

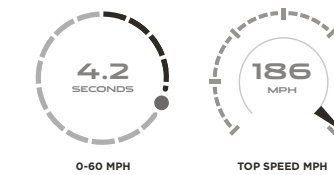

**Please see page 90 for further information.



2 CHOOSE YOUR MODEL & PACKAGES

⚙️ Configure your vehicle at JAGUARUSA.COM

➤ STANDARD WHEELBASE



XJ R-SPORT

KEY FEATURES

- 19" alloy wheels
- 'R-Sport' exterior with black mesh grill, side sills and rear spoiler
- Full LED Headlights with Adaptive Lighting and Automatic High Beam Assist*⁵
- Panoramic Glass Roof - Tilt/Slide Front Section with Electric Blind
- 8 way Power Front Seats with 4 way Lumbar Adjustment
- Soft grain leather active-ventilated heated and cooled front and rear seats
- 10" Touchscreen Touch Pro™ with connected Navigation*¹
- 12.3" Interactive Driver Display
- Meridian Digital Surround Sound System (825W)
- Blind Spot Monitor and Reverse Traffic Detection*⁵
- Front and Rear Parking Aids*⁵
- All Surface Progress Control*⁵
- Twin Oval Exhausts



XJ SUPERCHARGED

KEY FEATURES (IN ADDITION TO 'XJ R-SPORT')

- 20" alloy wheels
- Four-Zone Climate Control
- Active Differential Control
- Re-tuned Suspension
- 14 way Power Front Seats with 4 way Lumbar Adjustment
- Front Seats with Five Massage Programs
- Passenger Seat Memory
- Electric Rear Window Sunblind

➤ LONG WHEELBASE



XJL PORTFOLIO

KEY FEATURES

- 19" alloy wheels
- Full LED Headlamps with Adaptive Lighting and Automatic High Beam Assist*⁵
- Panoramic Glass Roof - Tilt/Slide Front Section with Electric Blind
- 14 way Power Front Seats with 4 way Lumbar Adjustment
- Front Seats with Five Massage Programs
- Soft grain leather active-ventilated heated and cooled front and rear seats
- 10" Touchscreen*²
- Touch Pro™ with connected Navigation*¹
- 12.3" Interactive Driver Display
- Meridian Digital Surround Sound System (825W)
- Blind Spot Monitor and Reverse Traffic Detection*⁵
- Four-Zone Climate Control
- Front and Rear Parking Aid*⁵
- All Surface Progress Control*⁵
- Twin Oval Exhausts



XJL SUPERCHARGED

KEY FEATURES (IN ADDITION TO 'XJL PORTFOLIO')

- 20" alloy wheels
- Active Differential Control
- Re-tuned Suspension



XJR575

KEY FEATURES (IN ADDITION TO 'XJL SUPERCHARGED')

- XJR575 Treadplates
- Gloss Black Grille with Gloss Black Surround
- Gloss Black side window surround
- Gloss Black side power vents
- Red painted brake calipers with Jaguar Script
- XJR575 Hood Louvers
- Body-colored Rear Valance with Gloss Black insert
- Unique Sports Exhaust with Quad pipes
- Aluminium Paddle Shifters
- Illuminated Air Vents
- Sport Seats with "575" Badging
- Carbon Fiber Engine Cover
- Carbon Fiber Veneer
- 360° Parking Aid*⁵
- Park Assist*⁵

*Please see page 90 for further information.



2 CHOOSE YOUR MODEL & PACKAGES

Configure your vehicle at JAGUARUSA.COM

KEY STANDARD & OPTIONAL FEATURES

TRANSMISSION, STEERING & DYNAMIC FEATURES

	XJ R-SPORT	XJ SUPERCHARGED	XJL PORTFOLIO	XJL SUPERCHARGED	XJR575
8-Speed ZF electronic automatic transmission with Jaguar Sequential Shift™ with Drive and Sport Modes*5	●	●	●	●	●
Steering wheel mounted shift paddles	●	●	●	●	●
JaguarDrive Control™ - with Normal, Winter & Dynamic Modes*5	●	●	●	●	●
JaguarDrive Selector™ rotary gear selector	●	●	●	●	●

STEERING

Power-assisted, speed sensitive, variable ratio, rack and pinion steering	●	●	●	●	●
Electric Power Steering (EPAS)*5	●	●	●	●	●
Hydraulic Power steering (AWD models only)	●	—	●	—	—

SUSPENSION

Adaptive Dynamics*5	●	●	●	●	●
Active Differential Control*5	—	●	—	●	●
Suspension - front coils, rear air (self-leveling) - Standard	●	—	●	—	—
Suspension - front coils, rear air (self-leveling) - Supercharged	—	●	—	●	—
Suspension - front coils, rear air (self-leveling) - 'R' tuned	—	—	—	—	●
All Surface Progress Control (ASPC)*5	●	●	●	●	●

BRAKES & STABILITY CONTROL

Anti-Lock Braking System (ABS)	●	●	●	●	●
Emergency Brake Assist (EBA)*5	●	●	●	●	●
Dynamic Stability Control (DSC) with Trac DSC mode*5	●	●	●	●	●
Electric Parking Brake (EPB) drive away release	●	●	●	●	●
Red brake callipers with 'JAGUAR' script	—	—	—	—	●

EXHAUST

Standard Exhaust	●	●	●	●	—
Sport Exhaust	—	—	—	—	●

● Standard ○ Optional — Not available

P2 Illumination Package P3 Premium Rear Seat Package See page 61 for page details.

*Please see page 90 for further information.

SAFETY & SECURITY

SAFETY

	XJ R-SPORT	XJ SUPERCHARGED	XJL PORTFOLIO	XJL SUPERCHARGED	XJR575
Active Head Restraints with front seat whiplash protection	●	●	●	●	●
Airbags: Dual-stage front airbags and side airbags for front occupants*5	●	●	●	●	●
Airbags: Side curtain airbags for front and rear*5	●	●	●	●	●
Belt minder system (front and rear)	●	●	●	●	●
Safety belt pretensioners for front seating positions	●	●	●	●	●
Lower Anchors and Tethers for Children (LATCH)	●	●	●	●	●
Child seat tethered-anchorage	●	●	●	●	●
Three-point seatbelts at all 5 seating positions	●	●	●	●	●
Tire Pressure Monitoring System (TPMS)	●	●	●	●	●
Trunk entrapment release	●	●	●	●	●

SECURITY

Security system - alarm and engine immobilizer	●	●	●	●	●
Remote control locking with driveaway locking	●	●	●	●	●

DRIVERS AIDS

	XJ R-SPORT	XJ SUPERCHARGED	XJL PORTFOLIO	XJL SUPERCHARGED	XJR575
Cruise control with Automatic Speed Limiter (ASL)*5	●	●	●	●	●
Adaptive Cruise Control (ACC) with Forward Alert and Intelligent Emergency Brake, Forward Alert and Queue Assist*5. Includes active seat belts	○	○	○	○	○
Blind Spot Assist and Reverse Traffic Detection (RWD models only)*5	●	●	●	●	●
Blind Spot Monitor and Reverse Traffic Detection (AWD models only)*5	●	—	●	—	—
Traffic Sign Recognition and Adaptive Speed Limiter*5	●	●	●	●	●
Front and Rear Parking Aid sensors with Touch-screen visual indicators*5	●	●	●	●	●
360° Parking Aid - additional sensors to alert the driver to potential side impacts	○	○	○	○	●
Rear View Camera parking aid with guidance lines on display*5	●	●	●	●	●
Surround Camera system*5	○	○	○	○	○
Park Assist - Parallel, Perpendicular and Exit*5 (RWD models only)	○	○	○	○	●
Lane Departure Warning and Lane Keep Assist*5 (RWD models only)	●	●	●	●	●
Driver Condition Monitor*5 (RWD models only)	●	●	●	●	●

CONVENIENCE FEATURES

	XJ R-SPORT	XJ SUPERCHARGED	XJL PORTFOLIO	XJL SUPERCHARGED	XJR575
Approach Illumination (automatic via remote)	●	●	●	●	●
Door puddle lamps (front and rear)	●	●	●	●	●
Rear Business Tables - The table center material is leather; with the outer edges finished with soft feel paint. The back panel is all leather	—	—	P3	P3	—
Front Ashtray and Lighter	NCO	NCO	NCO	NCO	NCO
Garage-door/entry-gate opener	●	●	●	●	●
Illuminated rear vanity mirrors	—	—	●	●	●
Jaguar Smart Key System™ with keyless entry and start	●	●	●	●	●
Rain-sensing, variable intermittent dual windshield wipers	●	●	●	●	●
Rear LED reading lamps	P2	P2	●	●	●
Soft door close	●	●	●	●	●
Sun Visors Driver and front passenger w/illuminated vanity mirrors	●	●	●	●	●



2 CHOOSE YOUR MODEL & PACKAGES

Configure your vehicle at JAGUARUSA.COM

EXTERIOR FEATURES		XJ R-SPORT	XJ SUPERCHARGED	XJL PORTFOLIO	XJL SUPERCHARGED	XJR575
BODY EXTERIOR APPEARANCE						
Front Grille	Chrome mesh with Chrome surround	—	—	●	●	—
	Black mesh with Chrome surround	●	●	—	—	—
	Black mesh with Gloss Black surround	—	—	—	—	●
Front Bumper	Sculpted with Gloss Black finish	—	—	—	—	●
Blades - front lower grilles - Chrome		●	●	●	●	—
3-piece lower front splitter	Body colored all sections	—	—	—	—	—
	Body colored outer, back center section	●	●	—	—	●
Window Surround Finishers	Gloss Black	—	—	—	—	●
	Chrome	●	●	●	●	—
Hood louvers		—	—	—	—	●
Extended side sills		●	●	—	—	●
Rear trunklid spoiler		●	●	—	—	●
Tailpipes	Twin oval with Chrome finisher	●	●	●	●	—
	Quad with Chrome finisher	—	—	—	—	●
Rear Valance	Gloss Black	●	●	—	—	—
	Gloss Black with Chrome blade	—	—	●	●	—
	Body colored with Black panel insert	—	—	—	—	●

EXTERIOR FEATURES		XJ R-SPORT	XJ SUPERCHARGED	XJL PORTFOLIO	XJL SUPERCHARGED	XJR575
EXTERIOR BADGING						
Front grille - 'R'	Chrome with no script	—	—	—	—	●
	Chrome with Supercharged script	—	●	—	●	—
	Chrome side with Black mesh - 'R-Sport' script Gloss Black with Black mesh	●	—	—	—	—
Side power vents		●	—	—	—	—
Center trunk lid - Jaguar leaper and Jaguar script	Gloss Black side with Black mesh	—	—	—	—	●
	'AWD' w/AWD models only	●	—	●	—	—
	Powertrain - '3.0'	●	—	●	—	—
	Powertrain - '5.0'	—	●	—	●	—
Trunk right side	'575R'	—	—	—	—	●
	Nameplate 'XJ' or 'XJL' as appropriate	●	●	●	●	●
Nameplate debadging - Removes 'XJ' and displacement badge	○	○	○	○	—	—
GLASS						
Rear window - heated with timer		●	●	●	●	●
Solar Attenuating glass		●	●	●	●	●
Acoustically laminated glass (windshield and front door glass)		●	●	●	●	●
Panoramic Glass Roof - Tilt/Slide Front Section with Electric Blind		●	●	●	●	●
Heated front windshield with timer		○	○	○	○	○
LAMPS						
Full LED headlights w/washers, auto-leveling, auto on/off, LED signature		●	●	●	●	●
Adaptive Front Lighting and Auto High Beam Assist Light Emitting Diode (LED) tail lights		●	●	●	●	●

● Standard ○ Optional — Not available
 P1 Comfort Package P2 Illumination Package P3 Premium Rear Seat Package See page 61 for package details.
 *Please see page 90 for further information.

CONTENTS

PERSONALIZATION

LOCATE A RETAILER

BUILD YOURS

INTERIOR FEATURES

	XJ R-SPORT	XJ SUPERCHARGED	XJL PORTFOLIO	XJL SUPERCHARGED	XJR575
Jaguar premium analog dash clock	●	●	●	●	●
Intaglio - Gloss Black with 'JAGUAR' script	●	●	●	●	—
Intaglio - Gloss Black with '575' script	—	—	—	—	●
White and Phosphor Blue halo illumination and Interior lighting	●	●	●	●	●
JaguarSense™ overhead light operation and glove box opening	●	●	●	●	●
Illuminated air vents front and rear	P2	P2	P2	P2	●
Metallic foot pedals	—	—	—	—	●
Carbon Fiber Engine Cover	—	—	—	—	●

CLIMATE CONTROL

Dual zone automatic climate control with air filtration, humidity sensing and dual zone temperature control for driver and front passenger	●	—	—	—	—
Four zone automatic climate control with air filtration, humidity sensing and four zone temperature control for driver, front passenger and independent control for left and right rear passengers	P1	●	●	●	●
Air quality sensor with Auto recirculation	●	●	●	●	●

MIRRORS & WINDOWS

Auto-dimming interior rear view mirror	●	●	●	●	●
Exterior mirrors - electric adjustment, heated, auto-dimming, power-folding with courtesy puddle lamps and memory function	●	●	●	●	●
Front and rear electric windows with one-touch open/close and anti-trap	●	●	●	●	●

WINDOW SUNBLINDS

Electrically operated rear window sunblind	P1	●	●	●	●
Electric rear side window sunblinds	—	—	●	●	●

FOOTWELLS

Premium front and rear floor mats - edged in interior contrast color	●	●	●	●	●
Stainless steel sill tread plates - Jaguar script	●	●	●	●	—
Stainless steel sill tread plates - XJR575 script (Except when illumination fitted)	—	—	—	—	●
Stainless steel sill tread plates - Jaguar script, illuminated	P2	P2	P2	P2	P2
Courtesy Footwell Lights - front and rear	●	●	●	●	●

STEERING WHEEL & CONTROLS

Steering column with electric adjustment for height reach with entry and exit tilt	●	●	●	●	●
Heated leather steering wheel: 3-spoke soft grain leather heated with Jaguar Sequential Shift™ paddles and remote controls for audio system, cruise control, Bluetooth® telephone connectivity	●	●	●	●	—
Heated leather steering wheel: 3-spoke soft grain leather heated with 'R' logo to the bottom spoke with Jaguar Sequential Shift™ paddles and remote controls for audio system, cruise control, Bluetooth® telephone connectivity	—	—	—	—	●
Leather and wood steering wheel: 3-spoke wood and leather heated steering wheel with Jaguar Sequential Shift™ paddles and remote controls for audio system, cruise control, Bluetooth® telephone connectivity	○	○	○	○	—
Three-flash lane change indicators	●	●	●	●	●

SEATING

8x8 way power front seats (forward/rear, cushion height, back seat recline and cushion tilt - plus manual headrest)	●	—	—	—	—
14x14 way power front seats (forward/rear, cushion height, back seat recline, cushion tilt, powered headrest and 2 ways adjustable bolsters)	P1	●	●	●	—
14x14 way power front Sport seats - Quilted soft grain leather with embossed '575' script	—	—	—	—	●
4 way lumbar - Driver and Passenger	●	●	●	●	●
Massage - includes 5 massage modes and 5 levels of intensity	P1	●	●	●	—
Heated and cooled active ventilated front seats	●	●	●	●	●
Rear seat, two individual seats with back movement and rear seat back upper articulation including Massage with 3 modes	—	—	P3	P3	—
Headrest - Embossed Leaper	●	●	●	●	—
Seat back rest front and rear - Embossed '575' script	—	—	—	—	●
Winged headrests - front and rear (Removes Embossed Leaper)	—	—	P3	P3	—
Front passenger seat away (fore/aft) side seat switch for driver control	—	—	P3	P3	—
Full control of front passenger seat from rear passenger seat controls (passenger side only)	—	—	P3	P3	—
Remote control of all seat positions from Touch-screen	—	—	P3	P3	—
Rear seat footrests (drop in)	—	—	P3	P3	—
Memory function with 3 settings for driver seat, exterior mirrors and steering column	●	—	—	—	—
Memory function with 3 settings for driver and passenger seats, exterior mirrors and steering column	P1	●	●	●	●
Rear seat memory including showroom positioning for seat default positioning	—	—	P3	P3	—



2 CHOOSE YOUR MODEL & PACKAGES

Configure your vehicle at JAGUARUSA.COM

	XJ R-SPORT	XJ SUPERCHARGED	XJL PORTFOLIO	XJL SUPERCHARGED	XJR575
INTERIOR FEATURES CONTINUED					
INTERIOR TRIM					
Soft grain perforated leather seats front and rear with contrast stitch and piping and Leaper embossed in headrests	●	●	—	—	—
Quilted soft grain perforated leather seats front and rear with contrast stitch and Leaper embossed in headrests	—	—	●	●	—
Quilted soft grain perforated leather seats front and rear with contrast stitch and embossed '575' seat back. (No leaper in headrest)	—	—	—	—	●
Soft feel stitched and tailored upper fascia, door top roll and armrest and center console lid with twin needle stitching	●	●	—	—	—
Soft grain leather stitched and tailored upper fascia, door top roll, door pannier, door armrest and center console lid with twin needle stitching	—	—	●	●	—
Soft grain leather stitched and tailored upper fascia, IP binnacle, door top roll, door pannier, door armrest and center console lid with twin needle stitching	—	—	—	—	●
Morzine Headlining	●	●	—	—	—
Jaguar Suedecloth Premium Headlining	—	—	●	●	●
STORAGE					
Front center console with illuminated storage compartment, auxiliary power socket and armrest	●	●	●	●	●
Twin front cupholders (32oz) with sliding cover	●	●	●	●	●
Rear Center Armrest w/twin cupholders (20oz)	●	●	●	●	●
Rear Center Armrest with rear seat control switch panel and RSE remote storage	—	—	P3	P3	—
Rear Coat Hooks	●	●	●	●	●
TRUNK					
Power trunk lid with adjustable opening height	●	●	●	●	●
Trunk latch finishing plate	●	●	●	●	●
Trunk latch finishing plate, illuminated	P2	P2	P2	P2	P2
VENEER TRIM					
Gloss Burl Walnut	●	○	●	○	—
Gloss Figured Ebony	○	—	○	—	—
Gloss Rich Oak	—	●	—	●	—
Piano Black	○	○	○	○	○
Carbon Fiber	○	○	○	○	●

INFORMATION, COMMUNICATION & ENTERTAINMENT

	XJ R-SPORT	XJ SUPERCHARGED	XJL PORTFOLIO	XJL SUPERCHARGED	XJR575
MULTIMEDIA					
Virtual Instruments - 12.3" Interactive Driver Display	●	●	●	●	●
Touch Pro™ - 10" Touch-screen - controls audio, Navigation, Bluetooth*, climate control. Solid State Drive-based Navigation*1	●	●	●	●	●
InControl Apps™ Enables use of optimized 3rd party smartphone apps installed on a phone through the vehicle's touch screen*1	●	●	●	●	●
Meridian™ 825W 7.1 Channel Digital Surround Sound System plus Meridian™ Trifield mode, 20 speakers including 2 subwoofers, separate DSP, Audyssey MultEQ and Meridian™ Cabin Correction	●	●	●	●	●
Meridian™ 1,300W Reference system 7.1 surround sound system	○	○	○	○	—
HD Radio™	●	●	●	●	●
SiriusXM® Satellite Radio (3 mo. Complimentary subscription included)*4	●	●	●	●	●
Auxiliary power points in rear (x2)	●	●	●	●	●
Rear Seat Entertainment w/dual 10.2-inch LCD screens that folds into the rear of the front seats. Includes Rear Multimedia Interface, Touch-screen remote control and 2 wireless headphones	—	—	P3	P3	—
NAVIGATION					
Touch Pro™ Navigation*1	●	●	●	●	●
Bluetooth® v2.0 wireless technology for cell phone and audio streaming*2	●	●	●	●	●
TELEMATICS					
Protect™ - SOS emergency call, Jaguar Assistance Call and Stolen vehicle locator. Service complimentary for 5 years	●	●	●	●	●
Remote™ - Smart phone application for vehicle status (fuel level, security status, last parked, direction to vehicle), vehicle lock/unlock, A/C remote setting through engine start. Feature complimentary for 5 years	●	●	●	●	●
Wi-Fi - 4G hotspot - includes 4GB or 3 months (whichever comes first) complimentary data subscription*3	●	●	●	●	●

OPTIONS PACKAGES

	CODE	XJ R-SPORT	XJ SUPERCHARGED	XJL PORTFOLIO	XJL SUPERCHARGED	XJR575	DESCRIPTION
Comfort Package (P1)	Z03P	○	—	—	—	—	14x14 way adjustable front seats, Front Seats massage with 5 modes, each with 5 intensity settings, Passenger memory Seats, 4 Zone Air Conditioning, Electric rear sunblind
Illumination Package (P2)	Z46B	○	○	○	○	○	Illuminated Stainless Steel sill tread plates - Jaguar script, Illuminated air vents front and rear, Illuminated trunk latch finishing plate, LED Rear reading lights (SWB models)
Premium Rear Seat Package (P3)	Z30B	—	—	○	○	—	Two individual rear seats with back movement and upper articulation including Massage with 3 intensity setting, Folding rear center armrest with rear seat switch panels, Electric Side window sunblinds, Winged Headrests (Removes Embossed Leaper), Rear seat memory, Rear business tables, Remote control of all seats positions from Touchscreen, Rear Seat Entertainment - Dual 10.2" LCD screens, Touchscreen remote control and wireless digital headphones (x2)

STAND ALONE OPTIONS

	CODE	XJ R-SPORT	XJ SUPERCHARGED	XJL PORTFOLIO	XJL SUPERCHARGED	XJR575	DESCRIPTION
Adaptive Cruise Control with Forward Alert, Emergency Brake Assist and Queue Assist*5	H41F	○	○	○	○	○	—
Meridian™ 1300W Reference Sound System with Conversation Assist	B43X	○	○	○	○	—	Refer to page 44
Wood and Leather Heated Steering wheel	F95W	○	○	○	○	—	—
Heated Front Windshield with timer	D96A	○	○	○	○	○	—
Front Ashtray and Lighter	A03B	NCO	NCO	NCO	NCO	NCO	—
Nameplate debadging	B75Z	NCO	NCO	NCO	NCO	—	Removes "XJ/XJL" and displacement badge
Ebony Suedecloth headliner	HPFD	—	—	○	○	●	—
Surround Camera system*5	C14C	○	○	○	○	○	—

● Standard ○ Optional — Not available NCO No Cost Option
P1 Comfort Package P2 Illumination Package P3 Premium Rear Seat Package
*Please see page 90 for further information.



CONTENTS

PERSONALIZATION

LOCATE A RETAILER

BUILD YOURS

3 CHOOSE YOUR COLOR

Configure your vehicle at JAGUARUSA.COM

SOLID

Fuji White

Narvik Black

METALLIC

Yulong White

Indus Silver

Corris Grey

Loire Blue

Rosello Red

Firenze Red

British Racing Green

Santorini Black

PREMIUM METALLIC

Carpathian Grey

Farallon Black

SVO PREMIUM PALETTE

Velocity Blue

Satin Corris Grey



ENGINE

MODEL & PACKAGES

COLOR

WHEELS

INTERIOR

JAGUAR GEAR

TECHNICAL SPECIFICATIONS

SPECIAL VEHICLE OPERATIONS



4 CHOOSE YOUR WHEELS

Configure your vehicle at JAGUARUSA.COM



19" 10 SPOKE 'STYLE 1028'

Sparkle Finish
9.0J x 19" / 10.0J x 19"
245/45ZR19 / 275/40ZR19
C45C



19" 5 SPLIT-SPOKE 'STYLE 5043'

Sparkle Finish
9.0J x 19" / 10.0J x 19"
245/45ZR19 / 275/40ZR19
C45D



19" 7 SPLIT-SPOKE 'STYLE 7016'

Sparkle Finish
9.0J x 19" / 10.0J x 19"
245/45ZR19 / 275/40ZR19
C52F

ALLOY WHEEL FINISH	19" 10 SPOKE 'STYLE 1028'	19" 5 SPLIT-SPOKE 'STYLE 5043'	19" 7 SPLIT-SPOKE 'STYLE 7016'
ALLOY WHEEL / SIZE	9.0J x 19" / 10.0J x 19"	9.0J x 19" / 10.0J x 19"	9.0J x 19" / 10.0J x 19"
TIRE SIZE	245/45ZR19 / 275/40ZR19	245/45ZR19 / 275/40ZR19	245/45ZR19 / 275/40ZR19
CODE	C45C	C45D	C52F
XJ R-Sport	●	○	○
XJ Supercharged	—	—	—
XJL Portfolio	—	●	○
XJL Supercharged	—	—	○
XJR575	—	—	—



20" 5 SPLIT-SPOKE 'STYLE 5045'

Silver and Diamond Turned Finish
9.0J x 20" / 10.0J x 20"
245/40ZR20 / 275/35ZR20
C46A



20" 10 SPLIT-SPOKE 'STYLE 1029'

High Gloss Silver
9.0J x 20" / 10.0J x 20"
245/40ZR20 / 275/35ZR20
C45G

ALLOY WHEEL FINISH	20" 5 SPLIT-SPOKE 'STYLE 5045'	20" 10 SPLIT-SPOKE 'STYLE 1029'
ALLOY WHEEL / SIZE	9.0J x 20" / 10.0J x 20"	9.0J x 20" / 10.0J x 20"
TIRE SIZE	245/40ZR20 / 275/35ZR20	245/40ZR20 / 275/35ZR20
CODE	C46A	C45G
XJ R-Sport	○	—
XJ Supercharged	—	—
XJL Portfolio	—	—
XJL Supercharged	—	●
XJR575	—	—



20" 8 SPLIT-SPOKE 'STYLE 8001'

Silver
9.0J x 20" / 10.0J x 20"
245/40ZR20 / 275/35ZR20
C45J



20" 8 SPLIT-SPOKE 'STYLE 8001'

Polished
9.0J x 20" / 10.0J x 20"
245/40ZR20 / 275/35ZR20
C45K



20" 5 SPLIT-SPOKE 'STYLE 5063'

Satin Grey
9.0J x 20" / 10.0J x 20"
245/40ZR20 / 275/35ZR20
C66E

ALLOY WHEEL FINISH	20" 8 SPLIT-SPOKE 'STYLE 8001'	20" 8 SPLIT-SPOKE 'STYLE 8001'	20" 5 SPLIT-SPOKE 'STYLE 5063'
ALLOY WHEEL / SIZE	9.0J x 20" / 10.0J x 20"	9.0J x 20" / 10.0J x 20"	9.0J x 20" / 10.0J x 20"
TIRE SIZE	245/40ZR20 / 275/35ZR20	245/40ZR20 / 275/35ZR20	245/40ZR20 / 275/35ZR20
CODE	C45J	C45K	C66E
XJ R-Sport	○	○	—
XJ Supercharged	○	○	●
XJL Portfolio	○	○	—
XJL Supercharged	○	○	—
XJR575	—	—	—



20" 5 SPLIT-SPOKE 'STYLE 5044'

Technical Grey
9.0J x 20" / 10.0J x 20"
265/35R20 / 295/30R20
C51Y



20" 5 SPLIT-SPOKE 'STYLE 5044'

Gloss Black
9.0J x 20" / 10.0J x 20"
265/35R20 / 295/30R20
C52H

ALLOY WHEEL FINISH	20" 5 SPLIT-SPOKE 'STYLE 5044'	20" 5 SPLIT-SPOKE 'STYLE 5044'
ALLOY WHEEL / SIZE	9.0J x 20" / 10.0J x 20"	9.0J x 20" / 10.0J x 20"
TIRE SIZE	265/35R20 / 295/30R20	265/35R20 / 295/30R20
CODE	C51Y	C52H
XJ R-Sport	—	—
XJ Supercharged	—	—
XJL Portfolio	—	—
XJL Supercharged	—	—
XJR575	○	●

● Standard ○ Option — Not Applicable
Standard and optional features may differ depending on market availability. Please consult your local Jaguar Retailer for details.



5 CHOOSE YOUR INTERIOR

Configure your vehicle at JAGUARUSA.COM

STANDARD WHEELBASE

XJ R-SPORT							
	SEAT SOFT GRAIN PERFORATED LEATHER WITH STITCH/PIPING	VENEER*	MORZINE HEADLINING	UPPER FASCIA SOFT FEEL	LOWER FASCIA	CARPET	INTERIOR TRIM CODES
	Ivory/Mineral/Mineral	Gloss Burl Walnut	Ivory	Mineral	Ivory	Mineral	BAPP
	Cashew/Truffle/Truffle	Gloss Burl Walnut	Ivory	Truffle	Cashew	Truffle	BAOQ
	London Tan/Ebony/Ebony	Gloss Burl Walnut	Ivory	Ebony	Ebony	Ebony	BAOS
	Ebony/Ivory/Ivory	Gloss Burl Walnut	Ivory	Ebony	Ebony	Ebony	BAOP

XJ SUPERCHARGED							
	SEAT SOFT GRAIN PERFORATED LEATHER WITH STITCH/PIPING	VENEER*	MORZINE HEADLINING	UPPER FASCIA SOFT FEEL	LOWER FASCIA	CARPET	INTERIOR TRIM CODES
	Ivory/Mineral/Mineral	Gloss Rich Oak	Ivory	Mineral	Ivory	Mineral	BAPP
	Cashew/Truffle/Truffle	Gloss Rich Oak	Ivory	Truffle	Cashew	Truffle	BAOQ
	London Tan/Ebony/Ebony	Gloss Rich Oak	Ivory	Ebony	Ebony	Ebony	BAOS
	Ebony/Ivory/Ivory	Gloss Rich Oak	Ivory	Ebony	Ebony	Ebony	BAOP

LONG WHEELBASE

XJL PORTFOLIO							
	SEAT SOFT GRAIN QUILTED AND PERFORATED LEATHER WITH STITCH	VENEER*	PREMIUM SUEDECLOTH HEADLINING	UPPER FASCIA SOFT GRAIN LEATHER	LOWER FASCIA	CARPET	INTERIOR TRIM CODES
	Ebony/Ivory	Gloss Burl Walnut	Ivory or Ebony	Ebony	Ebony	Ebony	BAOT
	London Tan/Ebony	Gloss Burl Walnut	Ivory or Ebony	Ebony	London Tan	Ebony	BAOZ
	Cashew/Truffle	Gloss Burl Walnut	Ivory	Truffle	Cashew	Truffle	BAOU
	Ivory/Mineral	Gloss Burl Walnut	Ivory	Mineral	Ivory	Mineral	BAPQ
	Ivory/Ebony	Gloss Burl Walnut	Ivory or Ebony	Ebony	Ivory	Ebony	BAOV

XJL SUPERCHARGED							
	SEAT SOFT GRAIN QUILTED AND PERFORATED LEATHER WITH STITCH	VENEER*	PREMIUM SUEDECLOTH HEADLINING	UPPER FASCIA SOFT GRAIN LEATHER	LOWER FASCIA	CARPET	INTERIOR TRIM CODES
	Ebony/Ivory	Gloss Rich Oak	Ivory or Ebony	Ebony	Ebony	Ebony	BAOT
	London Tan/Ebony	Gloss Rich Oak	Ivory or Ebony	Ebony	London Tan	Ebony	BAOZ
	Cashew/Truffle	Gloss Rich Oak	Ivory	Truffle	Cashew	Truffle	BAOU
	Ivory/Mineral	Gloss Rich Oak	Ivory	Mineral	Ivory	Mineral	BAPQ
	Ivory/Ebony	Gloss Rich Oak	Ivory or Ebony	Ebony	Ivory	Ebony	BAOV

XJR575							
	SEAT SOFT GRAIN PERFORATED LEATHER WITH STITCH	VENEER*	PREMIUM SUEDECLOTH HEADLINING	UPPER FASCIA SOFT GRAIN LEATHER	LOWER FASCIA	CARPET	INTERIOR TRIM CODES
	Ebony/Pimento	Carbon Fiber	Ebony	Ebony	Ebony	Ebony	BAMQ
	Ivory/Ebony	Carbon Fiber	Ebony	Ebony	Ivory	Ebony	BAMS

*Optional veneers are available. Please consult your local Jaguar Retailer for details.

5 CHOOSE YOUR INTERIOR

























Configure your vehicle at JAGUARUSA.COM

Interior shown: Cashew soft grain perforated leather seats with Truffle upper fascia, Ivory morzine headlining, Gloss Figured Ebony veneer and Truffle carpet.



XJ R-SPORT

INTERIOR COLOR COMBINATIONS

1	2	3	4	5	6
SEAT WITH CONTRAST STITCH AND PIPING	VENEER	MORZINE HEADLINING	UPPER FASCIA	LOWER FASCIA	CARPET
 Ivory with Mineral stitch	 Gloss Burl Walnut	 Ivory	 Mineral	 Ivory	 Mineral
 Cashew with Truffle stitch	 Gloss Burl Walnut	 Ivory	 Truffle	 Cashew	 Truffle
 London Tan with Ebony stitch	 Gloss Burl Walnut	 Ivory	 Ebony	 Ebony	 Ebony
 Ebony with Ivory stitch	 Gloss Burl Walnut	 Ivory	 Ebony	 Ebony	 Ebony

VENEER OPTIONS

Carbon Fiber, Piano Black or Gloss Figured Ebony

























5 CHOOSE YOUR INTERIOR

Configure your vehicle at JAGUARUSA.COM

Interior shown: Ivory soft grain perforated leather seats with Mineral upper fascia, Ivory morzine headlining, Gloss Rich Oak veneer and Mineral carpet.



XJ SUPERCHARGED INTERIOR COLOR COMBINATIONS

1	2	3	4	5	6
SEAT WITH CONTRAST STITCH AND PIPING	VENEER	MORZINE HEADLINING	UPPER FASCIA	LOWER FASCIA	CARPET
 Ivory with Mineral stitch	 Gloss Rich Oak	 Ivory	 Mineral	 Ivory	 Mineral
 Cashew with Truffle stitch	 Gloss Rich Oak	 Ivory	 Truffle	 Cashew	 Truffle
 London Tan with Ebony stitch	 Gloss Rich Oak	 Ivory	 Ebony	 Ebony	 Ebony
 Ebony with Ivory stitch	 Gloss Rich Oak	 Ivory	 Ebony	 Ebony	 Ebony

VENEER OPTIONS

Carbon Fiber, Piano Black or Gloss Burl Walnut

5 CHOOSE YOUR INTERIOR

Configure your vehicle at JAGUARUSA.COM

Interior shown: Ivory quilted soft grain perforated leather seats with Ebony contrast stitch, Ebony upper fascia, Ivory Suedecloth headlining, Gloss Burl Walnut veneer and Ebony carpet.

Image shown includes Rear Seat Entertainment.



XJL PORTFOLIO INTERIOR COLOR COMBINATIONS

1	2	3	4	5	6
SEAT WITH CONTRAST STITCH	VENEER	SUEDECLOTH HEADLINING	UPPER FASCIA	LOWER FASCIA	CARPET
Ebony with Ivory stitch	Gloss Burl Walnut	Ivory or Ebony	Ebony	Ebony	Ebony
London Tan with Ebony stitch	Gloss Burl Walnut	Ivory or Ebony	Ebony	London Tan	Ebony
Cashew with Truffle stitch	Gloss Burl Walnut	Ivory	Truffle	Cashew	Truffle
Ivory with Mineral stitch	Gloss Burl Walnut	Ivory	Mineral	Ivory	Mineral
Ivory with Ebony stitch	Gloss Burl Walnut	Ivory or Ebony	Ebony	Ivory	Ebony

VENEER OPTIONS

Carbon Fiber, Piano Black or Gloss Figured Ebony



5 CHOOSE YOUR INTERIOR

Configure your vehicle at JAGUARUSA.COM

Interior shown: Ebony quilted soft grain perforated leather seats with Ivory contrast stitch, Ebony upper fascia, Ivory Suedecloth headlining, Gloss Rich Oak veneer and Ebony carpet. Image shown includes Rear Seat Entertainment.



XJL SUPERCHARGED INTERIOR COLOR COMBINATIONS

1	2	3	4	5	6
SEAT WITH CONTRAST STITCH	VENEER	SUEDECLOTH HEADLINING	UPPER FASCIA	LOWER FASCIA	CARPET
Jet with Ivory stitch	Gloss Rich Oak	Ivory or Jet	Jet	Jet	Jet
London Tan with Jet stitch	Gloss Rich Oak	Ivory or Jet	Jet	London Tan	Jet
Cashew with Truffle stitch	Gloss Rich Oak	Ivory	Truffle	Cashew	Truffle
Ivory with Mineral stitch	Gloss Rich Oak	Ivory	Oyster	Ivory	Mineral
Ivory with Jet stitch	Gloss Rich Oak	Ivory or Jet	Jet	Ivory	Jet

VENEER OPTIONS

Carbon Fiber, Piano Black or Gloss Burl Walnut



5 CHOOSE YOUR INTERIOR

Configure your vehicle at JAGUARUSA.COM

Interior shown: Ebony soft grain perforated quilted leather sports seats with Pimento contrast stitch, Ebony upper fascia, Ebony suedecloth headlining, Carbon Fiber veneer and Ebony carpet.



XJR575

INTERIOR COLOR COMBINATIONS

1	2	3	4	5	6
LEATHER SEAT WITH CONTRAST STITCH	VENEER	SUEDECLOTH HEADLINING	UPPER FASCIA	LOWER FASCIA	CARPET
Ebony with Pimento stitch	Carbon Fiber	Ebony	Ebony	Ebony	Ebony
Ivory with Ebony stitch	Carbon Fiber	Ebony	Ebony	Ivory	Ebony

VENEER OPTION

Piano Black



CONTENTS

PERSONALIZATION

LOCATE A RETAILER

BUILD YOURS

5 CHOOSE YOUR INTERIOR

Configure your vehicle at JAGUARUSA.COM

Piano Black

Carbon Fiber

Gloss Rich Oak

Gloss Figured Ebony

Gloss Burl Walnut

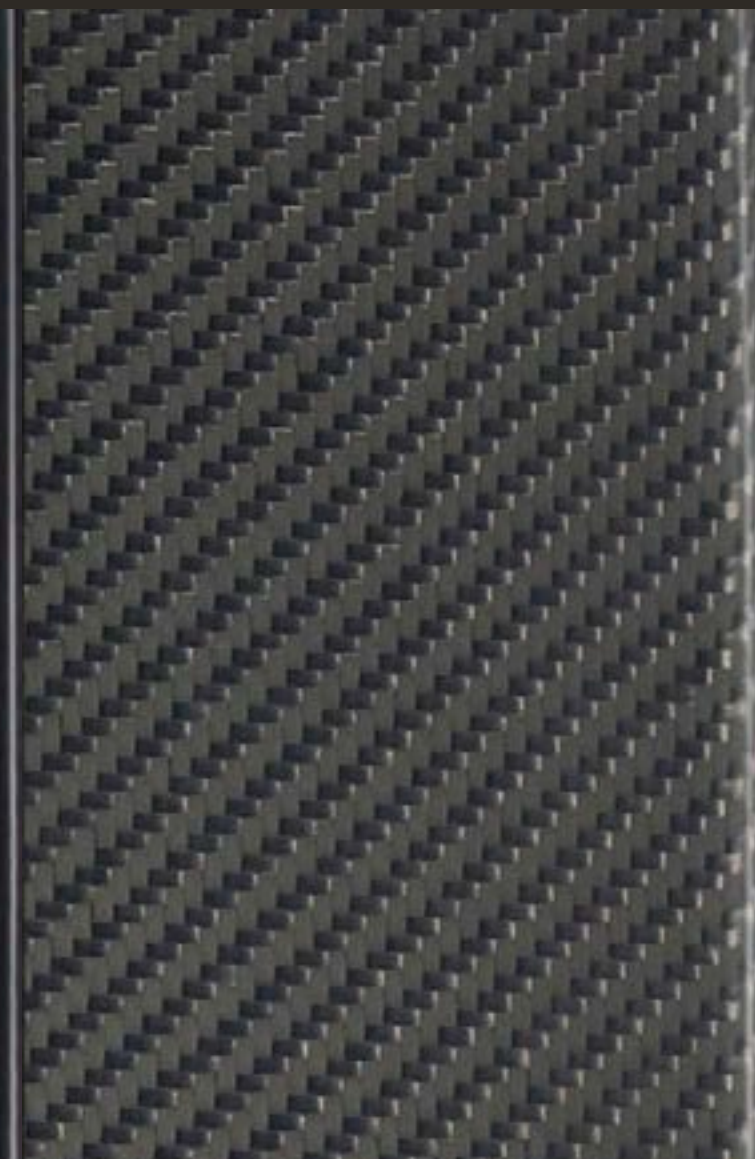

ENGINE

MODEL & PACKAGES

COLOR

WHEELS

INTERIOR

JAGUAR GEAR

TECHNICAL SPECIFICATIONS

SPECIAL VEHICLE OPERATIONS



6 CHOOSE YOUR JAGUAR GEAR

To find out more about the full range of Retailer fit Jaguar Gear accessories, please refer to your Retailer or go to JAGUARUSA.COM



Chrome Mirror Cover
C2D5489 - Left
C2D5488 - Right

Chrome mirror covers accentuate the stylish design of the exterior mirrors. Left and right side options available.

*Not compatible with rear seat entertainment.



Splash Guards
C2D8498 - Front
C2D8499 - Rear

Jaguar branded front splash guards complement the lines of your vehicle, reduce spray and help to provide protection from dirt and stone chippings.



Headrest Mounted Coat Hanger*
C2Z23416

The Jaguar coat hanger is a headrest mounted solution featuring Jaguar branding and a chromed 'spring fit' construction. Mounting simply and securely this coat hanger is easy to fit and remove and provides a convenient storage point to keep clothing wrinkle free.



Aluminum Gearshift Paddles
T2R6547MMU

Replacement steering wheel gearshift paddles, offered in a premium aluminum material, provide a high quality finish to a key contact point in the vehicle. Manufactured from billet machined aluminum, the paddles are hand brushed for a premium finish and anodized to ensure they will not deteriorate with wear.



Illuminated Treadplate

Elegantly styled aluminum sill treadplates illuminate when the driver or passenger doors are opened. Highlighted by soft Phosphor Blue lighting. Please consult your authorized Jaguar Retailer for ordering information.



iPad Holder*
C2Z22935

Jaguar branded iPad® holder mounts to front seat headrests providing a flexible solution for rear seat entertainment. Quick release design ensures iPad® can be fitted or removed quickly and easily.



Premium Loadspace Mat
C2D7450

Luxurious soft luggage mat in Ebony Black with the Jaguar logo. Deep premium 2,050g/m² pile with Nubuck edging and Dove contrast stitch.



TECHNICAL SPECIFICATIONS

Configure your vehicle at JAGUARUSA.COM

ENGINES		3.0 LITER V6 340 SUPERCHARGED GAS		5.0 LITER V8 470 SUPERCHARGED GAS	5.0 LITER V8 575 SUPERCHARGED GAS
Drive		RWD	AWD	RWD	RWD
Capacity	cc	2,995	2,995	5,000	5,000
Maximum power	hp	340	340	470	575
@rev/min		6,500	6,500	6,000-6,500	6,250-6,500
Maximum torque	lb-ft	332	332	424	517
@rev/min		3,500-5,000	3,500-5,000	2,000-5,500	3,500-4,500
Transmission		8-speed Automatic	8-speed Automatic	8-speed Automatic	8-speed Automatic
Tank capacity - SWB	US gallons	21.1	21.1	21.1	21.1
Tank capacity - LWB	US gallons	21.1	21.1	21.1	21.1
PERFORMANCE**					
0-60 mph	seconds	5.7	6.1	4.9	4.2
Top speed	mph	121	121	155	186
ENGINE AVAILABILITY					
XJ R-Sport		●	●	—	—
XJ Supercharged		—	—	●	—
XJL Portfolio		●	●	—	—
XJL Supercharged		—	—	●	—
XJR575		—	—	—	●

STANDARD WHEELBASE		3.0 LITER V6 340 SUPERCHARGED GAS		5.0 LITER V8 470 SUPERCHARGED GAS	5.0 LITER V8 575 SUPERCHARGED GAS
Drive		RWD	AWD	RWD	—
Overall length	in	202.0	202.0	202.0	—
Overall width (inc./exc. mirrors)	in	82.9/74.8	82.9/74.8	82.9/74.8	—
Overall height (inc. antenna)	in	57.5	57.5	57.5	—
Wheelbase	in	119.4	119.4	119.4	—
Front/Rear track	in	64/63.1	64/63.1	64/63.1	—
Turning circle diameter (curb-to-curb)	ft	39.0	40.7	39.0	—
Trunk volume with tire repair system	cu-ft	15.2	15.2	15.2	—
Front/Rear legroom	in	41.5/38.9	41.5/38.9	41.5/38.9	—
Headroom with sunroof (front)	in	39.5	39.5	39.5	—
Headroom (rear)	in	37.2	37.2	37.2	—
Front/Rear shoulder room	in	57.6/56.6	57.6/56.6	57.6/56.6	—
Weight**	lbs	3,891	4,112	4,134	—
Gross vehicle weight**	lbs	5,181	5,357	5,291	—
LONG WHEELBASE					
Drive		RWD	AWD	RWD	RWD
Overall length	in	206.9	206.9	206.9	206.9
Overall width (inc./exc. mirrors)	in	82.9/74.8	82.9/74.8	82.9/74.8	82.9/74.8
Overall height (inc. antenna)	in	57.5	57.5	57.5	57.5
Wheelbase	in	124.3	124.3	124.3	124.3
Front/Rear track	in	64/63.1	64/63.1	64/63.1	64/63.1
Turning circle diameter (curb-to-curb)	ft	40.4	42.3	40.4	40.4
Trunk volume with tire repair system	cu-ft	15.2	15.2	15.2	15.2
Front/Rear legroom	in	41.5/43.7	41.5/43.7	41.5/43.7	41.5/43.7
Headroom with sunroof (front)	in	39.5	39.5	39.5	39.5
Headroom (rear)	in	37.2	37.2	37.2	37.2
Front/Rear shoulder room	in	57.6/56.6	57.6/56.6	57.6/56.6	57.6/56.6
Weight**	lbs	3,913	4,134	4,156	4,156
Gross vehicle weight**	lbs	5,291	5,401	5,401	5,401

● Standard — Not available
 *Please see page 90 for further information.
 **Weights reflect vehicles to standard specifications. Optional extras increase weight.

DIMENSIONS

Overall Width (inc mirrors) 82.9 inches

Overall Width (exc mirrors) 74.8 inches

Trunk Volume 15.2 cu-ft



57.5 inches



Turning Circle (SWB)

Curb-to-curb RWD 39.0 ft
Curb-to-curb AWD 40.7 ft

Turning Circle (LWB)

Curb-to-curb RWD 40.4 ft
Curb-to-curb AWD 42.3 ft



VEHICLE SHOWN: XJ PORTFOLIO LONG WHEELBASE WITH OPTIONAL EQUIPMENT

Dimensions were measured with vehicle at unladen weight.
Trunk volume measured by VDA standard test method using 200 x 100 x 50mm blocks.



SPECIAL VEHICLE OPERATIONS

Special Vehicle Operations (SVO) designs and engineers products that amplify Jaguar and Land Rover core brand values; focusing on luxury, performance and capability.

Our team of specialists is completely focused on enhancing and personalizing our relationship with our most discerning and enthusiastic customers – delivering experiences that our customers will love for life.

SVO is responsible for the creation of a suite of halo products that showcase the pinnacle of Jaguar design and engineering capabilities, enabling our customers to indulge their passion for spectacular new vehicles.

THE NEW SVO TECHNICAL CENTER

In the heart of the British Midlands is SVO's brand new Technical Center. This state-of-the-art facility represents a \$25 million dollar investment by Jaguar Land Rover, and features four zones designed to support the creation of truly breath-taking vehicles. In addition to the Commissioning and Presentation suites, our manufacturing center is responsible for the assembly and hand-finishing of SVO halo and Collector's Edition vehicles, and a world-class paint facility ensures an exquisite finish for every vehicle we create.

BESPOKE BY SVO

Bespoke by SVO was born out of an innate understanding of what our most discerning clients value more than anything else – to own something completely unique to them. Something only they can have, reflecting who they are and what they hold most dear. With that in mind, SVO developed innovative Commissioning and Presentation suites enabling creation of the most refined and luxurious vehicles in the world. This special new facility is housed within the new SVO Technical Center in Warwickshire, England.



THE WORLD OF JAGUAR

Choose XJ and you're joining the exciting World of Jaguar.

ICE DRIVE EXPERIENCES

Take your driving to the next level with the Jaguar Land Rover Ice Drive Experience. Jaguar offers an adventure in Arjeplog, Sweden, that will test and develop your performance driving skills in extreme conditions. It's a rare chance for owners and enthusiasts to tackle some of the harshest and most challenging tracks on earth, under the skilled guidance of our experts. Our driving instructors are of the highest-caliber and will be with you every step of the way - ready to impart years of driving wisdom. You will dance on ice, glide around some of the most awe-inspiring corners imaginable and realize the true exhilarating potential of Jaguar and Land Rover vehicles.

If you'd like to be part of the next adventure, find out more by visiting jaguarusa.com

FORMULA E

The Jaguar reputation for performance, technology and design was forged by the world's most challenging circuits and championships. From Le Mans to Formula 1, and now Formula E, the grid is our test-bed. Formula E provides the perfect proving ground for electric vehicle technology in a high performance environment. The racing series accelerates the development of Jaguar's electric powertrains. With every race, Formula E helps Jaguar engineers create better electric vehicles.

BEHIND THE SCENES

Our factory tours give you the unique opportunity to experience the whole process of how our vehicles are brought to life - from the moulding of sheet metal to those intricate final touches. At our state-of-the-art production facilities, you'll get to see how skilled technicians and sophisticated machines work seamlessly together to perfect some of Jaguar's most breathtaking cars.

Find out more at jaguarusa.com

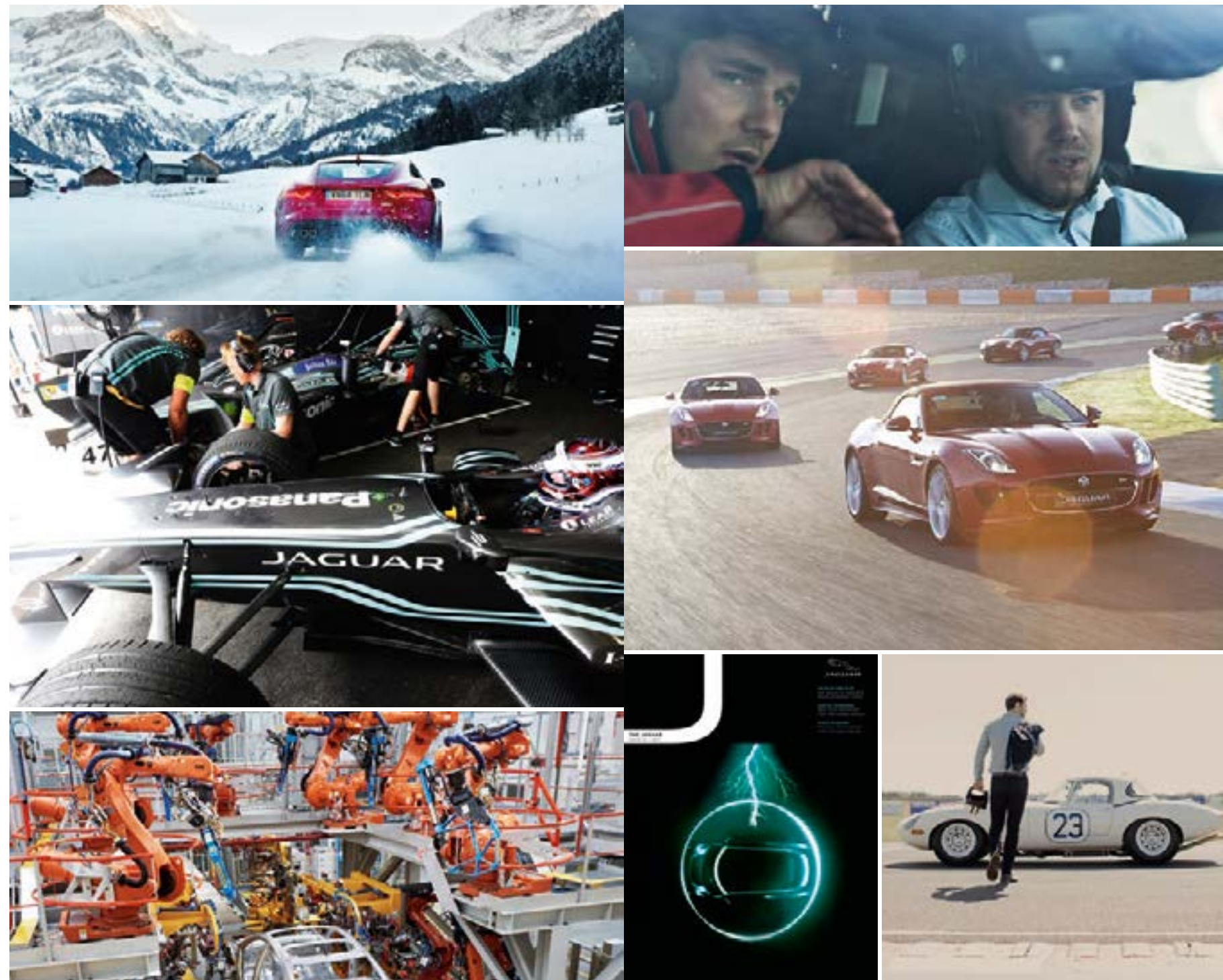

TRACK DAYS

There's no better way to get to know Jaguar than by taking a drive. The Jaguar Experience offers a range of unique opportunities to really find out what it feels like to get the most out of a Jaguar. Our track experiences allow you to push yourself and cars from the incredible Jaguar range to the limit.

Find out more by visiting jaguarusa.com

JAGUAR COLLECTION

The latest range from the Jaguar Collection has been crafted with the same design execution and attention to detail that goes into all of our cars. This is evident in our clothing range, premium leather items and luxury travel goods. To celebrate Jaguar's heritage, we also have a collection that honours past achievements and features race inspired gift items and apparel.

To find out more, visit the online shop at shop.jaguarusa.com

JAGUAR MAGAZINE

This is our own vibrant, cosmopolitan and contemporary magazine. Produced by a team of enthusiastic designers and feature writers, it goes behind the scenes at Jaguar as well as providing insight into the world of luxury, design, style and travel.



GLOSSARY

#

3D MAPPING
Three dimensional mapping is a selectable view mode in the navigation system. It provides an aerial view of the landscape with three dimensional buildings to greatly enhance user orientation.

7.1 SURROUND SOUND
7.1 Surround Sound is the common name for an eight-channel surround sound system.

A

ABS SYSTEM
The Anti-lock Braking System prevents wheel lock up under heavy braking to maintain vehicle control.

AIR SUSPENSION
Rear air suspension replaces conventional steel springs with pneumatic air springs to provide maximum ride comfort and control by automatically adjusting spring rates to suit the situation.

AUTO-DIMMING INTERIOR REAR VIEW MIRROR
Auto-dimming mirrors automatically reduce reflected glare from following cars' headlights.

D

DIGITAL SOUND PROCESSOR (DSP)
Meridian's Digital Signal Processing (DSP) technology analyzes a range of variables that may impact audio quality, then processes them using sophisticated algorithms and adapts the system's output accordingly. This enables a level of powerful, authentic performance impossible with a conventional sound system.

F

FOUR ZONE CLIMATE CONTROL
Adds independent automatic temperature control for left and right rear occupants in addition to the front dual zone.

H

HEAT-REFLECTIVE GLASS
This glass reflects infrared light waves and so reduces heat build-up inside the car caused by direct sunlight.

I

INTERACTIVE DRIVER DISPLAY
The Interactive Driver Display is a 12.3 inch High Definition TFT (Thin Film Transistor) screen that replaces the traditional instrument cluster. It displays a wide range of key driving information. Four graphical themes and a 3D map view are available.

J

JAGUAR SMART KEY SYSTEM - KEYLESS START
When the Smart Key is present in the car, simply push the Start button to start the engine.

JAGUARDRIVE CONTROL
Interacts with the Dynamic Stability Control system, engine and transmission management systems to alter the characteristics of the engine mapping, gear shifts and brakes. It offers different modes designed to optimize the vehicle's response to particular driving conditions and styles.

JAGUARDRIVE SELECTOR
The JaguarDrive Selector rises from the center console on start up. It is a rotary shifter used with automatic transmissions that allows you to quickly shift between drive modes.

L

LIMOUSINE RIDE SUSPENSION
For Long Wheelbase versions of the XJ, the rear air suspension has been specially recalibrated to optimize comfort, providing limousine like ride quality.

P

PSYCHOACOUSTICS
Psychoacoustics is the study of the psychological and physiological responses associated with listening to sound.

S

SOLAR ATTENUATING GLASS
This glass filters sunlight to reduce glare and prevent harmful UV rays from entering the cabin.

T

TRIFIELD™
Meridian's exclusive Trifield technology, delivers a consistent, concert-like experience, optimized for all seating positions.

W

WINTER MODE
By selecting Winter Mode, the system automatically dampens acceleration and applies more gradual torque for improved control in slippery conditions.

***DISCLAIMERS**

¹ Do not use Jaguar InControl® features under conditions that will affect your safety or the safety of others. Driving while distracted can result in loss of vehicle control.

² Driving while distracted can result in loss of vehicle control. Do not operate, adjust or view the navigation or multimedia systems under conditions that will affect your safety or the safety of others. Only use mobile phones, and other devices, even with voice commands, when it is safe to do so.

³ The Wi-Fi Hotspot is intended for passenger use only. Jaguar InControl® features may require an additional subscription with separate terms and conditions.

⁴ A 3-month trial subscription to the SiriusXM® All Access package is included with the vehicle, which gives you access to 175+ channels of premium programming. Plus you can stream SiriusXM® on your computer, smartphone or tablet - it's included in your trial. If you decide to continue service after your trial, the subscription plan you choose will automatically renew thereafter and you will be charged according to your chosen payment method at then-current rates. Fees and taxes apply. To cancel you must call SiriusXM® at 1-866-635-2349. See the SiriusXM® Customer Agreement for complete terms at siriusxm.com. All fees and programming are subject to change. SiriusXM® Satellite Radio is not available in Alaska, Hawaii, or Puerto Rico.

⁵ These features are not a substitute for driving safely with due care and attention and will not function under all circumstances, speeds, weather and road conditions, etc. Driver should not assume that these features will correct errors of judgment in driving. Please consult the owner's manual or your local Jaguar Retailer for more details.

⁶ Please remember that the safety belts in a vehicle constitute the primary protection system for driver and passengers in collisions. Airbags are not designed to deploy in all collisions. The airbag Supplemental Restraint System (SRS) is a supplement to the safety belts and is designed to work as a system with the safety belts. Although airbags provide additional protection, airbags without safety belts do not provide optimal protection in a crash. Always wear your safety belts. Children younger than 13 years old should always be properly restrained in a back seat, away from airbags. Never place an infant seat in the front seat.

⁷ Always follow local speed limits.

⁸ Class is cars sold by luxury automotive brands and claim is based on total package of warranty, maintenance and other coverage problems. For complete details regarding Jaguar EliteCare coverage, visit JAGUARUSA.COM, call 1.800.4.JAGUAR or visit your local Jaguar Retailer.

AT YOUR SERVICE

As well as providing a range of exclusive services and lifestyle products, the World of Jaguar makes owning and driving carefree and easy.

JAGUAR ELITECARE
Enjoy your Jaguar with complete peace of mind. The XJ is now backed by the Best-In-Class Jaguar EliteCare^{®9}, our exceptional 5 year / 60,000 mile coverage program including New Vehicle Limited Warranty, Complimentary Scheduled Maintenance, Roadside Assistance and Jaguar InControl® Remote & Protect™.

GENUINE PARTS
Jaguar Genuine Parts are designed, tested and manufactured to our uncompromising standards for quality, fit and durability. Each part is engineered specifically for your XJ to contribute to optimum performance and to help maximise its lifespan.

FLEET & BUSINESS
Jaguars are dynamic and distinctive cars that help companies express the unique character and personality of their business. We are committed to providing customer-focused aftersales services, ensuring that every Jaguar performs to the highest standard and in the most cost-efficient way for businesses. Visit jaguarusa.com for more information.

JAGUAR ASSISTANCE
Jaguar Assistance provides assistance in motoring emergencies, from immobilisation due to breakdown or accident to minor problems such as punctures. You can rely on our roadside assistance, whatever the situation, wherever you happen to be.

JAGUAR FINANCIAL SERVICES
New or used, for personal or business use, we have a finance option that puts you in complete control. Please speak to your local Jaguar Retailer to find out more.

IMPORTANT NOTICE
Jaguar Land Rover Limited is constantly seeking ways to improve the specification, design and production of its vehicles and alterations take place continually. While every effort is made to produce up-to-date literature, this brochure should not be regarded as an infallible guide to current specifications, nor does it constitute an offer for the sale of any particular vehicle. Distributors and Retailers are not agents of Jaguar Land Rover Limited by any express or implied undertaking or representation. Comparisons are based on manufacturer's own data and testing prior to publication.

COLORS
The colors reproduced here are subject to the limitations of the printing process and may therefore vary slightly from the actual vehicle. The company reserves the right to alter or withdraw any color finish without notice. Some of these colors may not be obtainable in your country. Please check availability of colors and current specifications with your Jaguar Retailer. Distributors and retailers are not agents of Jaguar Land Rover Limited and have absolutely no authority to bind Jaguar Land Rover Limited to any express or implied undertaking or representation.

ENVIRONMENTAL INNOVATION AT JAGUAR
Jaguar is committed to reducing dependency on fossil fuels, using fewer natural resources and creating less waste as part of our approach to responsible and sustainable business development.

Search 'Jaguar Environmental Innovation' for more details.

Meridian is the registered trademark of Meridian Audio Ltd.
AdBlue® is the registered trademark of the Verband der Automobilindustrie e. V. (VDA)
The Bluetooth® word mark and logos are owned by the Bluetooth SIG, Inc. and any use of such marks by Jaguar Land Rover Limited is under license.
iPod, iPod touch and iPad are trademarks of Apple Inc, registered in the US and other countries.
The navigation system must always be used in conditions that will not affect the driver's ability to drive safely or affect the safety of other road users.
Celeron, Centrino, Intel, the Intel logo, Intel Atom, Intel Core, Intel Inside, the Intel Inside logo, Intel vPro, Intel Xeon Phi, Itanium, Pentium, and Xeon are trademarks of Intel Corporation in the U.S and/or other countries.
Trifield and the "three fields" device is a trademark of Trifield Productions Ltd.

VEHICLE SHOWN FRONT AND BACK COVER: XJR575 STANDARD WHEELBASE IN SATIN CORRIS GREY WITH OPTIONAL EQUIPMENT

Jaguar Land Rover North America, LLC
555 MacArthur Boulevard
Mahwah, NJ 07430-2327
jaguarusa.com

© 2017 Jaguar Land Rover North America, LLC

1X3511810000BUSENO1P



